

**STATE OF VERMONT
AGENCY OF TRANSPORTATION**

Scoping Report

FOR

Worcester BF 0241(59)

VT Route 12, BRIDGE 84 Over the North Branch of Winooski River

June 12, 2020



Contents

I. SITE INFORMATION	3
NEED	3
TRAFFIC	4
DESIGN CRITERIA	4
INSPECTION REPORT SUMMARY	5
HYDRAULICS	5
UTILITIES	5
RIGHT-OF-WAY	6
RESOURCES.....	6
<i>Biological:</i>	6
<i>Historic:</i>	7
<i>Archaeological:</i>	7
<i>Hazardous Materials:</i>	7
<i>Stormwater:</i>	7
II. SAFETY	7
III. COMMUNITY NEEDS AND CONSIDERATIONS	7
IV. MAINTENANCE OF TRAFFIC.....	8
OFF-SITE DETOUR.....	8
TEMPORARY BRIDGE	8
PHASED CONSTRUCTION	9
V. ALTERNATIVES DISCUSSION	9
NO ACTION	9
ALTERNATIVE 1: MINOR REHABILITATION	9
ALTERNATIVE 2: DECK REPLACEMENT	10
ALTERNATIVE 2: SUPERSTRUCTURE REPLACEMENT	11
ALTERNATIVE 3: FULL BRIDGE REPLACEMENT ON-ALIGNMENT	11
V. ALTERNATIVES SUMMARY	13
VI. COST MATRIX	14
VII. CONCLUSION	15
VIII. APPENDICES	16
APPENDIX A: SITE PHOTOS.....	17
APPENDIX B: TOWN MAP	23
APPENDIX C: BRIDGE INSPECTION REPORT	25
APPENDIX D: PRELIMINARY HYDRAULICS REPORT	27
APPENDIX E: PRELIMINARY GEOTECHNICAL REPORT	30
APPENDIX F: RESOURCE ID COMPLETION MEMO	37
APPENDIX G: NATURAL RESOURCES MEMO	39
APPENDIX H: ARCHEOLOGICAL MEMO	59
APPENDIX I: HISTORIC MEMO	65
APPENDIX J: HAZARDOUS SITES MAP.....	72
APPENDIX K: COMMUNITY INPUT	74
APPENDIX L: OPERATIONS INPUT.....	79
APPENDIX M: CRASH DATA.....	82
APPENDIX N: UTILITY RESOURCE IDENTIFICATION	84
APPENDIX O: DETOUR ROUTES	86
APPENDIX P: PLANS.....	89

I. Site Information

Bridge 84 is a State-owned bridge located on VT Route 12 over North Branch in Worcester. The Bridge is located approximately 11.2 miles north of the junction of VT Route 12 and US Route 2. The existing conditions were gathered from a combination of a site visit, the Bridge Inspection Report, the Route Log and the existing survey. See correspondence in the Appendix for more detailed information.

Roadway Classification	Major Collector
Bridge Type	Single Span Rolled Beam Bridge
Bridge Length	84 feet
Bridge Skew	No Skew
Year Built	1936
Ownership	State of Vermont

Need

Bridge 84 carries VT Route 12 across North Branch and is considered Structurally deficient due to the deck rating. The following is a list of deficiencies of Bridge 84 and VT Route 12 at this location:

- The deck is in poor condition. The concrete is showing signs of significant distress with widespread rust staining, concrete scaling, saturation leakage and efflorescence leakage. There is one moderate size spall in bay #2 near the midspan. There is a wood catch form in Bay #4 where a previous spall has been covered. The poor deck condition radiates to the asphalt above which is also in poor condition with multiple patches, potholes, depressions and cracking. The fascia's are in poor condition with multiple areas of spalling with exposed thinning rebar, cracking and saturation leakage present.
- While the superstructure is rated as being in satisfactory condition, the paint system has failed. The Rolled beams have heavy paint distress with continuous paint failure with paint starting to peel, flake and bubble. Five (5) green painted rolled beams are ok condition with moderate rust scaling and neutral camber
- The substructures are in satisfactory condition, with the following maintenance needs:
 - Backwall: The reinforced concrete curtain walls have areas of moderate concrete scaling with heavy efflorescence leakage present in bays 1 and 3.
 - Southern Abutment: The reinforced concrete abutment has a full height vertical crack.
- VT Route 12 through the project area and over the bridge is substandard in width by 8 feet.

Traffic

A traffic study of this site was performed by the Vermont Agency of Transportation. The traffic volumes are projected for the years 2023 and 2043.

Traffic Data	2023	2043
AADT	1,500	1,700
DHV	230	260
ADTT	95	150
%T	6.0	8.8
%D	61	61

Design Criteria

The design standards for this bridge project are the Vermont State Standards, dated October 22, 1997. Minimum standards are based on an ADT of 1700, a DHV of 260, and a design speed of 50 mph for a Major Collector. VT Route 12 is considered a Low Use/Priority bicycle route at this area.

Design Criteria	Source	Existing Condition	Minimum Standard	Comment
Approach Lane and Shoulder Widths	VSS Table 5.3	10'/0' (20')	10'/4' (28') ¹	Substandard
Bridge Lane and Shoulder Widths	VSS Table 5.3	10'/0' (20')	10'/4' (28') ¹	Substandard
Clear Zone Distance	VSS Table 5.5	No Issues Noted	16' fill / 10' cut (1:3 slope) 12' cut (1:4 slope)	
Banking	VSS Section 5.13	NC over bridge	8% (max)	
Speed	VSS Section 5.3	50 mph (signed)	50 mph (Design)	
Horizontal Alignment	AASHTO Green Book, Table 3.10b	R = 1,000' (Southern Approach) R = 2,150' (Northern Approach)	R _{min} = 8,150' @ NC	Substandard at approach
Vertical Grade	VSS Table 576	4.8% (max) -2.38% over bridge	6% (max) for level terrain	
K Values for Vertical Curves	VSS Table 5.1	K _{sag} = 19 (northern approach), 198 (southern approach)	110 crest / 90 sag	Substandard
Vertical Clearance	VSS Section 5.8	No Issues Noted	14'-3"	
Stopping Sight Distance	VSS Table 5.1	129' (northern approach)	400'	Substandard
Bicycle/Pedestrian Criteria	VSS Table 5.8	No shoulder on bridge	4' Shoulder	Substandard
Bridge Railing	Structures Design Manual Section 13	W-Beam mounted on concrete posts	TL-2	Not Crash Tested
Hydraulics	VTrans Hydraulics Manual, Table 6.1	Passes 2% AEP storm event with 13.1' of freeboard Clearspan: 78'	Passes 2% AEP storm (Q ₅₀) event with 1' of freeboard Bank Full Width: 66'	
Structural Capacity	Structures Design Manual, Ch. 3.4.1	Structurally Deficient	Design Live Load: HL-93	Substandard

¹ Vermont State Standards specifies a typical section of 10'/3' (26') for safety and service. As per HSDEI 11-004, there shall be a minimum paved width of 28' for winter maintenance.

Inspection Report Summary

The ratings provided below are from the most recent inspection performed on April 5, 2019. The bridge is on a 12-month inspection frequency.

Deck Rating	4 Poor
Superstructure Rating	6 Satisfactory
Substructure Rating	6 Satisfactory
Channel Rating	8 Very Good

From the Structure Inspection, Inventory, and Appraisal Sheet:

4/5/2019 – Structure is in need of major rehab. Deck should be replaced because of heavy deterioration like spalling with exposed rebar, heavy saturation leakage, rust staining, delamination and cracking. Deck should be widened due to restriction in roadway width. Superstructure needs to be cleaned and repainted. ~SMP/JAS

4/9/2018 – Structure is in poor condition due to the deck. Deck will need replacement soon. Beams should be cleaned and painted. Spalling in the backwall on abutment #2 should be cleaned and patched. Should consider replacing the deck and paving soon. ~FRE/SMP

4/12/2017 – This structure needs to have a full deck replacement with extensive cleaning and painting of the beams. Due to continued saturation of the abutment 2 backwall, concrete repairs should be considered as well. ~JW/SP

4/14/2016 – Deck will need rehab or replacement in the near future. Beams should be cleaned and painted. ~FRE/TJB/JAS

Hydraulics

The existing structure passes the design flow of a 2% AEP (Q_{50}) with 13.07 feet of freeboard, which meets the current standards of the VTrans Hydraulic Manual. The current bridge provides a clear span of 78' which meets the minimum standard bank full width of 66'. The VTrans Hydraulics Section advises that either a rehabilitation or replacement option would be acceptable. See the preliminary hydraulics report in Appendix D for additional information.

Utilities

The VTrans Utilities and Permits unit investigated the existing utility within the project limits. The existing utilities identified are shown on the Existing Conditions Layout Sheet, and are as follows:

Municipal Utilities

- There are no municipal utilities at this location along VT Route 12.

Aerial Utilities

- Green Mountain Power, Comcast and Consolidated all have lines crossing the river just off the eastern edge of the bridge.

Underground Utilities

- There are no underground facilities at this location along VT Route 12.

It is anticipated that an aerial utility relocation will be necessary.

Right-Of-Way

The existing Right-Of-Way (ROW) is shown on the Existing Conditions Layout sheet in Appendix P. The existing southwest wingwall is located just outside the existing ROW. As such, it is anticipated that additional ROW will be required for any construction project.

Resources

The resources present at this project are shown on the Existing Conditions Layout Sheet and are based on information provided by VTrans, and are as follows:

Biological:

Wetlands/Watercourses

The bridge crosses the North Branch of the Winooski River.

There are three wetland areas within the project area. These are located in the Northwest, southwest, and southeast quadrants of the bridge. A description of each of these wetlands can be found on page 3 of the Natural Resources Assessment Report found in Appendix G.

Wildlife Habitat

There is a mapped Vt. Fish and Wildlife deer winter habitat in the study area.

Vt. Fish and Wildlife identifies the study area as a Highest Priority wildlife crossing and Highest Priority surface water and riparian area in the Vt. Conservation Design Community and Species Scale Components. The forest surrounding the study area is relatively unfragmented with varying habitat types and considerable compositional and structural diversity

Rare, Threatened and Endangered Species

According to the ANR Natural Resource mapping there are no known occurrences of rare, threatened or endangered species within proximity of the project study area.

The project is within the northern long-eared bat, *Myotis septentrionalis* (state endangered, federally T) range. No documented roosts or hibernacula are within 1 mile of the project area. Potential suitable habitat for this species varies. Typically, suitable habitat consists of trees (dead or alive) ≥ 3 " dbh that exhibit cracking, peeling bark, holes, crevices, and bridges, etc. There is adjacent potential suitable habitat along the riparian corridor. Once project plans are developed, and the amount of tree cutting is determined the VTrans biologist will further assess what needs to be completed for studies to determine effect on this species.

Agricultural

According to NRCS soils mapping on the ANR Natural Resource Atlas, Rumney (Statewide (b)) and Machias (Statewide (b)) fine sandy loams are mapped in the central and southern Project area. These soil types are both frequently flooded but not considered highly erodible.

Historic:

There are no historic resources located within the project area. See the Historic ID Memo in Appendix I for additional information.

Archaeological:

Most of the project area is steep and rocky, leaving few areas for preservation. However, the space near the river surface may have the foundations of the old sawmill below the soil surface. For this reason, the flood plain should be avoided. See the Archaeology Memo in Appendix H for additional information.

Hazardous Materials:

According to the Vermont Agency of Natural Resources (VANR) Vermont Hazardous Sites List, there is one hazardous waste sites located in close proximity to the project area. The site is designated as JOE AUDET AUTO & TRUCK SALES INC and is located approximately 1,000 feet south of the bridge on VT Route 12. See the figure to the right for a map of Hazardous Sites.

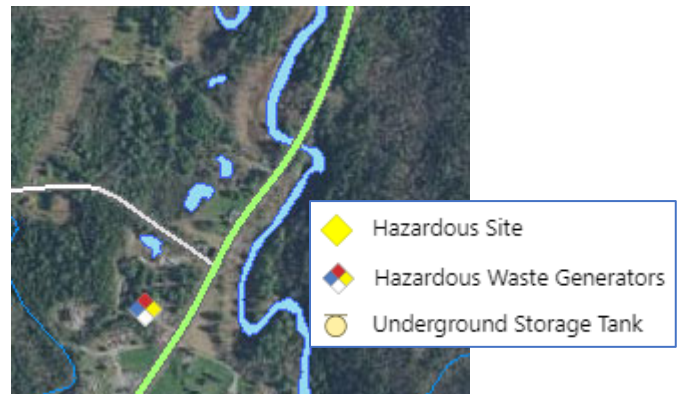

Stormwater:

There are no stormwater concerns at this site.

II. Safety

There have been 33 crashes located along VT Route 12 in Worcester within the last 5-year period. Two of these crashes are located within close proximity to Bridge 84.

There are no High Crash Location segments located within the project area.

III. Community Needs and Considerations

A community questionnaire was sent to the Town and Regional Planning Commission to fill out. Responses to the questionnaire can be found in Appendix K. The following needs and considerations were gathered from the Town's responses:

- The Town has indicated that there is a heavy amount of pedestrian traffic and bicycle traffic over the bridge.
- The Town feels that the bridge is too narrow and that the narrow width is an issue.

IV. Maintenance of Traffic

The Vermont Agency of Transportation reviews each new project to determine suitability for the Accelerated Bridge Program which focuses on faster delivery of construction plans, permitting and Right-of-Way, as well as faster construction of projects in the field. One practice that will help in this endeavor is closing bridges for portions of the construction period, rather than maintaining traffic on a portion of the existing bridge during construction or providing temporary bridges. In addition to saving money, the intention is to minimize the closure period with faster construction techniques and incentives to contractors to complete projects sooner. The Agency will consider the closure option on most projects where rapid reconstruction or rehabilitation is feasible. The use of prefabricated elements in new bridges will also expedite construction schedules. This can apply to decks, superstructures and substructures. Accelerated Construction provides enhanced safety for the workers and the traveling public while maintaining project quality.

Off-Site Detour

This option would close the bridge and reroute traffic onto an official, signed State detour. There are two detours that could be used if the bridge is closed during construction. The two potential State-signed detours are as follows:

1. VT Route 12, to VT Route 100, and US Route 2, back to VT Route 12 (61 miles end-to-end)
2. VT Route 12, to US Route 2, VT Route 14, and VT Route 15, back to VT Route 12 (66 miles end-to-end)

There are no local bypass routes available. Access to driveways and town highways would be maintained. A map of the detour routes can be found in the appendix.

Advantages: Utilizing an off-site detour would eliminate the need to use a temporary bridge or phase construction to maintain traffic. This would decrease the cost and amount of time required to construct a project in this location. The impacts and amount of temporary rights required to construct a project in this location would also be reduced for this option. The safety of both construction workers and the travelling public will be improved by removing traffic from the construction site.

Disadvantages: Traffic flow would not be maintained through the project corridor during construction.

Temporary Bridge

From a constructability standpoint, a temporary bridge could be placed on either the upstream or downstream side. There is a house located in close proximity to the bridge on both the upstream and downstream side. A temporary bridge on the downstream side would have greater impacts to utilities and would require the relocation of aerial utilities. A significant amount of tree clearing would be required for construction of a temporary bridge on either the upstream or the downstream side.

Based on the daily traffic volumes and length of the bridge, a one-way temporary bridge with alternating traffic controlled by a signal would be recommended. A layout of the temporary bridge can be seen in the scoping plan set in Appendix P.

Advantages: A temporary bridge will maintain traffic flow through the project corridor during construction.

Disadvantages: This traffic control option would be costly and time consuming, as construction activities could require a second construction season in order to construct the temporary bridge and approaches. There would be decreased safety for workers and vehicular traffic because of cars driving near the construction site and construction vehicles entering and exiting the construction site.

Phased Construction

Another method of maintaining traffic along the corridor during construction is to build a new structure one lane at a time, or in phases. Construction activities could be phased but would have significant impacts to traffic particularly for the phase of work that requires the contractor to maintain traffic on each side of their construction operations. For a bridge with an AADT of 1,500 vehicles per day, and a DHV of 230 vehicles per hour, it is acceptable to close one lane of traffic, and maintain one lane of traffic, both ways, with a traffic signal. While the current bridge width is narrow, it is possible to phase traffic here if the new structure is widened to the upstream side of the road.

Advantages: This would maintain traffic along the existing corridor during construction.

Disadvantages: The time required to construct a phased construction project is longer than a project constructed without phasing, because some of the construction tasks have to be performed multiple times and cannot be performed concurrently. The costs of construction also increase over un-phased work because of this increase in the length of time, the additional inconvenience of working around traffic, and the effort involved in coordinating the joints between the phases. Once again, while the corridor will be open to traffic during construction, traffic will still be delayed and disrupted by the shifting of lanes and by construction vehicles and equipment entering and exiting the site. The construction workers and equipment will still be in close proximity to vehicular traffic increasing the probability of crashes and injuries.

V. Alternatives Discussion

No Action

This alternative would involve leaving the bridge in its current condition. A good rule of thumb for the “No Action” alternative is whether the bridge can stay in place without any work being performed on the bridge in the next 10 years. The existing bridge is structurally deficient. The existing concrete deck is in poor condition, with future pop-outs and emergency repairs possible at any time. In the interest of safety to the traveling public, the No Action alternative is not recommended. A cost estimate has not been provided for this alternative since there are no immediate costs.

Alternative 1: Minor Rehabilitation

This rehabilitation option includes the minimal amount of work necessary to extend the useful life of the bridge. Any loose concrete on the underside of the deck would be removed and replaced.

After removing the deteriorated and loose concrete from the structure, patching materials can be placed to replace the removed concrete. A disadvantage with this method of rehabilitation in this situation, is that having newer non-chloride laced materials adjacent to the existing concrete can

exacerbate the rate of deterioration of the remaining concrete which surrounds the patch. This can be mitigated for approximately 15 years with the addition of sacrificial anodes into the patched structure.

This alternative would also include bridge seat repairs and substructure repairs as needed. All of the bridge deck joints would be replaced with flexible joint material and a new membrane and pavement would be installed.

Most of this work can be accomplished without impacting traffic on VT Route 12. Individual lanes may need to be closed during replacement of the joints and while a membrane and pave is occurring.

This alternative would address the deterioration issues of the existing bridge. However, the substandard bridge geometry would not be addressed.

Alternative 2: Deck Replacement

A deck replacement for this bridge would include a new deck and railings, with superstructure and substructure repairs as follows:

- The existing deck would be removed, and a new cast-in-place deck would be poured.
- The existing rolled beams are rusting and have areas of minor section loss. This alternative would include cleaning and painting the existing beams.
- There is a full height vertical crack in the northern abutment. This crack should be stabilized and repaired.
- The backwalls have areas of moderate concrete scaling with localized heavy efflorescence leakage present. New backwalls should be poured.
- A silane application should be applied to all exposed substructure concrete as part of the project.

The existing substructures are in Satisfactory condition, and it is reasonable to assume that with the repairs listed above, the existing substructure and beams can safely carry anticipated traffic loads for an additional 40 years. The existing abutments are poured directly on bedrock and there are no concerns with scour.

The existing lane widths and shoulders on the bridge consist of 10-foot-wide lanes with no shoulders. This does not meet the minimum standard of 28 feet rail-to-rail. It is proposed that 10-foot lanes and 2-foot shoulders be constructed for this alternative. Utilizing a fascia mounted railing detail, the standard typical section can be achieved without significantly widening the deck on either side.

Advantages: This alternative would address the immediate concerns of the poor deck condition with minimal upfront cost. The effects on the adjacent properties, resources, and wildlife would be minimal. The width of the existing bridge could be widened to a 24-foot width rail-to-rail typical.

Disadvantages: This alternative would remain substandard in width. The Town has indicated that there is heavy bicycle and pedestrian use here. The paint system on the steel beams has failed, necessitating beam painting, which is relatively costly. The anticipated design life of this option would be 40 years.

Maintenance of Traffic: Traffic could be maintained on an offsite detour or a temporary bridge. The width of the deck is too narrow for phased construction.

Alternative 3: Superstructure Replacement

A superstructure replacement option for this bridge would include a new deck, railings, and superstructure, with substructure repairs as follows:

- There is a full height vertical crack in the northern abutment. This crack should be stabilized and repaired.
- The existing bridge seats would be cut down and new bridge seats would be poured to accommodate the new superstructure. This would include replacing the deteriorating backwall at both abutments.
- A silane application should be applied to all exposed substructure concrete as part of the project.

The existing substructure is in satisfactory condition, and it is reasonable to assume that with the repairs listed above, the existing substructure can safely carry anticipated traffic loads for an additional 40 years. The existing abutments are poured directly on bedrock and there are no concerns with scour.

The existing lane widths and shoulders on the bridge consist of 10-foot-wide lanes with no shoulders. This does not meet the minimum standard of 28 feet rail-to-rail. It is proposed that 10-foot lanes and 3-foot shoulders be constructed for this alternative. Utilizing a fascia mounted railing detail, the standard typical section can be achieved without significantly widening the deck on either side.

Advantages: This alternative would address the immediate concerns of poor deck condition and would eliminate maintenance concerns for the beams with minimal cost. The effects on the adjacent properties, resources, and wildlife would be minimal. The width of the bridge would also be slightly widened. This option would also replace the deteriorated backwalls at both abutments.

Disadvantages: This alternative would remain substandard in width. The Town has indicated that there is heavy bicycle and pedestrian use here. The anticipated design life of this option would be 40 years.

Maintenance of Traffic: Traffic could be maintained on an offsite detour or a temporary bridge. The width of the deck is too narrow for phased construction.

Alternative 4: Full Bridge Replacement ON-Alignment

A full bridge replacement would include replacing all bridge components: the deck, superstructure, railing, and substructure at the existing location and provides the full 75-year service life estimated for new bridge construction. The various considerations for this option include the roadway alignment, bridge width and length, skew, superstructure type and substructure type.

a. *Alignment*

The bridge is located on a straight tangent along VT Route 12. While the southern approach curve is substandard, there is a house located in close proximity to the road on the inside of the curve. Flattening the curve to meet the minimum standard at the approach would require removal of that house, and as such will not be explored further. Therefore, it is recommended that the horizontal alignment matches existing.

b. *Bridge Width*

The minimum standard roadway width is 28 feet. Since a new 75+ year bridge is being proposed, the bridge geometry should meet the minimum standards and match the corridor width. A rail-to-rail width of 28-feet to match the existing conditions of the corridor and meet the minimum standard will be proposed. This will allow for two 10-foot lanes with 4-foot shoulders.

c. *Bridge Length and Skew*

The existing bridge is 84 feet in length with no skew. The current bridge provides a hydraulic clearspan of approximately 78 feet. This clearspan meets the minimum bankfull width required for hydraulics. If a new bridge is constructed is recommended that it meet the minimum hydraulic standard and provide a minimum clear span of 66 feet. A single span bridge with an approximate 70-foot length is recommended. In order to match the existing conditions of the channel, the new bridge would not have a skew.

d. *Superstructure Type*

If traffic is to remain open during construction, a cast in place deck on steel beams is the most cost-effective superstructure type. If an offsite detour is the chosen traffic control, then a prefabricated structure would be recommended to reduce the closure duration. The possible 70-foot length prefabricated bridge types that are most commonly used in Vermont are a steel and composite concrete deck (also known as PBU's), or NEXT beams. The superstructure depth is not critical for meeting hydraulic standards, so the superstructure type shall be determined during the design phase.

e. *Substructure Type*

The existing abutments are spread footings bearing directly on bedrock. Additionally, bedrock is visible in the channel both upstream and downstream of the existing bridge. Based on previous projects and water well logs, identified in the geotechnical report, shallow bedrock will be encountered. Based on available subsurface information, the abutments will likely be spread footings bearing on bedrock.

f. *Maintenance of Traffic*

The possible options for this alternative are an offsite detour, a temporary bridge, or phased construction.

V. Alternatives Summary

Based on the existing site conditions, bridge condition, and recommendations from hydraulics, there are several viable alternatives:

- Alternative 1a: Minor Rehabilitation with Traffic Maintained on Temporary Lane Closures
- Alternative 2a: Deck Replacement with Traffic Maintained on an Offsite Detour
- Alternative 2b: Deck Replacement with Traffic Maintained on a Temporary Bridge
- Alternative 3a: Superstructure Replacement with Traffic Maintained on an Offsite Detour
- Alternative 3b: Superstructure Replacement with Traffic Maintained on a Temporary Bridge
- Alternative 4a: Full Bridge Replacement with Traffic Maintained on an Offsite Detour
- Alternative 4b: Full Bridge Replacement with Traffic Maintained on a Temporary Bridge
- Alternative 4c: Full Bridge Replacement with Traffic Maintained with Phased Construction

VI. Cost Matrix²

Worcester BF 0241(59)		Do Nothing	Alternative 1	Alternative 2		Alternative 3		Alternative 4		
			Minor Rehabilitation	Deck Replacement		Superstructure Replacement		Full Bridge Replacement		
			Temporary Lane Closures	a. Offsite Detour	b. Temporary Bridge	a. Offsite Detour	b. Temporary Bridge	a. Offsite Detour	b. Temporary Bridge	c. Phased Construction
COST	Bridge Cost	\$0	169,100	412,200	412,200	773,800	323,500	1,260,300	846,500	1,070,800
	Removal of Structure	\$0	0	73,920	73,920	73,920	73,920	138,600	138,600	159,390
	Roadway	\$0	65,000	231,000	231,000	244,000	216,000	276,000	289,000	434,000
	Maintenance of Traffic	\$0	19,040	169,300	344,040	169,300	344,040	169,300	344,040	271,600
	Construction Costs	\$0	253,140	886,420	1,061,160	1,261,020	957,460	1,844,200	1,618,140	1,935,790
	Construction Engineering & Contingencies	\$0	75,942	265,926	318,348	189,153	191,492	368,840	404,535	425,874
	Accelerated Premium	\$0	0	62,049	0	88,271	0	129,094	0	0
	Total Construction Costs w CEC	\$0	329,082	1,214,395	1,379,508	1,538,444	1,148,952	2,342,134	2,022,675	2,361,664
	Preliminary Engineering ³	\$0	75,942	88,642	106,116	252,204	335,111	276,630	323,628	387,158
	Right of Way	\$0	5,000	5,000	25,000	5,000	25,000	5,000	25,000	5,000
	Total Project Costs	\$0	410,024	1,308,037	1,510,624	1,795,648	1,509,063	2,623,764	2,371,303	2,753,822
Annualized Costs	\$0	27,335	32,701	37,766	44,891	37,727	34,984	31,617	36,718	
TOWN SHARE		No Local Share	No Local Share	No Local Share		No Local Share		No Local Share		
TOWN %										
SCHEDULEING	Project Development Duration ⁴	N/A	2 years	2 years	4 years	2 years	4 years	4 years	4 years	4 years
	Construction Duration	N/A	2 months	4 months	12 months	4 months	12 months	6 months	18 months	9 months
	Closure Duration (If Applicable)	N/A	N/A	30 days	N/A	30 days	N/A	45 days	N/A	N/A
ENGINEERING	Typical Section - Roadway (feet)	20'	20'	24'	24'	24'	24'	28'	28'	28'
	Typical Section - Bridge (feet)	0'-10'-10'-0' (20')	0'-10'-10'-0' (20')	2'-10'-10'-2' (24')		3'-10'-10'-3' (26')		4'-10'-10'-4' (28')		
	Geometric Design Criteria	Substandard Width	Substandard Width	Substandard Width		Substandard Width		Meets Minimum Standard for Width		
	Traffic Safety	No Change	Improved	Improved	Improved	Improved	Improved	Improved	Improved	Improved
	Alignment Change	No Change	No Change	No Change	No Change	No Change	No Change	No Change	No Change	No Change
	Bicycle Access	Substandard	Substandard	Improved - Substandard		Improved - Substandard		Improved - Meets Minimum Standard		
	Pedestrian Access	Substandard	Substandard	Improved - Substandard		Improved - Substandard		Improved - Meets Minimum Standard		
	Hydraulics	Meets Minimum Standard	Meets Minimum Standard	Meets Minimum Standard	Meets Minimum Standard	Meets Minimum Standard	Meets Minimum Standard	Meets Minimum Standard	Meets Minimum Standard	Meets Minimum Standard
Utilities	No Change	No Change	Aerial Relocation		Aerial Relocation		Aerial Relocation			
OTHER	ROW Acquisition	No	Yes	Yes	Yes	Yes	Yes	Yes	Yes	Yes
	Road Closure	No	No	Yes	No	Yes	No	Yes	No	No
	Design Life (years) ⁵	<10	15	40	40	40	40	75	75	75

² Costs are estimates only, used for comparison purposes.

³ Preliminary Engineering costs are estimated starting from the end of the Project Definition Phase.

⁴ Project Development Durations are starting from the end of the Project Definition Phase.

⁵ A design life of 40 years will be assumed for the deck and superstructure replacement options based on the existing substructure rating of "Satisfactory". A design life of 75 years will be assumed for the Full Bridge Replacement Options.

VII. Conclusion

We recommend **Alternative 4b or 4c**; a full bridge replacement while one lane of alternating traffic is maintained during construction.

Structure:

While the substructures are in satisfactory condition, the bridge is almost 84 years old which exceeds the expected design life. Additionally, the full bridge replacement option is the only option that would bring the bridge up to the minimum standard width. While the rehabilitation options have a lower upfront cost, the full bridge replacement option has a lower annualized cost. The full bridge replacement option will address the condition of the deck and provide a new 75-year structure.

By choosing to replace the bridge, the width of the roadway through the project area can be widened on each side to accommodate bicycle traffic, with 4-foot shoulders as per the Vermont State Standards. The new structure will provide a rail-to-rail roadway width of 28-feet, to meet the minimum standard typical section as set forth in the Vermont State Standards.

A new bridge would have a design life of 75 years. Spread Footings bearing directly on bedrock have been assumed based on the presence of observed shallow bedrock.

Traffic Maintenance:

The regional detour routes available have an end-to-end distance of approximately 60 miles, with no local bypass routes available. This distance is considered relatively long for a detour route, and as such, traffic should be maintained through the project area. The recommended method of traffic control is to either construct a temporary bridge to one side of the existing structure or to construct the new bridge in phases. There will be one lane of alternating traffic with a traffic signal maintained during construction.

Additional Considerations:

Utilities:

Green Mountain Power, Comcast and Consolidated all have lines crossing the river just off the eastern edge of the bridge. Aerial utilities will need to be relocated prior to construction; coordination should take place early in the design phase.

Coordination with other projects:

There are several projects in the State Highway Bridge Program within the project area that are currently in the scoping phase of project development. The projects are as follows:

- ELMORE BF 0241(55) 19B212, VT Route 12, Bridge 94 over unnamed brook.
- ELMORE STP CULV(64) 18B003, VT Route 12, Bridge 90 over unnamed brook.
- WORCESTER BF 0241(56) 19B213, VT Route 12, Bridge 87 over Hardwood brook.
- WORCESTER BF 0241(57) 19B214, VT Route 12, Bridge 89 over North brook.
- WORCESTER BF 0241(59) 86E053, VT Route 12, Bridge 84 over the north branch of Winooski river

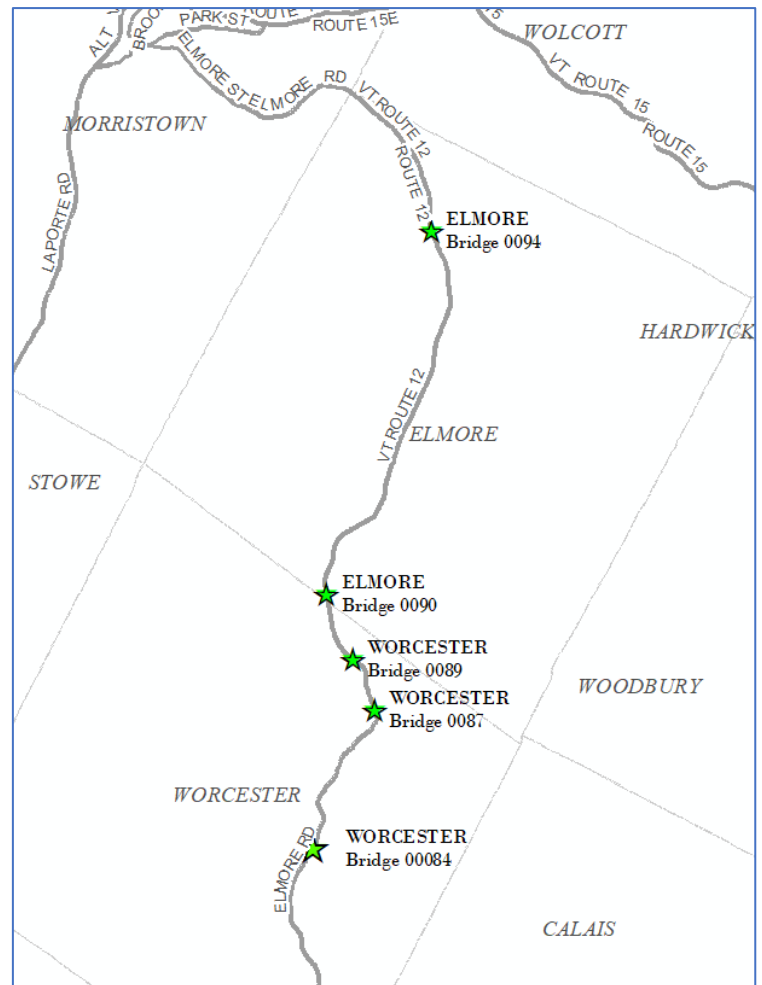

Consideration should be given to bundling these projects for design and/or construction.

VIII. Appendices

- Appendix A: Site Pictures
- Appendix B: Town Map
- Appendix C: Bridge Inspection Report
- Appendix D: Hydraulics Memo
- Appendix E: Preliminary Geotechnical Information
- Appendix F: Resource ID Completion Memo
- Appendix G: Natural Resources Memo
- Appendix H: Archeology Memo
- Appendix I: Historic Memo
- Appendix J: Hazardous Sites Map
- Appendix K: Community Input
- Appendix L: Operations Input
- Appendix M: Crash Data
- Appendix N: Utility Resource Identification
- Appendix O: Detour Routes
- Appendix P: Plans

Appendix A: Site Photos



Photo 1: Looking South over Bridge 84



Photo 2: Looking North over Bridge 84



Photo 3: Looking Upstream from Bridge 84



Photo 4: Looking Downstream from Bridge 84 (note old bridge abutments)



Photo 5: Southern Abutment



Photo 6: Northern Abutment

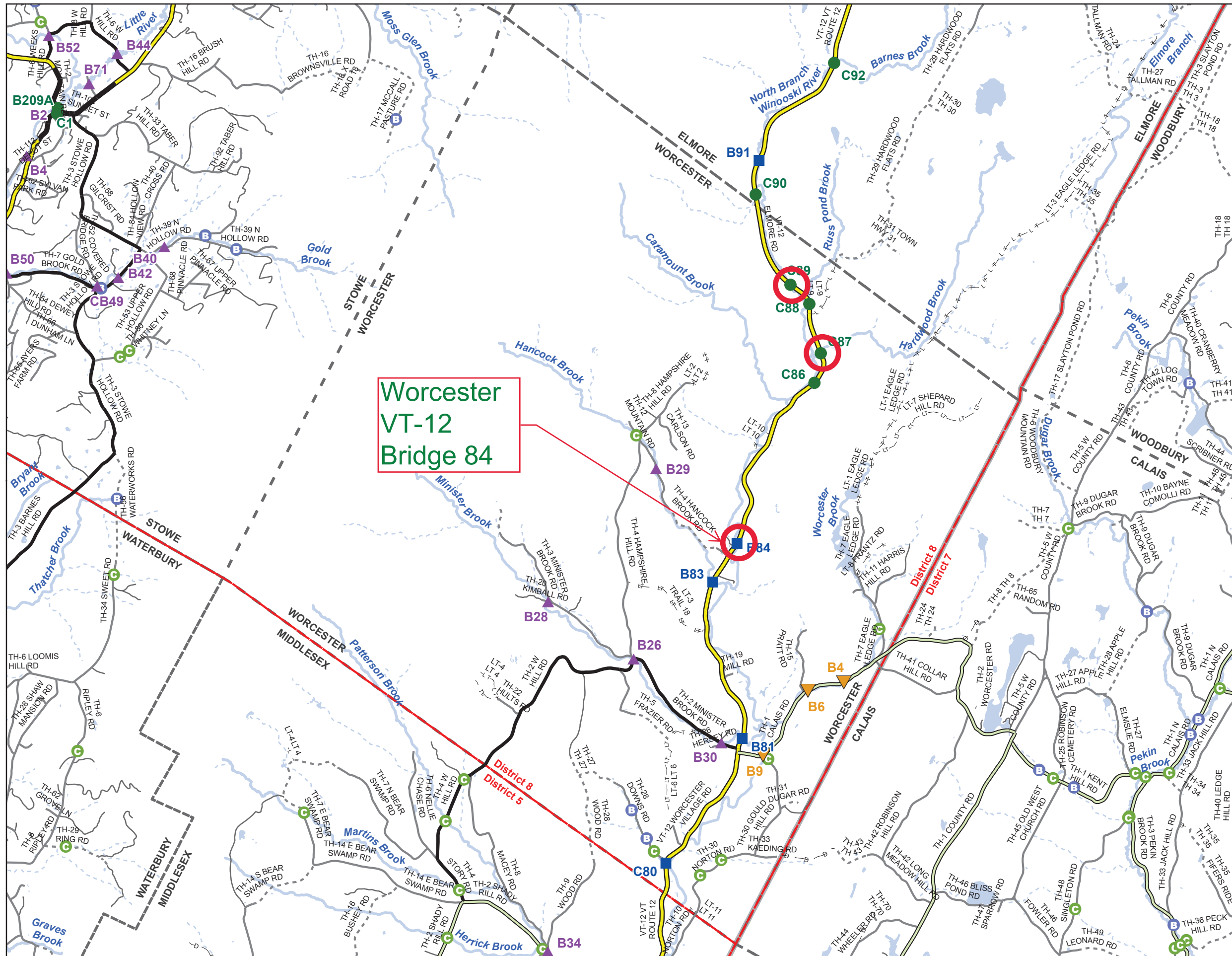

Photo 7: Spalling in deck (Note deck repairs and paint failure at beams)



Photo 8: Backwall Leakage

Appendix B: Town Map



Scale: 1:60,330

- ★ INTERSTATE
- STATE LONG
- STATE SHORT
- ▲ TOWN LONG
- ▼ FAS/FAU
- ◆ BIKE PATH
- INTERSTATE
- STATE HIGHWAY
- CLASS 1
- CLASS 2
- CLASS 3
- CLASS 4
- - - LEGAL TRAIL
- - - PRIVATE
- - - DISCONTINUED
- FAS/FAU HWY
- MAINTENANCE DISTRICT
- POLITICAL BOUNDARY
- VTRANS REGION BOUNDARY
- NAMED RIVER-STREAM
- - - UNNAMED RIVER-STREAM
- B Point from Local Bridge Data *
- C Point from Local Culvert Data *

* Points are from local town bridge and culvert inventories. Some points may overlap where VTrans has also conducted an inventory on the Town highway.
Data source: VOBICIT aka VTCulverts

Produced by:
Mapping Section
Division of Policy, Planning and
Intermodal Development
Vermont Agency of Transportation
May 2017

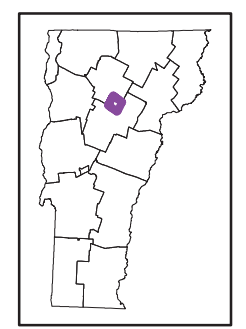

WORCESTER
COUNTY-TOWN CODE: 1220-0
WASHINGTON COUNTY
DISTRICT # 8
District Long Name: St. Albans District
VTrans Four Region: Northwest

This map was funded in part through grants from the Federal Highway Administration, U.S. Department of Transportation. The representation of the authors expressed herein do not necessarily state or reflect those of the U. S. Department of Transportation.

Appendix C: Bridge Inspection Report

STRUCTURE INSPECTION, INVENTORY and APPRAISAL SHEET

Vermont Agency of Transportation ~ Structures Section ~ Bridge Management and Inspection Unit

Inspection Report for WORCESTER

bridge no.: 00084

District: 8

Located on: VT 00012 ML over NORTH BRANCH

approximately 11.2 MI N JCT. U.S.2

Owner: 01 STATE-OWNED

CONDITION

Deck Rating: 4 POOR
Superstructure Rating: 6 SATISFACTORY
Substructure Rating: 6 SATISFACTORY
Channel Rating: 8 VERY GOOD
Culvert Rating: N NOT APPLICABLE
Federal Str. Number: 200241008412202
Federal Sufficiency Rating: 077.6
Deficiency Status of Structure: SD

STRUCTURE TYPE and MATERIALS

Bridge Type: ROLLED BEAM
Number of Approach Spans: 0000 Number of Main Spans: 001
Kind of Material and/or Design: 3 STEEL
Deck Structure Type: 1 CONCRETE CIP
Type of Wearing Surface: 6 BITUMINOUS
Type of Membrane: 0 NONE
Deck Protection: 0 NONE

AGE and SERVICE

Year Built: 1936 Year Reconstructed: 0000
Service On: 1 HIGHWAY
Service Under: 5 WATERWAY
Lanes On the Structure: 02
Lanes Under the Structure: 00
Bypass, Detour Length (miles): 04
ADT: 001000 % Truck ADT: 06
Year of ADT: 1998

APPRAISAL *AS COMPARED TO FEDERAL STANDARDS

Bridge Railings: 1 MEETS CURRENT STANDARD
Transitions: 1 MEETS CURRENT STANDARD
Approach Guardrail: 1 MEETS CURRENT STANDARD
Approach Guardrail Ends: 1 MEETS CURRENT STANDARD
Structural Evaluation 6 EQUAL TO MINIMUM CRITERIA
Deck Geometry: 3 INTOLERABLE, CORRECTIVE ACTION NEEDED
Underclearances Vertical and Horizontal: N NOT APPLICABLE
Waterway Adequacy: 8 SLIGHT CHANCE OF OVERTOPPING ROADWAY

GEOMETRIC DATA

Length of Maximum Span (ft): 0082
Structure Length (ft): 000084
Lt Curb/Sidewalk Width (ft): 0
Rt Curb/Sidewalk Width (ft): 0
Bridge Rdwy Width Curb-to-Curb (ft): 20.3
Deck Width Out-to-Out (ft): 23.5
Appr. Roadway Width (ft): 022
Skew: 00
Bridge Median: 0 NO MEDIAN
Min Vertical Clr Over (ft): 99 FT 99 IN
Feature Under: FEATURE NOT A HIGHWAY OR RAILROAD
Min Vertical Underclr (ft): 00 FT 00 IN

Approach Roadway Alignment: 8 EQUAL TO DESIRABLE CRITERIA

Scour Critical Bridges: 8 STABLE FOR SCOUR

DESIGN VEHICLE, RATING, and POSTING

Load Rating Method (Inv): 1 LOAD FACTOR (LF)
Posting Status: A OPEN, NO RESTRICTION
Bridge Posting: 5 NO POSTING REQUIRED
Load Posting: 10 NO LOAD POSTING SIGNS ARE NEEDED
Posted Vehicle: POSTING NOT REQUIRED
Posted Weight (tons):
Design Load: 2 H 15

INSPECTION and CROSS REFERENCE X-Ref. Route:

Insp. Date: 042019 Insp. Freq. (months) 12 X-Ref. BrNum:

INSPECTION SUMMARY and NEEDS

4/5/2019 Structure is in need of major rehab. Deck should be replaced because of heavy deterioration like spalling with exposed rebar, heavy saturation leakage, rust staining, delamination and cracking. Deck should be widened due to restriction in roadway width. Superstructure needs to be cleaned and repainted. SMP & JAS

4/9/2018 Structure is in poor condition due to the deck. Deck will need replacement soon. Beams should be cleaned and painted. Spalling in the backwall on abutment #2 should be cleaned and patched. Should consider replacing the deck and paving soon. ~FRE/SMP

4/12/2017 This structure needs to have a full deck replacement with extensive cleaning and painting of the beams. Due to continued saturation of the abutment 2 backwall, concrete repairs should be considered as well. JW/SP

4/14/2016 Deck will need rehab or replacement in the near future. Beams should be cleaned and painted. ~FRE/TJB/JAS

Appendix D: Preliminary Hydraulics Report

**State of Vermont
Structures and Hydraulics Section**

One National Life Drive
Montpelier, Vermont 05633-5001
vtrans.vermont.gov

[phone] 802-371-7326
[fax] 802-828-3566
[ttd] 800-253-0191

Agency of Transportation

TO: Laura Stone, Structures, Scoping Engineer

CC: Nick Wark, Hydraulics Engineer

FROM: Jeff DeGraff, Hydraulics Project Engineer

DATE: April 21, 2020

SUBJECT: Worcester BF0241(59) pin #86e053
Worcester, VT-12 Br84, over North Branch Winooski River
Site location: Worcester VT-12, Elmore Road, MM 3.973
Coordinates: [44.403405, -72.550532](#)

We have completed our hydraulic study for the above referenced site, and offer the following for your use:

On 12/11/19 we met with ANR at the site. In an email on 12/12/19 they indicated a minimum span of 66-feet should be used to span bankfull width (BFW).

VT-12 is a Major Collector. The Design Storm Flow is 2% AEP (Q50).

All freeboard reported within this memo used an average low beam elevation of 816.74 feet. Note that the freeboard reported within this memo should be used for general purposes. The superstructure's depth for each alternative may change with respect to structure type, abutment skew, pier configuration and etc.

The following was analyzed:

Existing Conditions: 84-foot Single Span Rolled Beam Bridge

- Provides approximately 13.07-feet of freeboard at the design AEP

Option 1: 66-foot clear span bridge

- For this analysis we assumed that the southern abutment will be replaced in kind.
- There is approximately 13.03-feet of freeboard at the design AEP
- Does not appear to increase upstream 100-year base flood elevations
- Does not appear to increase the floodplain horizontal extents
- Will need to coordinate with ANR Stream Alterations and Floodplains. This option is the most drastic change likely allowable.

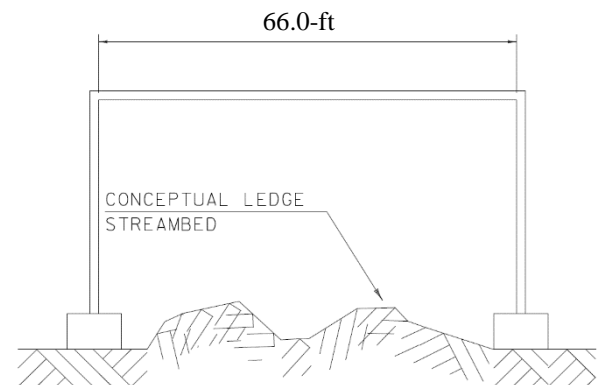

Option 1: Typical Section

The existing abutments are bearing directly on bedrock. Bedrock is visible in the main channel both upstream and downstream of the existing bridge. For these reasons, a preliminary scour analysis and countermeasure design was not performed. If subsurface investigations are performed and indicate that existing bedrock is erodible or erosive soils are encountered, an updated/detailed scour analysis will be performed during the final hydraulics phase.

Bridge 84 is located within a FEMA Special Flood Hazard Area (SFHA) Zone AE with Base Flood Elevations.

Option 1 will encroach the existing floodplain which will trigger Flood Hazard Area & River Corridor Rule (FHA&RC) General Permit at a minimum. Further coordination will be needed in order to determine if the permanent impacts from the proposed project would constitute an individual permit and if compensatory storage will need to be considered as part of this project. Furthermore, this analysis did include any temporary impacts associated with construction fill and/or a temporary bridge.

Please contact us with any questions, or to check substructure configuration scenarios.

Appendix E: Preliminary Geotechnical Report

To: Nick Wark, P.E., P.I.I.T. Program Manager
SPM CEE

From: Stephen Madden, Geotechnical Engineer, via Callie Ewald, P.E., Geotechnical Engineering Manager

Date: September 19th, 2019

Subject: Worcester BHF 0241(59) Preliminary Geotechnical Information

1.0 INTRODUCTION

As requested, we have completed our preliminary geotechnical investigation of Bridge No. 84 on VT Route 12 over the North Branch of the Winooski River in the Town of Worcester, VT. Bridge No. 84 is located approximately 11.2 miles north of the junction of VT Route 12 with US Route 2. The subject project consists of replacing or rehabilitating the existing single-span, rolled beam with a cast-in-place concrete deck bridge. The project is currently in the scoping phase. This review included the examination of as-built record plans, historical in-house bridge boring files, water well logs and hazardous site information on-file at the Vermont Agency of Natural Resources (ANR), published surficial and bedrock geologic maps, and observations made during a site visit.

2.0 SUBSURFACE INFORMATION

2.1 Published Geologic Data

Mapping conducted in 1970 for the Surficial Geologic Map of Vermont shows that the project area consists of glaciolacustrine deposits, consisting primarily of gravel, and glacial till deposits (Doll, 1970).

According to the 2011 Bedrock Map of Vermont, published by the USGS and State of Vermont, the project site is underlain with granofels and quartzite of the Moretown Formation (Ratliffe, et. al, 2011).

The Geotechnical Engineering Section maintains a GIS based historical record of subsurface investigations, which contains electronic records for the majority of borings completed in the past 10 years. An exploration of this database revealed no nearby projects within a 0.5-mile radius of the project site.

2.2 Water Well Logs

The Vermont ANR documents and publishes all water wells that are drilled for residential or commercial purposes. Published online, these logs may provide general characteristics of the soil strata and depth to bedrock in the area. The three closest recorded water wells were TAG 54953, TAG 0811062695 and WRN 28 located approximately 100 ft, 790 ft, and 1,140 ft from the project site, respectively. Bedrock was reported at a depth of 5 ft and 116 ft for wells TAG 54953 and TAG 0811062695, respectively. Well TAG 53-247-94 did not report bedrock to a termination depth of 45 ft.

2.3 Hazardous Materials and Underground Storage Tanks

The ANR Natural Resource Atlas also maps the location and information of known hazardous waste sites and underground storage tanks. The location of this project is not on the Hazardous Site List. No underground storage tanks are located within a 1.0-mile radius and no impact from other hazardous waste sites is anticipated. A hazardous waste generator site, Joe Audet Auto & Truck Sales, Inc., is located approximately 0.25 miles south of the project location however this site is not expected to impact construction activities.

2.4 Record Plans

Record plans for the project, dated December 1935, were reviewed as part of this investigation. The plans included layout and profile sheets and abutment detail sheets. The abutment detail sheets indicate that the concrete abutments and wingwalls are founded on spread footings bearing directly on bedrock and include bottom of footing elevations across the abutment and wingwall profiles.

3.0 FIELD OBSERVATIONS

A preliminary site visit was conducted on September 12th, 2019 to identify possible obstructions inhibiting boring operations and to make any other pertinent observations about the project. Overhead utilities run parallel with VT Route 12 to the east of the roadway, as seen in Figures 3.1 and 3.2. We do not anticipate that these overhead utilities will restrict boring operations however a minimum safe distance from the drilling equipment will be required to be maintained during drilling operations and should be considered during the planning of a subsurface investigation. Exposed bedrock was visible throughout the project site, within the riverbed and embankments, and at the bottom of abutment and wingwall locations, as seen in Figures 3.3 through 3.6.



Figure 3.1: Facing north along VT Route 12; note overhead utilities to east of roadway.



Figure 3.2: Facing south along VT Route 12; note overhead utilities to east of roadway.



Figure 3.3: Facing upstream; note exposed bedrock throughout including at wingwall location.



Figure 3.4: *Facing southern abutment; note exposed bedrock at bottom of footing elevations for abutment and wingwalls.*



Figure 3.5: *Facing downstream; note exposed bedrock throughout.*



Figure 3.6: Facing northern abutment outlet; note exposed bedrock at bottom of footing elevation for abutment.

4.0 RECOMMENDATIONS

4.1 Preliminary Foundation Alternatives

Based on the information reviewed during this investigation, if a full bridge replacement option is chosen as the preferred alternative foundation options for a replacement structure include the following:

- Precast or steel arch bridge with spread footings founded on bedrock
- Semi-integral abutments founded on spread footings on bedrock

4.2 Proposed Subsurface Investigation

If a full replacement of the bridge is chosen as the preferred alternative we recommend a minimum of two borings be advanced at each abutment in order to more fully assess the subsurface conditions at the site including, but not limited to, the soil properties, depth to and characteristics of bedrock, and groundwater conditions. Based on the exposed bedrock visible at the site, additional borings or bedrock probes will likely be required to profile the bedrock elevation across the footprint of the proposed structure. Based on the topography of the site borings will likely need to be advanced from within the travel lanes and shoulders of the roadway of VT Route 12. Geophysical methods may be advantageous here to get a full picture of the bedrock surface for design and construction.

Prior to the development of project plans, we recommend that the Agency Geologist be contacted to provide a thorough geologic assessment of the bedrock on this project. This

assessment should include an evaluation of the quality of the bedrock as well as other critical design parameters such as orientation and the condition of any jointing or other discontinuities which may have an impact on the design of the abutments and wingwalls. We will coordinate this effort and recommend this work be performed in conjunction with the boring program.

5.0 CLOSING

When a design alternative as well as a preliminary alignment has been chosen, the Geotechnical Engineering Section can assist in designing a subsurface investigation that efficiently gathers adequate information for the alternative chosen.

If you have any questions or would like to discuss this report, please contact us by phone at (802) 828-2561.

6.0 REFERENCES

Doll, C. G., 1970, Surficial Geologic Map of Vermont, Vermont Geological Survey, Montpelier, VT.

Ratliffe, N. M., Stanley, R. S., Gale, M. H., Thompson, P. J., Walsh, G. J., 2011, Bedrock Geologic Map of Vermont, Vermont Geological Survey, Montpelier, VT.

Vermont Agency of Natural Resources Department of Environmental Conservation, Natural Resources Atlas, www.anr.vermont.gov/maps/nr-atlas%20, accessed 9/17/2019.

cc: Laura Stone, P.E., P.I.I.T. Project Engineer
Electronic Read File/MG
Project File/CEE
SPM

[Z:\Highways\CMB\GeotechEngineering\Projects\Worcester BHF 0241\(59\)\REPORTS\Worcester BHF 0241\(59\) Preliminary Geotechnical Information.docx](Z:\Highways\CMB\GeotechEngineering\Projects\Worcester BHF 0241(59)\REPORTS\Worcester BHF 0241(59) Preliminary Geotechnical Information.docx)

Appendix F: Resource ID Completion Memo



OFFICE MEMORANDUM
AOT - PDB - ENVIRONMENTAL SECTION

RESOURCE IDENTIFICATION COMPLETION MEMO

TO: Laura Stone, Project Manager
FROM: Jeff Ramsey, Environmental Specialist Supervisor
DATE: 11/05/19
Project: Worcester BF 0241 (59)

ENVIRONMENTAL RESOURCES:

Archaeological Site:	<input checked="" type="checkbox"/> Yes	<input type="checkbox"/> No	<u>See Archaeological Resource ID Memo</u>
Historic/Historic District:	<input checked="" type="checkbox"/> Yes	<input type="checkbox"/> No	<u>See Natural Resources Assessment Report</u>
Wetlands:	<input checked="" type="checkbox"/> Yes	<input type="checkbox"/> No	<u>See Natural Resources Assessment Report</u>
Agricultural Land:	<input checked="" type="checkbox"/> Yes	<input type="checkbox"/> No	<u>See Natural Resources Assessment Report</u>
Fish & Wildlife Habitat:	<input checked="" type="checkbox"/> Yes	<input type="checkbox"/> No	<u>See Natural Resources Assessment Report</u>
Wildlife Habitat Connectivity:	<input checked="" type="checkbox"/> Yes	<input type="checkbox"/> No	<u>See Natural Resources Assessment Report</u>
Endangered Species:	<input checked="" type="checkbox"/> Yes	<input type="checkbox"/> No	<u>See Natural Resources Assessment Report</u>
Stormwater:	<input type="checkbox"/> Yes	<input checked="" type="checkbox"/> No	
6(f) Property:	<input type="checkbox"/> Yes	<input checked="" type="checkbox"/> No	
Hazardous Waste/ ANR Urban Background Soils:	<input type="checkbox"/> Yes	<input checked="" type="checkbox"/> No	
USDA-Forest Service Lands:	<input type="checkbox"/> Yes	<input checked="" type="checkbox"/> No	
Scenic Highway/ Byway:	<input type="checkbox"/> Yes	<input checked="" type="checkbox"/> No	
Act 250 Permits:	<input type="checkbox"/> Yes	<input checked="" type="checkbox"/> No	
FEMA Floodplains:	<input type="checkbox"/> Yes	<input checked="" type="checkbox"/> No	
Flood Hazard Area/ River Corridor:	<input checked="" type="checkbox"/> Yes	<input type="checkbox"/> No	<u>Project may require a Flood Hazard Area River Corridor permit depending on project scope and impacts.</u>
US Coast Guard:	<input type="checkbox"/> Yes	<input checked="" type="checkbox"/> No	
Lakes and Ponds:	<input type="checkbox"/> Yes	<input checked="" type="checkbox"/> No	
303D List/ Class A Water/ Outstanding Resource Water:	<input type="checkbox"/> Yes	<input checked="" type="checkbox"/> No	
Surface and Ground Water (SPA) Source Protection Area:	<input type="checkbox"/> Yes	<input checked="" type="checkbox"/> No	
Groundwater Classification:	<input type="checkbox"/> Yes	<input checked="" type="checkbox"/> No	
Public Water Sources/ Private Wells:	<input type="checkbox"/> Yes	<input checked="" type="checkbox"/> No	
Other:	<input checked="" type="checkbox"/> Yes	<input type="checkbox"/> No	<u>Invasive species - See Natural Resources Assessment Report</u>

cc:
 Project File

Appendix G: Natural Resources Memo

**Natural Resources Assessment Report for
Vermont Agency of Transportation
Worcester BF 0241 (59)**

Worcester, Vermont

*Prepared by:
Arrowwood Environmental, LLC*

October 18, 2019



ARROWWOOD ENVIRONMENTAL

950 BERT WHITE ROAD
HUNTINGTON, VT 05462
(802) 434-7276 FAX: (802) 329-2253

**Natural Resources Assessment Report for
Vermont Agency of Transportation
Worcester BF 0241 (59)**

Table of Contents

	Page #
I. Introduction and Project Description.....	2
II. Site Characterization.....	2
III. Wetlands	3
IV. Rare, Threatened and Endangered Species.....	4
V. Non-Native Invasive Species (NNIS).....	6
VI. Streams	6
VII. Wildlife Habitat and Habitat Connectivity	7
VIII. Agricultural Soils.....	9

Appendices

- Appendix 1: Photo Log
- Appendix 2: Resource Map
- Appendix 3: Wetland Delineation Forms
- Appendix 4: Wetland Function and Value Forms
- Appendix 5: Plant Species List
- Appendix 6: Stream Summary Forms

**Natural Resources Assessment Report for
Vermont Agency of Transportation
Worcester BF 0241 (59)**

I. Introduction and Project Description

Arrowwood Environmental, LLC (AE) was retained by the Vermont Agency of Transportation to perform a natural resources assessment for the proposed Culvert 86 project between mile markers 3.9 and 4 along Route 12 in Worcester, Vermont. The study area for the assessment is shown in Appendix 2 on the Resource Map.

The assessment consisted of a remote landscape analysis of the study area as well as a field assessment. The field assessment was conducted on September 10, September 13 and September 16, 2019. This Natural Resource Assessment Report summarizes the results of the remote analysis and field assessment.

II. Site Characterization

Ecologically the site is within the Northern Green Mountains biophysical region of the state (Thompson and Sorenson, 2000). The study area is located at approximately 900 feet above mean sea level according to U.S. Geologic Survey (“USGS”) topographic data. The mapped bedrock that is underlying the site is granofels and quartzite from the Moretown Formation. (Ratcliffe et al. 2011). The soils are mapped as Rumney and Machias soils which are fine sandy loams (NRCS Soil Survey). The surrounding landscape is dominated by forest land and rural residential development.

Much of the study area consists of mowed roadside dominated by herbaceous vegetation. The upland forests in the study area consist of Hemlock-Northern Hardwood forests and Northern Hardwood Forests. Three wetlands (described below) are also present within the study area.

III. Wetlands

The wetland assessment involved both a remote review of available maps (including Vermont Significant Wetland Inventory Maps and the NRCS Soil Survey) and a field inventory component conducted on September 10, 2019. The protocols put forth in the USACE's *Corp of Engineers Wetlands Delineation Manual* (2009 Regional Supplement for the Northcentral and Northeast Region) were employed for delineating wetlands as is the standard practice in Vermont. Three wetlands were mapped within the study area and shown on the Resource Map in Appendix 2. Wetland classifications have not been determined with the Vermont Wetlands Office. Wetland delineation data forms and functions and values assessments for each of these wetlands are included in Appendices 3 and 4, respectively.

Wetland A: Wetland A is a Seepage wetland along the banks of the North Branch Winooski River. The wetland extends to the south along the North Branch and outside of the study area. Wetland vegetation is dominated by a mix of shrub and young sapling hardwood species (willow species, red maple, American elm) and wetland soils are characterized by alluvial silt loams. The wetland is not contiguous with a mapped VSWI Class 2 wetland but is presumed to be Class 2 due to size and association with the North Branch.

Wetland B: Wetland B is an Alluvial Shrub Swamp located in the floodplain of the North Branch Winooski River. Wetland vegetation is dominated by shrub species (willow species) and wetland soils are characterized by frequently flooded silt loams. The wetland extends to the north along the River and out of the study area. The wetland is not contiguous with a mapped VSWI Class 2 wetland but is presumed to be Class 2 due to size and association with the North Branch.

Wetland C: Wetland C is characterized as an Alluvial Shrub Swamp located in the floodplain of the North Branch Winooski River. The wetland extends out of the study area to the northwest along the North Branch. Wetland vegetation is dominated by shrub species (willow species) and wetland soils are characterized by frequently flooded silt loams. The wetland is a VSWI mapped Class 2 Wetland.

IV. Rare, Threatened and Endangered Species

The RTE species review involved both a remote review of available digital maps for the study area as well as a field survey. AE reviewed digital orthophotography, the NRCS Soil Survey, the 2011 Bedrock Geologic Map of Vermont and the Wildlife Natural Heritage Inventory (NHI) Rare, Threatened and Endangered Species digital database.

In reviewing the NHI digital database, there are no records or occurrences of RTE plant or animal species in or directly adjacent to the study area.

Plant Species

An inventory for RTE and uncommon plant species was undertaken in the study area on September 13, 2019. No RTE or uncommon plants were identified during the survey of the study area. A complete list of plants documented during that inventory is presented in Appendix 5.

Animal Species

The Northern Long Eared Bat (*Myotis septentrionalis*, MYSE) became a federally listed endangered species in May of 2015. The State of Vermont has determined that project clearing greater than 1% of the total forested area within a 1 square mile radius of a project triggers greater review for habitat loss for this endangered species. Although the specific details of the proposed project at this location are unknown, it is located in an extensively forested environment with approximately 1400 acres of forest within a 1 mile radius. The Project would require more than 14 acres of clearing before reaching the 1% threshold triggering MYSE related restrictions or further review.

The study area was reviewed for the presence of trees that may provide potential summer roost habitat for MYSE. Two trees with features that could support MYSE roosting were documented during the field investigation. Although project clearing is unlikely to trigger MYSE related restrictions or further review, the preservation of these potential roost trees would help insure avoidance of any impacts to MYSE.

MYSE, Indiana Bat (*Myotis sodalist*, MYSO, federal & Vt. endangered, not found in this region of Vermont) and in some cases the little brown bat (*Myotis lucifugus*, MYLU, Vt. endangered) and tri-colored bat (*Perimyotis subflavus*, PESU, Vt. endangered) are known to utilize bridges for summer day, night, and occasionally, maternal roost sites. The existing bridge structure includes

characteristics which may support roosting by endangered bats, most notably crevices and cracks in the existing bridge abutments at heights greater than 10' off the ground. The bridge abutments at this setting are located in a relatively deep and shaded gorge, which may limit the thermal benefits to bat roosting, but the upstream open floodplain and open water of the river suggest preferable bat feeding habitat. Prior to work commencing on this structure, focused investigation such as repeated site inspections and exit surveys, potentially paired with acoustic monitoring are recommended. If bats are found to be utilizing the structure, mitigatory measures should be employed in coordination with the Vt. Department of Fish & Wildlife. Of additional note, the masonry (stone) bridge abutments from a prior bridge located just downstream of the subject structure may also provide bat roosting opportunities and similar measures should be taken for any disturbance or significant activity at that location.

No other RTE animal species are documented nearby or are expected to be impacted by the proposed project.

V. Non-Native Invasive Species (NNIS)

A non-native invasive plant species is considered to be a species which has become established outside of its native range and grows aggressively enough to threaten native ecological communities. For the purposes of this study, a NNIS plant is any species listed as a Class A or Class B noxious weed by the Vermont Noxious Weed Quarantine Rule or a plant on the Vermont Invasive Exotic Plant Committee Watch List. An inventory for non-native invasive plant species was conducted on September 16, 2019.

Four NNIS species comprising thirteen populations were mapped at this site and are presented on the attached Resource Map. The populations are described as follows:

N-1	<i>Anthriscus sylvestris</i>	wild chervil	10% cover under an apple tree
N-2	<i>Aegopodium podagraria</i>	wild chervil	Patch escaping from private yard
N-3	<i>Anthriscus sylvestris</i>	wild chervil	5% cover on bridge abutment
N-4	<i>Fallopia japonica</i>	Japanese knotweed	Edge of private yard
N-5	<i>Fallopia japonica</i>	Japanese knotweed	5% cover on in-channel bar
N-6	<i>Anthriscus sylvestris</i>	wild chervil	2 plants under apple tree
N-7	<i>Lonicera morrowii</i>	Morrow's honeysuckle	5% cover along stream bank
N-8	<i>Anthriscus sylvestris</i>	wild chervil	1 plant
N-9	<i>Fallopia japonica</i>	Japanese knotweed	Large patch in woods on steep slope
N-10	<i>Anthriscus sylvestris</i>	wild chervil	30% cover along road edge
N-11	<i>Lonicera morrowii</i>	Morrow's honeysuckle	1 plant
N-12	<i>Phalaris arundinacea</i>	Reed canary grass	15% cover through wetland to stream
N-13	<i>Anthriscus sylvestris</i>	wild chervil	5% cover along road

VI. Streams

The stream assessment involved both a remote review of the USGS topographic map, Vermont Hydrography Dataset (streams, rivers, and waterbodies), LiDAR derived elevation data, and field investigation on September 10, 2019. The North Branch Winooski River and a small tributary stream were mapped in the study area and are summarized below. Stream data summaries are provided in Appendix 6.

North Branch Winooski River: The existing bridge (Culvert 86) crosses the North Branch Winooski River. At the structure the river is characterized as a steep step pool system with average bankfull channel width of approximately 35' to 40' (estimated) and bedrock and boulder substrate. The river is confined by a bedrock at the bridge. There is a large scour pool downstream of the structure and a beaver dam upstream of the structure.

Unnamed Tributary Stream: An unnamed stream that flows into the North Branch is located in the northern study area. The hydrology of this intermittent stream appears to be from surface water runoff related the road ditching system along Route 12. The stream channel substrate is dominated by coarse gravel substrate. Average bankfull channel width is approximately 4'.

VII. Wildlife Habitat and Habitat Connectivity

The wildlife habitat assessment involved both a remote review of available digital maps for the study area and a field inventory component. A remote review of available digital databases was conducted to identify potentially necessary wildlife habitat within the study area and within the vicinity of the study area.

There is a mapped Vt. Fish and Wildlife deer winter habitat in the study area. The deer winter habitat boundary is inaccurately mapped to the edge of the road north of the structure where a residential house and yard is present. Significant deer activity or forest with the structural composition necessary for deer winter habitat was not observed in the study area. The forest to the east of the study area is composed primarily of hemlock on steep slopes and this area may support wintering deer.

Vt. Fish and Wildlife identifies the study area as a Highest Priority wildlife crossing and Highest Priority surface water and riparian area in the Vt. Conservation Design Community and Species Scale Components. The forest surrounding the study area is relatively unfragmented with varying habitat types and considerable compositional and structural diversity. The roadway cuts tightly through the surrounding forest north of the study area, while opening to more residential and light commercial development to the south. There are varying elevation changes between road edge and surrounding forest which may in places present moderate barriers to habitat connectivity. An active beaver dam was located directly upstream of the structure at the time of evaluation. The

river enters a small gorge at the structure and drops in elevation and remains incised and narrow as it continues downstream, however the area upstream holds larger floodplains and wetlands which appear conducive to a variety of terrestrial and semi-aquatic wildlife species including waterfowl, muskrat, beaver, mink and otter. The gorge likely presents a natural impediment to aquatic organism passage and may be somewhat further affected by the presence of the structure with the southern abutment on bedrock at the edge of the channel serving to concentrate and confine flow during high water. The stone abutments of a historic bridge are located just downstream of the existing structure and may further limit dispersed flow and terrestrial wildlife passage opportunities at this location. During low flow, the channel itself allows some wildlife passage opportunity under the road on exposed bedrock, but this is most likely inconsistent due to the confined banks and large pool at the outfall of the small gorge. More appealing road crossing opportunities exist north of the structure, although these areas put wildlife at greater risk of vehicular collision. Opportunities for improved aquatic and terrestrial passage may be limited at this site due to the nature of the surrounding landscape, existing development, and geomorphological conditions. If the southern abutment were moved further out of the channel resulting in a longer bridge span, terrestrial passage may be slightly improved, but it may not be significant. Wildlife crossing strategies in this area may provide more benefit if focused in the area north of the study area.

Concentrated amphibian crossing areas occur when different amphibian habitat features are separated from each other by roads. Typical habitat features include wetland/vernal pool breeding habitats and upland habitats, or, in some cases, different wetland feeding habitats. Movement typically occurs on warm rainy nights in the spring and early summer. Depending on surrounding land-use and the position of the different habitat features, this amphibian movement can be concentrated and involve hundreds or thousands of individuals. When this concentrated movement occurs across a busy road, mass mortality of amphibians can occur. While minor amphibian movement can occur scattered across the landscape, this movement rarely results in mass amphibian mortality or traffic difficulties. For this reason, it is the concentrated amphibian crossing areas that are of a concern.

The Seepage and Alluvial Shrub Swamp wetlands identified in the project area do not provide vital breeding habitat for most amphibians. Due to the nature of these wetlands, no areas of concentrated amphibian movement are likely present.

Stream salamanders are likely present in the study area in the Seepage wetlands and along the North Branch and wetlands mapped. Based on the habitats present, these species likely include spring salamanders (*Gyrinophilus porphyriticus*), northern dusky salamanders (*Desmognathus fuscus*) and northern two-lined salamanders (*Eurycea bislineata*). For these species only limited movement occurs outside of the stream corridor and mass migrations do not occur. Since these species rarely cross roads, they do not pose a management concern as concentrated amphibian crossing areas. However, since they do migrate within the stream corridor, management for these species at this road crossings is best achieved by adhering to the AOP Guidelines for bridge construction.

VIII. Agricultural Soils

The agricultural soils assessment involved a remote review of the NRCS County Soil Survey for the Project area. Primary agricultural soils were identified in the central and southern Project area and are presented on the attached Resource Map. Primary soil types present include Rumney (Statewide (b)) and Machias (Statewide (b)) fine sandy loams. These soil types are both frequently flooded but not considered highly erodible.

Appendix 1

Photo Log



Upstream of structure looking downstream. Cracks in abutment may provide bat roosting.
September 10, 2019



Downstream of structure looking upstream
September 10, 2019



Wetland A (Photo Right)
September 10, 2019



Wetland B (Photo right) and
Wetland C (photo left and back)
with beaver dam spanning the
North Branch
September 10, 2019



Potential Bat Roost Tree
September 10, 2019

Appendix 2

Resource Map

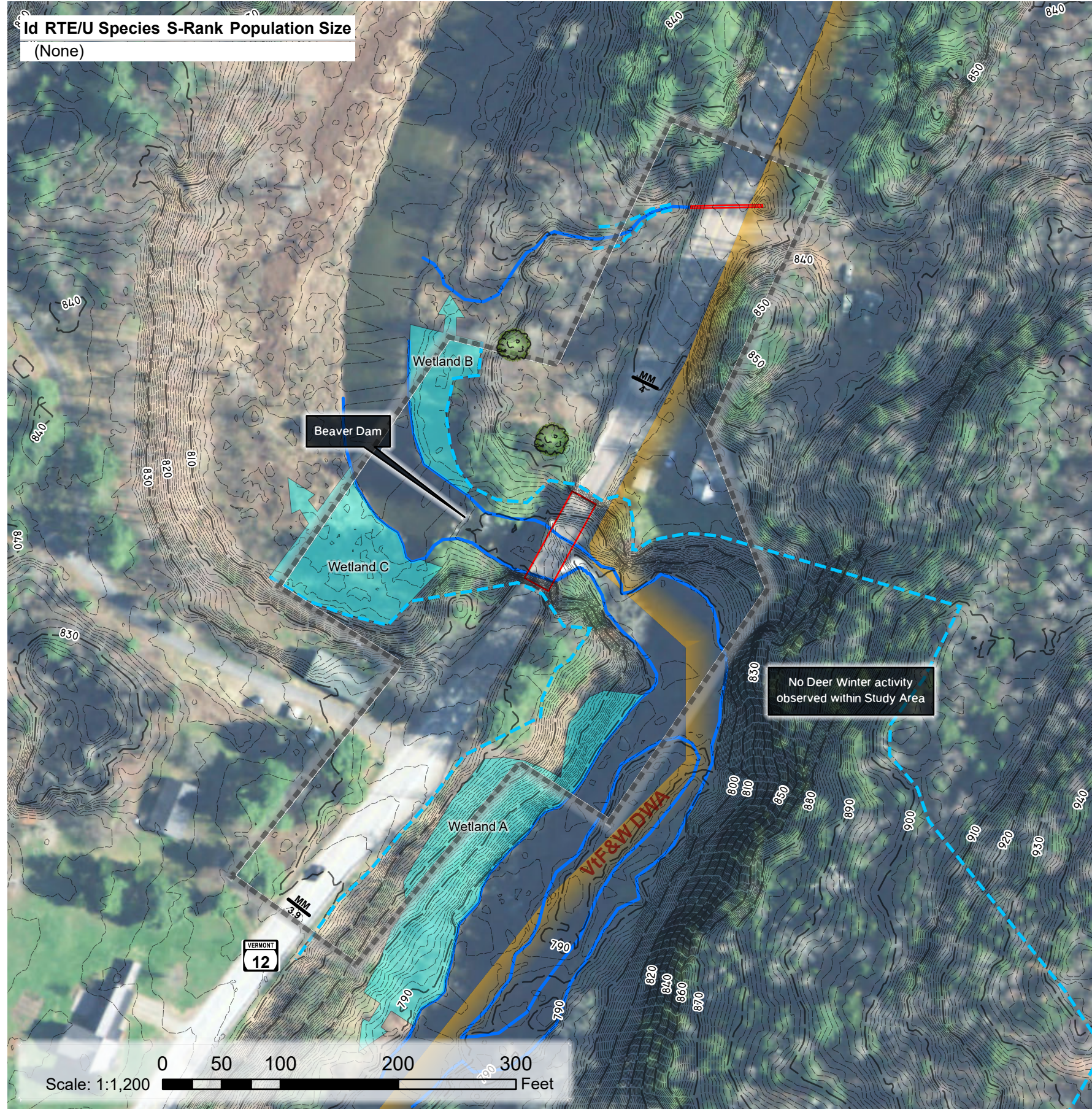

Id RTE/U Species S-Rank Population Size
(None)

No Deer Winter activity
observed within Study Area

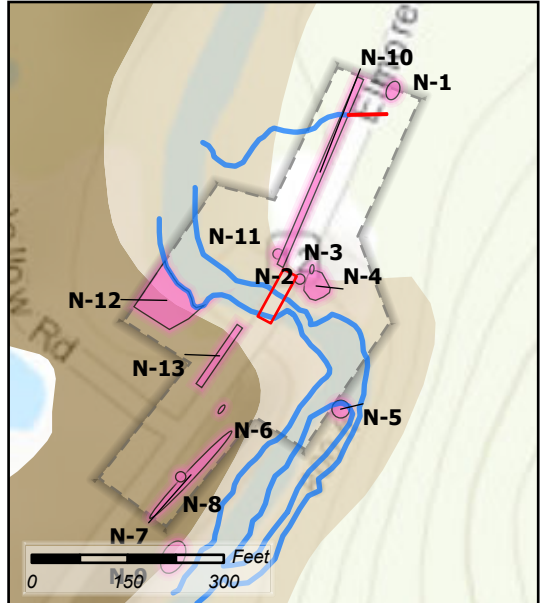

Non-native Invasive Species (NNIS)

Prime Ag Soils: Statewide Ag Soils:

NNIS Populations at this Site

NNIS ID	Species	NNIS ID	Species
N-1	Anthriscus sylvestris	N-4	Fallopia japonica
N-10	Anthriscus sylvestris	N-5	Fallopia japonica
N-11	Lonicera morrowii	N-6	Anthriscus sylvestris
N-12	Phalaris arundinacea	N-7	Lonicera morrowii
N-13	Anthriscus sylvestris	N-8	Anthriscus sylvestris
N-2	Aegopodium podagraria	N-9	Fallopia japonica
N-3	Anthriscus sylvestris		

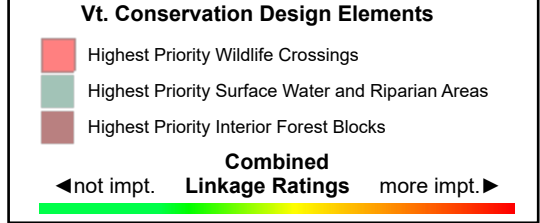
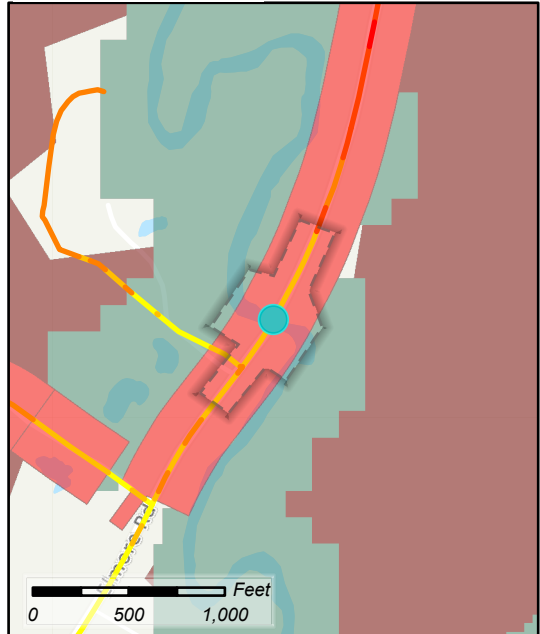
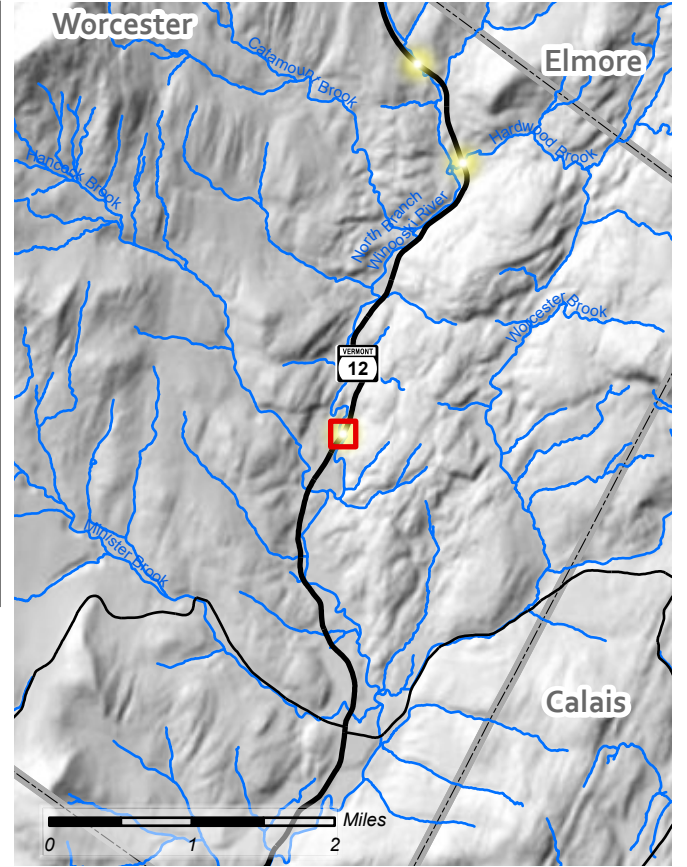

- Mile Markers (VCGI)
- ▭ Study Area
- ▭ Structures
- ▭ Wetlands
- Stream or Edge of Water
- - - Stream Top-of-Bank
- ▭ RTE Plant: S1
- ▭ Uncommon Plant: S3
- 🌳 Potential Bat Tree
- ▭ Deer Winter Areas (Vt F&W)

NOTES: INFORMATION PROVIDED BASED ON REMOTE AND FIELD ASSESSMENT BY ARROWWOOD ENVIRONMENTAL, 2019. WETLANDS FIELD DELINEATED, FLAGGED AND FLAGS LOCATED WITH SUB-METER GRADE GPS BY ARROWWOOD ENVIRONMENTAL. STREAMS, TOP-OF BANK, PLANT POPULATIONS, WILDLIFE FEATURES, AND STRUCTURE LOCATIONS FROM SUB-METER GRADE GPS, FIELDNOTES, AND ANALYSIS OF AERIAL IMAGERY AND HIGH-RESOLUTION LIDAR TOPOGRAPHIC DATA.

OTHER DATA FROM VCGI, VT AGENCY OF NATURAL RESOURCES. CONTOUR INTERVAL 1' DERIVED FROM LIDAR-BASED ELEVATION MODELS PROVIDED BY VCGI. MILE MARKERS FROM VCGI LAYER TITLED: "VT_MILE_POINTS_110MILE". BACKGROUND IMAGERY- VCGI 2018.



1: 10,757
August 21, 2019

546.0 0 273.00 546.0 Meters

WGS_1984_Web_Mercator_Auxiliary_Sphere 1" = 896 Ft. 1cm = 108 Meters

© Vermont Agency of Natural Resources THIS MAP IS NOT TO BE USED FOR NAVIGATION

DISCLAIMER: This map is for general reference only. Data layers that appear on this map may or may not be accurate, current, or otherwise reliable. ANR and the State of Vermont make no representations of any kind, including but not limited to, the warranties of merchantability, or fitness for a particular use, nor are any such warranties to be implied with respect to the data on this map.

NOTES

Map created using ANR's Natural Resources Atlas



LEGEND

- 303(d) List of Impaired Stream
 - Designated ORW (Streams and Lakes)
 - Prospective ORW (Streams and Lakes)
 - Prospective ORW (Lakes and Ponds)
 - Green Mountain National Forest
 - Act250 Permits **INCOMPLETE
- Roads
- Interstate
 - Principal Arterial
 - Minor Arterial
 - Major Collector
 - Minor Collector
 - Local
 - Not part of function Classification S
- Waterbody
 - Stream
 - Town Boundary

1: 5,379
August 21, 2019

NOTES

Map created using ANR's Natural Resources Atlas

273.0 0 136.00 273.0 Meters

WGS_1984_Web_Mercator_Auxiliary_Sphere 1" = 448 Ft. 1cm = 54 Meters

© Vermont Agency of Natural Resources THIS MAP IS NOT TO BE USED FOR NAVIGATION

DISCLAIMER: This map is for general reference only. Data layers that appear on this map may or may not be accurate, current, or otherwise reliable. ANR and the State of Vermont make no representations of any kind, including but not limited to, the warranties of merchantability, or fitness for a particular use, nor are any such warranties to be implied with respect to the data on this map.



LEGEND

Private Wells

- Incorrectly Located (Pink square)
- GPS Located (Green circle)
- Screen Digitized (Light green circle)
- E911 Address Matched (Grey circle)
- Welldriller/Clarion (Orange circle)
- Unknown Location Method (Red circle)

Public Water Sources

- Active (Blue circle)
- Proposed (Yellow circle)
- Inactive (Red circle)

Surface Water SPA

- Active (Yellow square)
- Inactive (Dashed yellow square)

Ground Water SPA

- Active (Purple square)
- Proposed (Dashed purple square)
- Inactive (Light purple square)

Roads

- Interstate (Red line)
- Principal Arterial (Orange line)
- Minor Arterial (Yellow line)
- Major Collector (Green line)
- Minor Collector (Grey line)
- Local (Light grey line)
- Not part of function Classification S (Thin grey line)

Waterbody

- Waterbody (Blue area)

1: 10,757
August 21, 2019

546.0 0 273.00 546.0 Meters

WGS_1984_Web_Mercator_Auxiliary_Sphere 1" = 896 Ft. 1cm = 108 Meters

© Vermont Agency of Natural Resources THIS MAP IS NOT TO BE USED FOR NAVIGATION

DISCLAIMER: This map is for general reference only. Data layers that appear on this map may or may not be accurate, current, or otherwise reliable. ANR and the State of Vermont make no representations of any kind, including but not limited to, the warranties of merchantability, or fitness for a particular use, nor are any such warranties to be implied with respect to the data on this map.

NOTES

Map created using ANR's Natural Resources Atlas

Appendix H: Archeological Memo

Jeannine Russell
VTrans Archaeology Officer
State of Vermont
Environmental Section
One National Life Drive
Montpelier, VT 05633-5001
802-477-3460 phone
Jeannine.russell@vermont.gov

Agency of Transportation

To: Jeff Ramsey, Environmental Specialist Supervisor

From: Jeannine Russell, VTrans Archaeology Officer via Timothy Quesnell, VTrans Archaeology Apprentice II

Date: October 28, 2019

Subject: Worcester BF 0241(59) – Archaeological Resource ID

VTrans proposes work on a bridge in the town of Worcester located on Vermont Route 12. The current scope and boundaries of the project are unknown. A circle with the bridge sitting at the center has been used for a stand in project area on the map provided. The VTrans Archaeology Apprentice were able to conduct a field visit on August 30th, 2019.

The project area is located about 2 miles north from the Worcester town center along Route 12. The north branch of the Winooski River runs eastward underneath the bridge and follows the route southward. Three small ponds sit at a higher elevation southeast of the bridge within 180 meters. A large wetland encircles two of these ponds, starting at 70 meters away from the bridge. The land present in the eastern quads of the project area look to be excessively steeping, while the western quads have a more gradual slope. The area around the house in the northeast quadrant appears disturbed. The rest of the project area appears to be undisturbed land.

Using the environmental predictive model, a score of 30 was found for this location, determined by the nearby wetlands within 70m, and the river flowing underneath the bridge. The score of the model indicates moderate sensitivity. Additionally, a saw mill was found present within the project area on the Beers and Wailings maps. The field visit taken by the archaeology apprentice found that the land immediately around the bridge was rocky and steep, making it unsuitable to the preservation of cultural resources reducing the overall score to 6 deeming it not culturally sensitive. To the west of this rocky area is a small river flood plain on the south side of the Winooski. No surface structures indicating the old mill were identified but given the preservation conditions of the flood plain the space has been marked as sensitive for historic archaeological resources on the map below.

Most of the project area is steep and rocky, leaving few areas for preservation. However, the space near the river surface may have the foundations of the old saw mill below the soil surface. For this reason, the flood plain should be avoided. If staging is required for this project, previously disturbed land or paved road would be recommended for use. A map of the area outlining archaeologically sensitive areas in red has been provided below, in addition to other relevant figures.

Please let me know if you have any questions.

Thank you,
Jen Russell
VTrans Archaeology Officer

Figure 1: Project Location

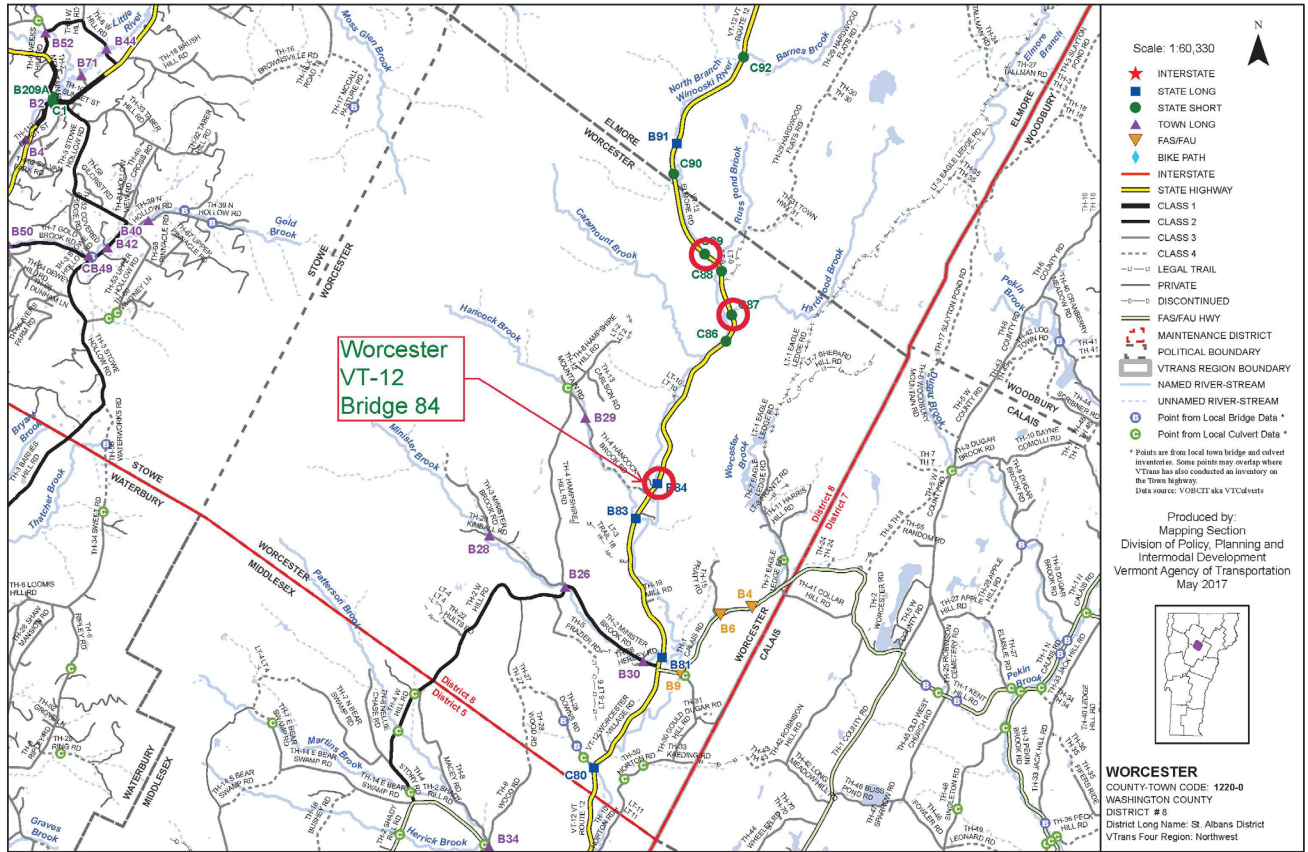

This map was funded in part through grants from the Federal Highway Administration, U.S. Department of Transportation. The representation of the authors expressed herein do not necessarily state or reflect those of the U. S. Department of Transportation.

Figure 2: ARA Map



Figure 3: Photo of the road facing north



Figure 4: Photo of the road facing south



Figure 5: Excerpt from Beers map of the region showing location of saw mill



Appendix I: Historic Memo

State of Vermont

Agency of Transportation

Gabrielle Fernandez
AOT Technical Apprentice IV
Gabrielle.Fernandez@vermont.gov
(802) 793-3738

Project Delivery Bureau - Environmental Section
One National Life Drive
Montpelier, VT 05633-5001
vtrans.vermont.gov

Historic Resources Identification Memo

To: Jeff Ramsey, AOT Environmental Specialist
CC: Jeannine Russell, AOT Archaeology Officer
Reviewed By: Judith Ehrlich, AOT Historic Preservation Officer

Date: November 1, 2019

Subject: Worcester BHF 0241(59) 86E053

I have completed the Resource Identification for Worcester BHF 0241(59). There are no historic resources identified within the survey area. In addition, there are no other 4(f) resources were identified within the survey area.

This Resource Identification effort is being undertaken to provide information to the VTrans designers working on a proposed improvement project on bridge number 84 in Worcester (Figure 1). Toward that end, VTrans Cultural Resources staff have identified potential resources within a broad preliminary Area of Potential Effect to ensure the designers are aware of all cultural resources that could possibly be affected by a project. Once the project is defined at the Conceptual Design phase, Cultural Resources staff will be able to determine a formal Area of Potential Effect for purposes of Section 106, 22 VSA § 14, and Section 4(f) responsibilities.

Bridge number 84 is a single span rolled steel beam bridge over the North Branch of the Winooski River on VT 12 (Figures 2 and 3). Built in 1936, this structure is approximately 84 feet long and features a concrete deck and abutments. This bridge allows for passage over a steep and rocky ravine, as well as a marshland.

According to the *Metal Truss, Masonry and Concrete Bridges of Vermont, 1820-1978* Multiple Property Documentation Form, this bridge would have been one of the earlier bridges as part of the newly created State Highway Commission. Likely, the original bridge was taken over by the state in 1934 as part of a push to integrate “through roads” with the state system. As a result of this push, many bridges were repaired or replaced between 1934-1936. However, this bridge was not one of the 17 bridges that were given special Progress Works Administration funds between 1936-1938. The bridge type itself is not unique. According to the National Cooperative Highway Research Program’s *A Context for Common Historic Bridge Types*, rolled beam highway bridges became popular in the 1920s, with reinforced concrete decks standard by the 1930s. This standard bridge design would become popular as part of a push in Vermont and other states for the standardization of bridge design.

Metal rolled beam bridges possess lower significance within the context of bridge studies. The key character-defining features for significance include its beams, construction techniques, age, and any original rails, piers, wingwalls, or abutments. To be considered historic, early simple span steel beam bridges must be either significant in length or welded to be considered historic. Bridge No. 50 is a rolled steel bridge so is not considered historic.

A second resource was identified roughly 25 feet east of the current bridge at this crossing (Figure 4). Using the bridge as a vantage point, one can easily see the dry laid stone abutments of an earlier crossing or structure right next to the property at 597 Vt-12. This remnant of a previous bridge stone structure is not considered historic or eligible for listing on the National Register.

A third property was identified at 597 VT-12 in Worcester (Figure 5). This 1 ½ story gable roofed structure meets the 50-year age criteria for the National Register. However, changes to the building over time have sufficiently altered the character defining features of the property that this building no longer retains enough integrity to be eligible for the National Register.

Two other structures were located within the survey area. They are:

1. A single-story ranch on Moose Hollow Road that is ineligible due to age (Figure 6).
2. A 1 ½ story home at 599 VT-12 that is ineligible due to alterations and a loss of integrity (Figure 7).

No other buildings, structures, or sites were located within the survey area.

Please do not hesitate to contact me should you have any questions.

Attachments:

- Map
- Photos



Figure 1: Google Earth view of the approximate survey area for Worcester BHF 0241(59).



Figure 2: Bridge number 84 in Worcester.



Figure 3: Note the bridges original Art Deco detailing and poor substructure.



Figure 4: Early dry laid abutments from a previous structure are viewable in the rightmost portion of this image. This is also visible in Figure 2.



Figure 5: Historic resource at 597 VT-12 that is no longer eligible for the National Register. Door and windows have been replaced and the shed roof additions on either side obscure the original building configuration.



Figure 6: Ineligible resource on Moose Hollow Rd.



Figure 7: Ineligible resource at 599 VT-12.



Figure 8: Looking north on VT-12 towards bridge number 84 in Worcester.

Appendix J: Hazardous Sites Map



LEGEND

- Landfills**
 - OPERATING
 - CLOSED
- Land Use Restrictions**
 - Class IV GW Reclass
 - Class VI GW Reclass
 - Deed Restriction
 - Easement
 - Land Record Notice
 - Other
- Hazardous Site
- Hazardous Waste Generators
- Brownfields
- Salvage Yard
- Aboveground Storage Tank
- Underground Storage Tank (w/)
- Dry Cleaner
- Urban Soil Background Areas
- Roads**
 - Interstate
 - Principal Arterial
 - Minor Arterial
 - Major Collector
 - Minor Collector
 - Local
 - Not part of function Classification S
- Waterbody

1: 10,757
August 21, 2019

546.0 0 273.00 546.0 Meters

WGS_1984_Web_Mercator_Auxiliary_Sphere 1" = 896 Ft. 1cm = 108 Meters
© Vermont Agency of Natural Resources THIS MAP IS NOT TO BE USED FOR NAVIGATION

DISCLAIMER: This map is for general reference only. Data layers that appear on this map may or may not be accurate, current, or otherwise reliable. ANR and the State of Vermont make no representations of any kind, including but not limited to, the warranties of merchantability, or fitness for a particular use, nor are any such warranties to be implied with respect to the data on this map.

NOTES

Map created using ANR's Natural Resources Atlas

Appendix K: Community Input

Local & Regional Input Questionnaire

Project Summary

This project, BHF 0241(59), focuses on bridge 84 on VT Route 12 in Worcester, Vermont. The bridge is deteriorating and is in need of either a major maintenance action or replacement. Potential options being considered for this project include a deck replacement, superstructure and deck replacement, and a bridge replacement on the existing alignment. It is possible that VTTrans will recommend a road closure and detour traffic away from the project site for the duration of the work. Efforts will be made to limit the detour to State roads.

Community Considerations

1. Are there regularly scheduled public events in the community that will generate increased traffic (e.g. vehicular, bicycles and/or pedestrians), or may be difficult to stage if the culvert is closed during construction? Examples include annual bike races, festivals, parades, cultural events, weekly farmers market, concerts, etc. that could be impacted? If yes, please provide approximate date, location and event organizers' contact info.

4th of July. Thursday, June thru September- Farmer's Market.

2. Is there a "slow season" or period of time from May through October where traffic is less or no events are scheduled?

May-August

3. Please describe the location of the Town garage, emergency responders (fire, police, ambulance) and emergency response routes that might be affected by the closure of the culvert, one-way traffic, or lane closures and provide contact information (names, address, email addresses, and phone numbers).

Brian Powers, brianpowers68@comcast.net 223-6942 11 Maxham Dr. is the highway dept: Will Sutton, wsznbvt@comcast.net 802-557-1037 20 Worcester Village Rd is the location of the fire dept.; Rt 12 is the only access for fire and rescue to reach homes north on Rt12. Highway is responsible to plow side roads only accessible from Rt12.

4. Are there businesses (including agricultural operations and industrial parks) or delivery services (fuel or goods) that would be adversely impacted either by a detour or due to work zone proximity?

Yes, Rt12 is the only access to many homes.

5. Are there important public buildings (town hall, community center, senior center, library) or community facilities (recreational fields, town green, etc.) close to the project?

No

6. What other municipal operations could be adversely affected by a road/culvert closure or detour?

Schools

7. Are there any town highways that might be adversely impacted by traffic bypassing the construction on other local roads? Please indicate which roads may be affected and their

Local & Regional Input Questionnaire

condition (paved/unpaved, narrow, weight-limited culverts, etc), including those that may be or go into other towns.

Calais Rd-paved/gravel

8. Is there a local business association, chamber of commerce, regional development corporation, or other downtown group that we should be working with? If known, please provide name, organization, email, and phone number.

No

9. Are there any public transit services or stops that use the culvert or transit routes in the vicinity that may be affected if they become the detour route?

No

Schools

1. Where are the schools in your community and what are their yearly schedules (example: first week in September to third week in June)?

South of Bridge on Calais Rd – August thru June

2. Is this project on specific routes that school buses or students use to walk to and from school?

Yes

3. Are there recreational facilities associated with the schools nearby (other than at the school)?

Yes-Ladd Field

Pedestrians and Bicyclists

1. What is the current level of bicycle and pedestrian use on the culvert?

Heavy Bicycle/pedestrian

2. Are the current lane and shoulder widths adequate for pedestrian and bicycle use?

No

3. Does the community feel there is a need for a sidewalk or bike lane on the culvert?

Yes

4. Is pedestrian and bicycle traffic heavy enough that it should be accommodated during construction?

Yes

5. Does the Town have plans to construct either pedestrian or bicycle facilities leading up to the culvert? Please provide any planning documents demonstrating this (scoping study, master plan, corridor study, town or regional plan).

No

Local & Regional Input Questionnaire

6. In the vicinity of the culvert, is there a land use pattern, existing generators of pedestrian and/or bicycle traffic, or zoning that will support development that is likely to lead to significant levels of walking and bicycling?

No

Design Considerations

1. Are there any concerns with the alignment of the existing road? For example, if the culvert is located on a curve, has this created any problems that we should be aware of?

Width is a problem

2. Are there any concerns with the width of the road over the existing culvert?

Yes-too narrow

3. Are there any special aesthetic considerations we should be aware of?

No

4. Does the location have a history of flooding? If yes, please explain.

No

5. Are there any known Hazardous Material Sites near the project site?

No

6. Are there any known historic, archeological and/or other environmental resource issues near the project site?

Unknown

7. Are there any utilities (water, sewer, communications, power) buried with the existing culvert? Please provide any available documentation.

Unknown

8. Are there any existing, pending, or planned municipal utility projects (communications, lighting, drainage, water, wastewater, etc.) near the project that should be considered?

No

9. Are there any other issues that are important for us to understand and consider?

Houses close to bridge

Land Use & Zoning

1. Please provide a copy of your existing and future land use map or zoning map, if applicable.

N/A

Local & Regional Input Questionnaire

2. Are there any existing, pending or planned development proposal that would impact future transportation patterns near the culvert? If so, please explain.

Unknown

3. Is there any planned expansion of public transit or intercity transit service in the project area? Please provide the name and contact information for the relevant public transit provider.

No

Communications

1. Please identify any local communication outlets that are available for us to use in communicating with the local population. Include weekly or daily newspapers, blogs, radio, public access TV, Facebook, Front Page Forum, etc. Also include any unconventional means such as local low-power FM.

FPF, Times Argus, Washington World, Town website, Facebook, WDVE, WGER

2. Other than people/organizations already referenced in this questionnaire, are there any others who should be kept in the loop as the project moves forward?**Unknown**

Appendix L: Operations Input

Bridge Scoping Project BHF 0241(59) Operations Input Questionnaire

The Structures Section has begun the scoping process for BHF 0241(59), VT Route 12, Bridge 84, over the North Branch in Worcester. This is a rolled beam/concrete deck bridge constructed in 1936. The Structure Inspection, Inventory, and Appraisal Sheet (attached) rates the deck as 4 (poor), the superstructure as 6 (satisfactory), and the substructures as 6 (satisfactory). We are interested in hearing your thoughts regarding the items listed below. Leave it blank if you don't wish to comment on a particular item.

1. What are your thoughts on the general condition of this bridge and the general maintenance effort required to keep it in service?

General condition is very poor, constant patching of road surface is needed concrete side are crumbling.

2. What are your comments on the current geometry and alignment of the bridge (curve, sag, banking, sight distance)?

Bridge sits in lowest part of the dip in the roadway and gathers and holds water. Bridge should be moved west to better align with the road removing several corners and improve a driveway at the north end

3. Do you feel that the posted speed limit is appropriate?

yes

4. Is the current bridge and approach roadway width adequate for winter maintenance including snow plowing?

No with just the plow down there isn't safe space to meet a car. Due to the sloping of the road the bridge gathers and holds water and the solid sides hinder the removal of snow all resulting in increased salt usage

5. Are the joints salvageable or would you recommend replacement?

I would recommend replacement

6. Are the railings constantly in need of repair or replacement? What type of railing works best for your district? (We are recommending more and more box beam guardrail on our bridges because of crash-worthiness and compatibility with accelerated projects).

No but are in poor condition I would recommend full replacement with box beam for a couple reasons one the current design hinders snow removal due to snow not being able to pass thru the railing, and two the terrain surrounding the bridge is very steep and rocky making it very difficult to properly deploy a proper working over water plan if the railing was raised to proper railing height would reduce the frequency of needing a wow plan.

7. Are you aware of any unpermitted driveways within close proximity to the bridge? We frequently encounter driveways that prevent us from meeting railing and safety standards.

There is a driveway right at the north end not sure of permit status, but it is an older drive that may have been built before permits were in place.

Bridge Scoping Project BHF 0241(59) Operations Input Questionnaire

8. Are you aware of abutting property owners that are likely to need special attention during the planning and construction phases? These could be people with disabilities, elderly, or simply folks who feel they have been unfairly treated in the past.

We have received complaints from the house right at the north east end of the bridge due to their driveway being the area the water from the roadway is most likely to drain causing flooding of their lawn area

9. Do you find that extra effort is required to keep the slopes and river banks around the bridge in a stable condition? Is there frequent flood damage that requires repair?

Some washing on the south west end but historically been mostly stable due to the amount of ledge in the area

10. Does this bridge seem to catch an unusual amount of debris from the waterway?

No but does have beaver activity in close proximity

11. Are you familiar with traffic volumes in the area of this project?

Low

12. Do you think a closure with off-site detour and accelerated construction would be appropriate?

Do you have any opinion about a possible detour route, assuming that we use State route for State projects and any route for Town projects? Are there locations on a potential detour that are already congested that we should consider avoiding?

Yes, for full replacement with accelerated construction keeping in mind that the detour would be lengthy and would have to start in Morrisville and Montpelier if just widening I think there's room on the west side to work while maintain one way traffic

13. Please describe any larger projects that you have completed that may not be reflected on the attached Appraisal sheet, such as deck patches, paving patches, railing replacement with new type, steel coating, etc.

Deck has been patched and joints worked on within the last 5 years

14. Are there any drainage issues that we should address on this project?

Yes, all the roadway water runs to the north end of the bridge and ponds eventually draining down a neighbor's driveway

15. Are you aware of any complaints that the public has about issues that we can address on this project?

Yes, the drainage issues on north end and the width of the bridge

16. Is there anything else we should be aware of?

Due to the low volume of traffic and the road running thru a largely undeveloped area it's a popular road for bicycles and this bridge is a very dangerous area for them to mix with traffic due to width. Beavers are present in area

Appendix M: Crash Data

General Yearly Summaries - Crash Listing: State Highways and All Federal Aid Highway Systems

WHERE Year of Crash >= 2012 AND Year of Crash <= 2016

* Reporting Agency/ Incident No.	City/Town	Mile Marker	Crash Date	Time	Weather	Contributing Circumstances	Direction of Collision	Number Of Injuries	Number Of Fatalities	Number Of Untimely Deaths	Direction	Road Group
VTVSP1200/13A303188	Worcester	2.39	08/04/2013	12:43	Clear	Failed to yield right of way, No improper driving	Left Turn and Thru, Angle Broadside -->v--	1	0	0	N, S	SH Owned
VTVSP1200/16A304476	Worcester	2.68	10/18/2016	10:20	Clear	Driving too fast for conditions	Single Vehicle Crash	1	0	0	S	SH State Owned
VTVSP1200/15A305585	Worcester	2.87	11/19/2015	14:17	Rain	Fatigued, asleep, Failure to keep in proper lane	Single Vehicle Crash	0	0	0	S	SH
VTVSP1200/15A301256	Worcester	2.99	03/15/2015	11:45	[No Weather]		[No Direction of Collision]	0	0	0		SH
VTVSP1200/13A304653	Worcester	3.16	11/05/2013	07:19	Cloudy	Failure to keep in proper lane, Inattention	Single Vehicle Crash	0	0	0	S	SH
VTVSP1200/15A305109	Worcester	3.87	10/18/2015	20:07	[No Weather]		[No Direction of Collision]	0	0	0		SH
VTVSP1200/16A305468	Worcester	6.20	12/16/2016	06:30	Clear	Driving too fast for conditions, Under the influence of medication/drugs/alcohol, No improper driving	Head On	2	0	0	S, N	SH State Owned
VTVSP1200/16A305156	Worcester	6.23	11/29/2016	07:36	[No Weather]		[No Direction of Collision]	0	0	0		SH State Owned
VTVSP1200/12A302163	Worcester	6.73	05/25/2012	18:00	Clear	Failure to keep in proper lane	Single Vehicle Crash	1	0	0	N	SH
VTVSP1200/12A301994	Worcester	UNK	05/14/2012	07:25	Rain	Other improper action	Rear End	2	0	0	N	SH
VTVSP1200/13A300873	Worcester	UNK	02/27/2013	21:00	[No Weather]		[No Direction of Collision]	0	0	0		SH
VTVSP1200/13A301934	Worcester	UNK	05/16/2013	20:50	Cloudy	No improper driving	Single Vehicle Crash	2	0	0	S	SH
VTVSP1200/14A301410	Worcester	UNK	03/30/2014	01:00	Sleet, Hail (Freezing Rain or Drizzle)	Fatigued, asleep, Failure to keep in proper lane	Single Vehicle Crash	1	0	0	N	SH
VTVSP0100/16A101604	Elmore	1.79	04/02/2016	21:51	Cloudy	Under the influence of medication/drugs/alcohol, Exceeded authorized speed limit	Single Vehicle Crash	1	0	0	S	SH State Owned
VTVSP0100/12A103503	Elmore	3.52	09/08/2012	19:12	Rain	Under the influence of medication/drugs/alcohol	Single Vehicle Crash	1	0	0	N	SH
VTVSP0100/14A105918	Elmore	4.65	12/26/2014	14:38	Clear	Swerving or avoiding due to wind, slippery surface, vehicle, object, non-motorist in roadway etc, No improper driving	Same Direction Sideswipe	0	0	0	N	SH
VTVSP0100/15A100413	Elmore	4.66	01/25/2015	07:06	[No Weather]		[No Direction of Collision]	0	0	0		SH
VTVSP0100/16A106536	Elmore	4.66	12/22/2016	21:50	[No Weather]		[No Direction of Collision]	0	0	0		SH State Owned
VTVSP0100/16A103497	Elmore	4.90	07/14/2016	13:26	[No Weather]		[No Direction of Collision]	0	0	0		SH State Owned
VTVSP0100/16A106388	Elmore	4.96	12/15/2016	17:39	[No Weather]		[No Direction of Collision]	0	0	0		SH State Owned
VTVSP0100/15A100804	Elmore	5.07	02/11/2015	10:27	[No Weather]		[No Direction of Collision]	0	0	0		SH
VTVSP0100/15A105765	Elmore	5.11	11/10/2015	17:40	Cloudy	No improper driving	Single Vehicle Crash	0	0	0	N	SH

*Crash occurred prior to the last Highway Improvement Project. This data should not be used in a crash analysis. UNK indicates Mile Marker is Unknown.

Appendix N: Utility Resource Identification

From Utilities:

Laura,

I have completed the investigation on the subject project and have the following to offer:

Aerial: Green Mountain Power has a single phase line crossing over the eastern edge of the culvert. Consolidated leaves the highway right of way just south of the culvert.

Underground: There are no underground facilities at this location along VT12.

Shaun Corbett | Utility Coordination Supervisor

Vermont Agency of Transportation

One National Life Drive | Montpelier, VT 05633-5001

802-371-7943 cell

shaun.corbett@vermont.gov

Appendix O: Detour Routes

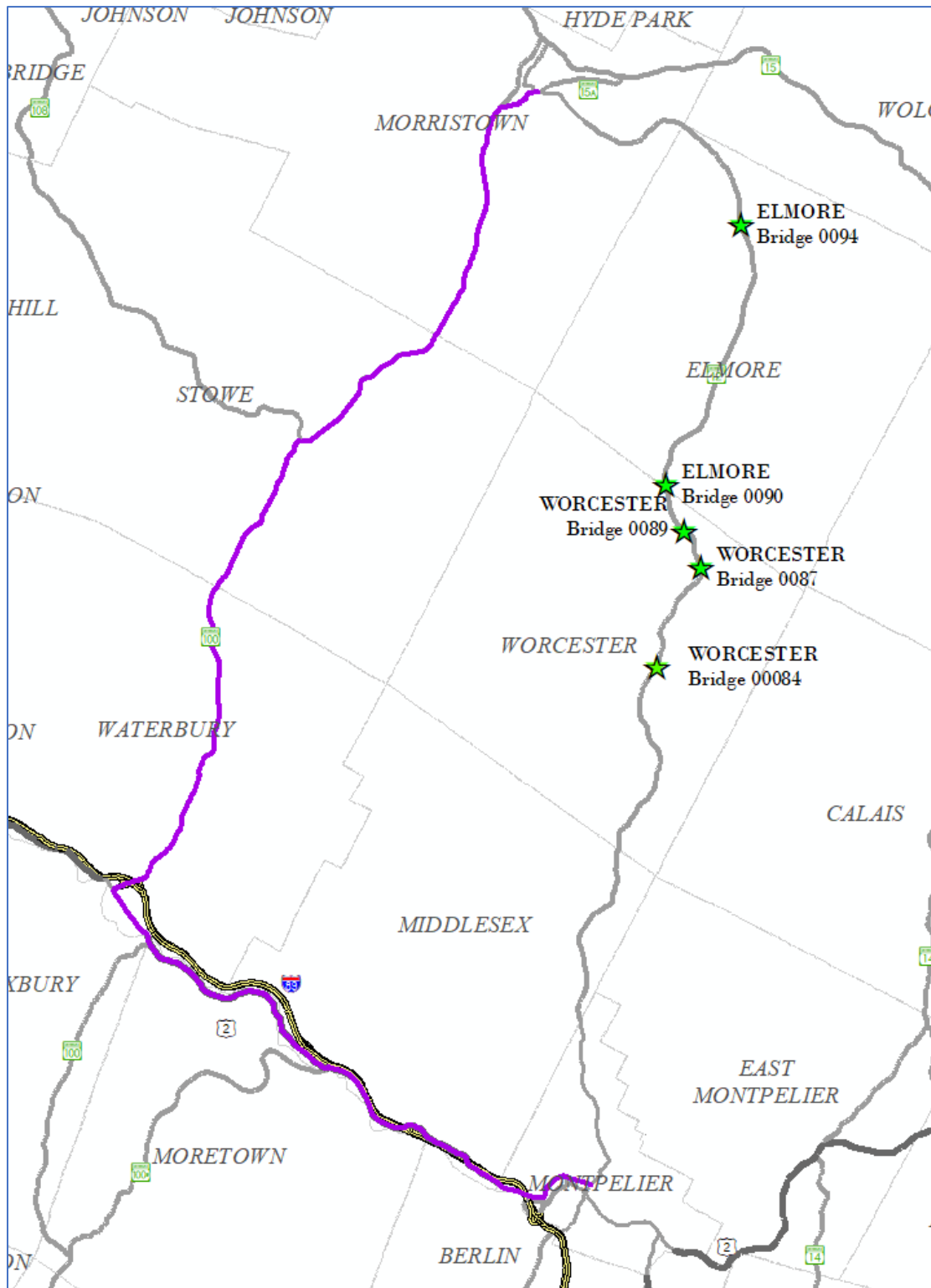

Regional Detour Route 1: VT Route 12, to VT Route 100, and US Route 2, back to VT Route 12

Through Route: 26.2 miles
 Detour Route: 30.9 miles
 Added Distance: 4.7 miles
 End-to-End Distance: 57.1 miles

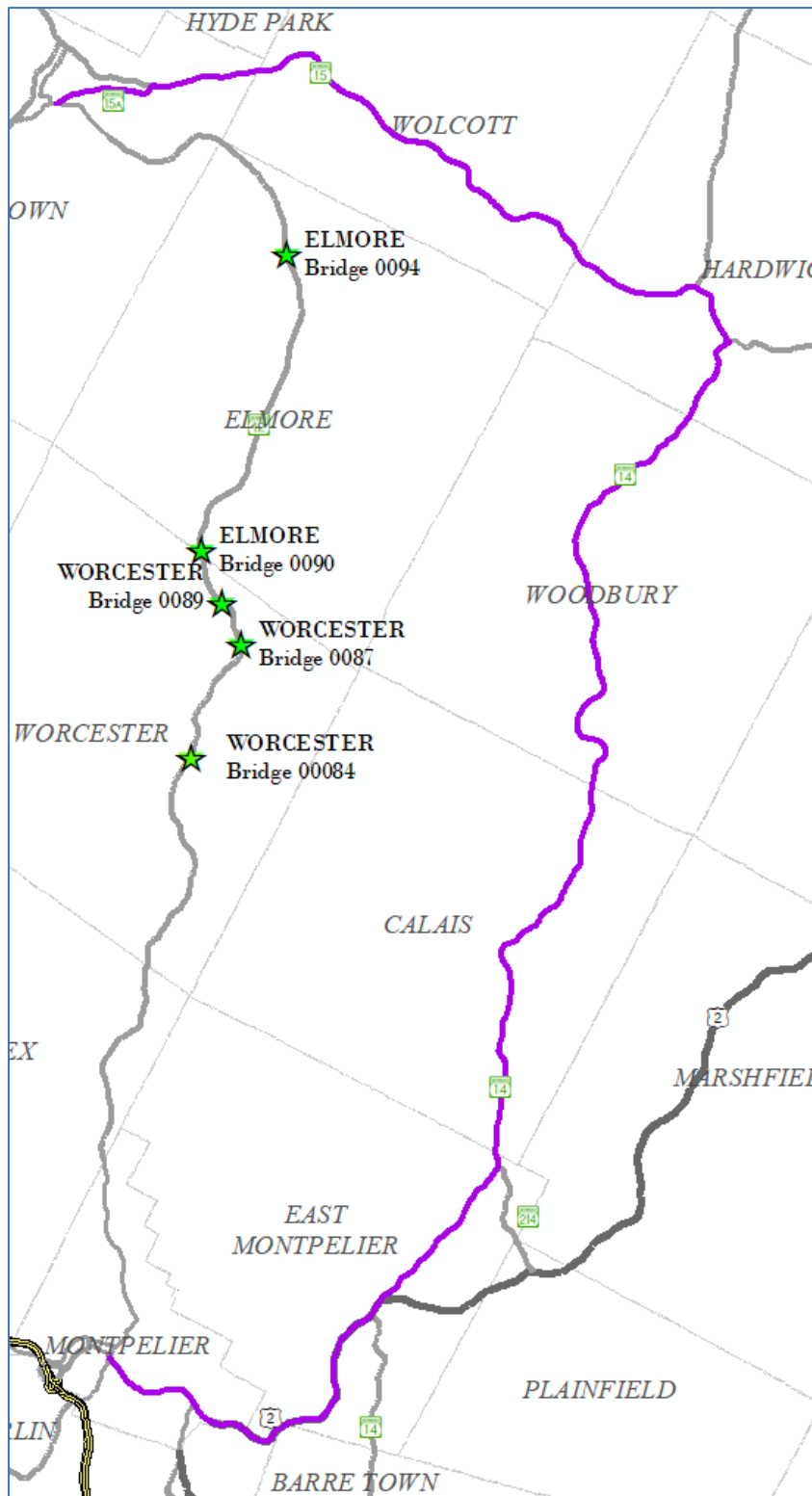

Regional Detour Route 2: VT Route 12, to US Route 2, VT Route 14, and VT Route 15, back to VT Route 12

Through Route: 26.4 miles
 Detour Route: 40.0 miles
 Added Distance: 13.6 miles
 End-to-End Distance: 66.4 miles

Appendix P: Plans

INDEX OF SHEETS

SHEET NO.	SHEET DESCRIPTION
1	Existing Conditions Layout Sheet
2	Existing Conditions Profile
3	Existing Typical Section
4	Minor Rehabilitation Typical Section
5	Minor Rehabilitation Layout
6	Deck Replacement Typical Section
7	Deck Replacement Layout
8	Superstructure Replacement Typical Section
9	Superstructure Replacement Layout
10	Full Bridge Replacement Typical Section
11	Full Bridge Replacement Layout
12	Upstream Temporary Bridge Layout
13	Downstream Temporary Bridge Layout
14	Phasing Typical Sections
15-16	Phasing Layouts

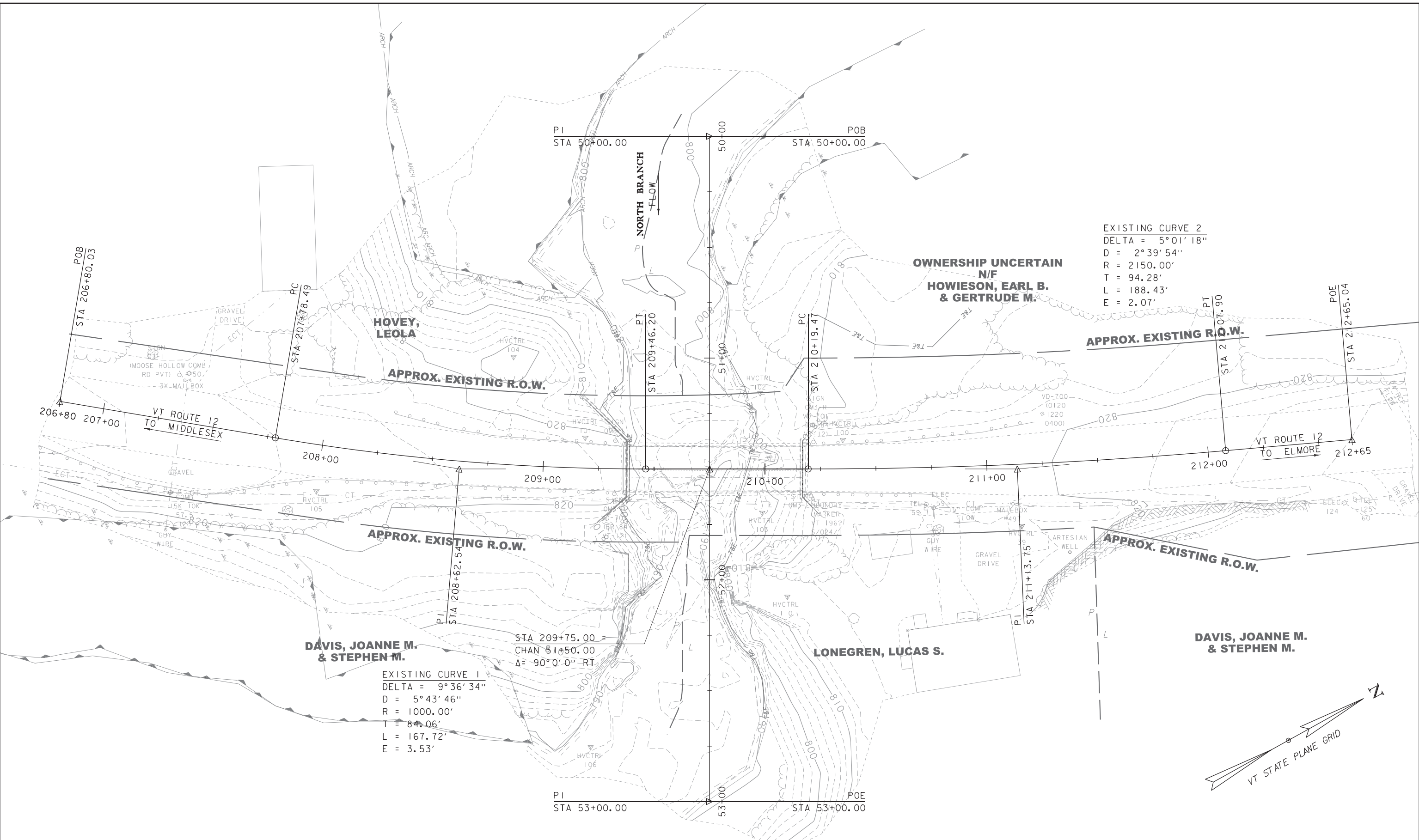

EXISTING BRIDGE INFORMATION
 BUILT 1936
 84' ROLLED BEAM
 CAST IN PLACE CONCRETE DECK

EXISTING CONDITIONS

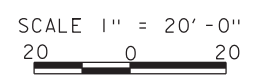

PROJECT NAME:	WORCESTER	PLOT DATE:	29-APR-2020
PROJECT NUMBER:	BHF 024(59)	DRAWN BY:	D.D.BEARD
FILE NAME:	86e053/s86e053border.dgn	CHECKED BY:	-----
PROJECT LEADER:	L.J.STONE	EXISTING CONDITIONS LAYOUT SHEET	SHEET 1 OF 16

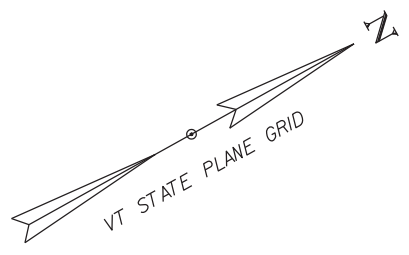

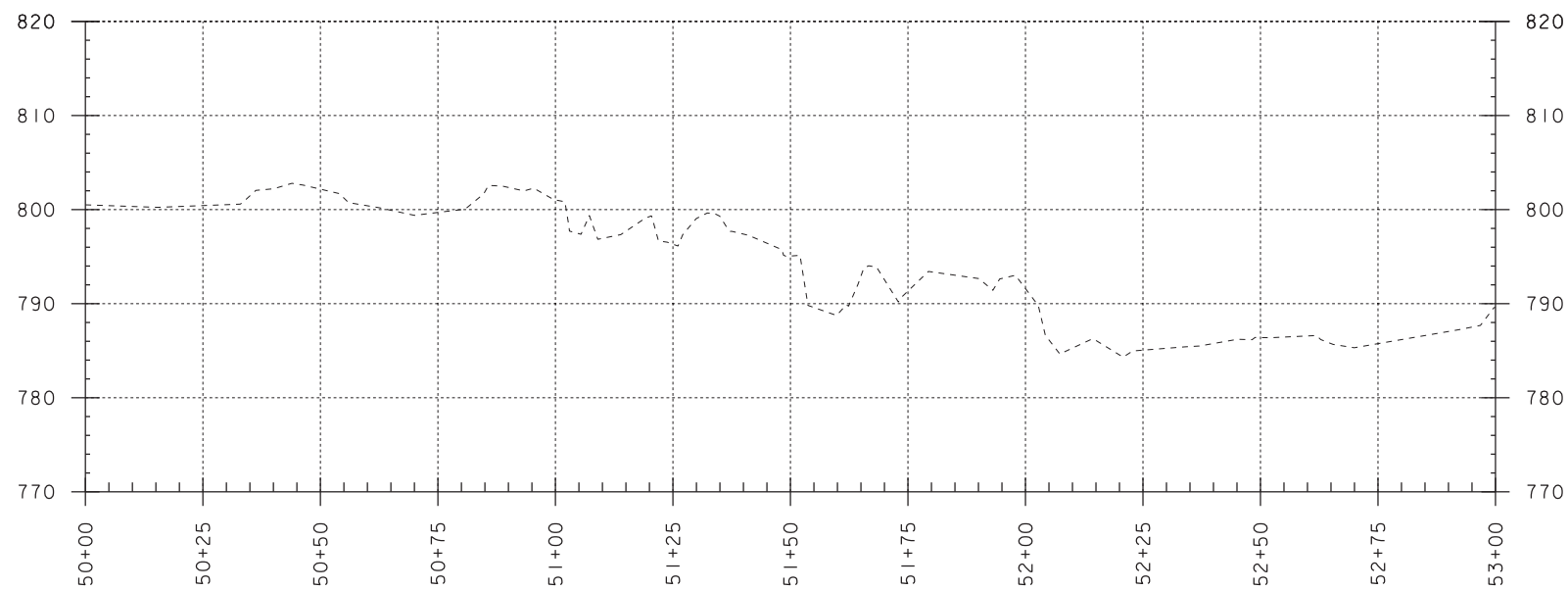
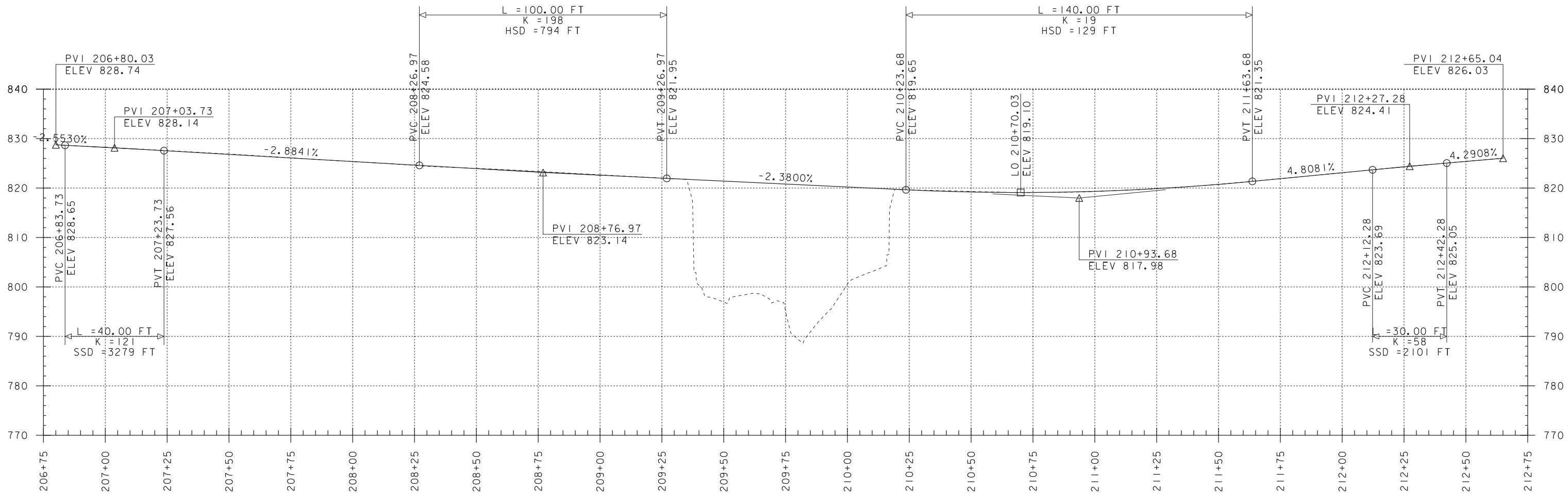

NOTE:
GRADES SHOWN TO THE NEAREST TENTH ARE EXISTING GROUND ALONG CL
GRADES SHOWN TO THE NEAREST HUNDREDTH ARE FINISH GRADE ALONG CL

PROJECT NAME:	WORCESTER	FILE NAME:	86e053/s86e053profile.dgn	PLOT DATE:	29-APR-2020
PROJECT NUMBER:	BHF 024(59)	PROJECT LEADER:	L.J.STONE	DRAWN BY:	D.D.BEARD
		DESIGNED BY:	-----	CHECKED BY:	-----
		PROFILE SHEET		SHEET	2 OF 16

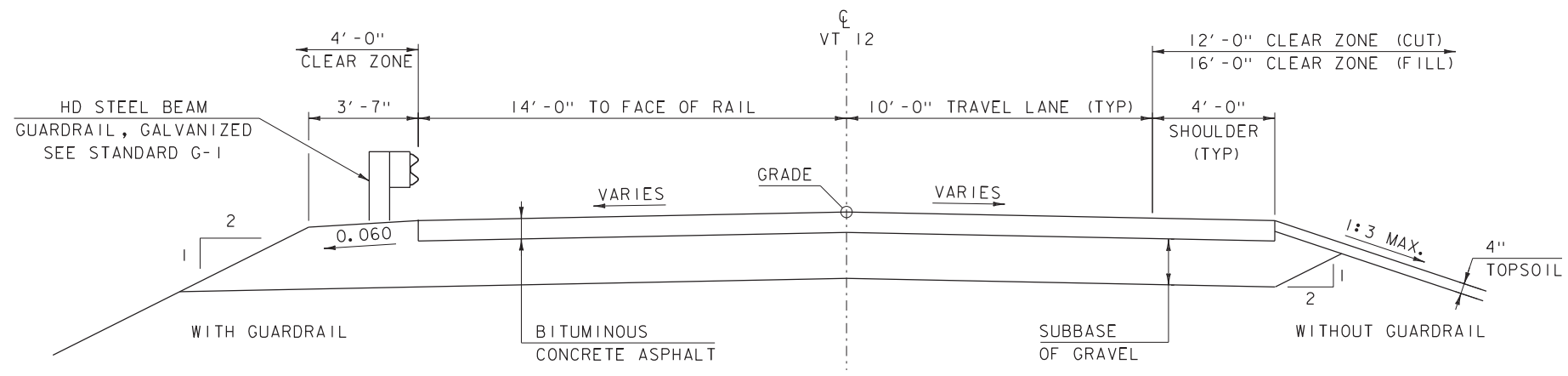

PROPOSED VT ROUTE 12 TYPICAL SECTION

SCALE 3/8" = 1'-0"

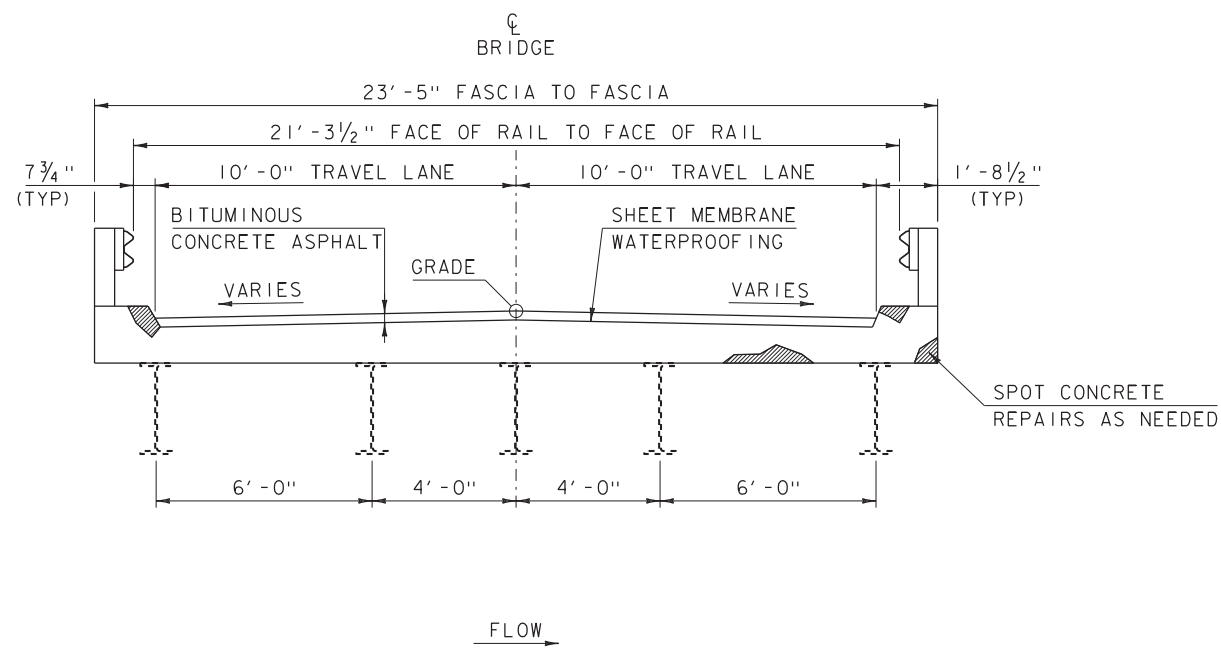

REHABILITATION TYPICAL SECTION

SCALE 3/8" = 1'-0"

MATERIAL TOLERANCES
(IF USED ON PROJECT)

SURFACE	
- PAVEMENT (TOTAL THICKNESS)	+/- 1/4"
- AGGREGATE SURFACE COURSE	+/- 1/2"
SUBBASE	+/- 1"
SAND BORROW	+/- 1"

PROJECT NAME: WORCESTER
PROJECT NUMBER: BHF 024(59)

FILE NAME: 86e053\s86e053\typical.dgn PLOT DATE: 29-APR-2020
PROJECT LEADER: L.J.STONE DRAWN BY: D.D.BEARD
DESIGNED BY: ----- CHECKED BY: -----
REHABILITATION TYPICAL SECTIONS SHEET 3 OF 16

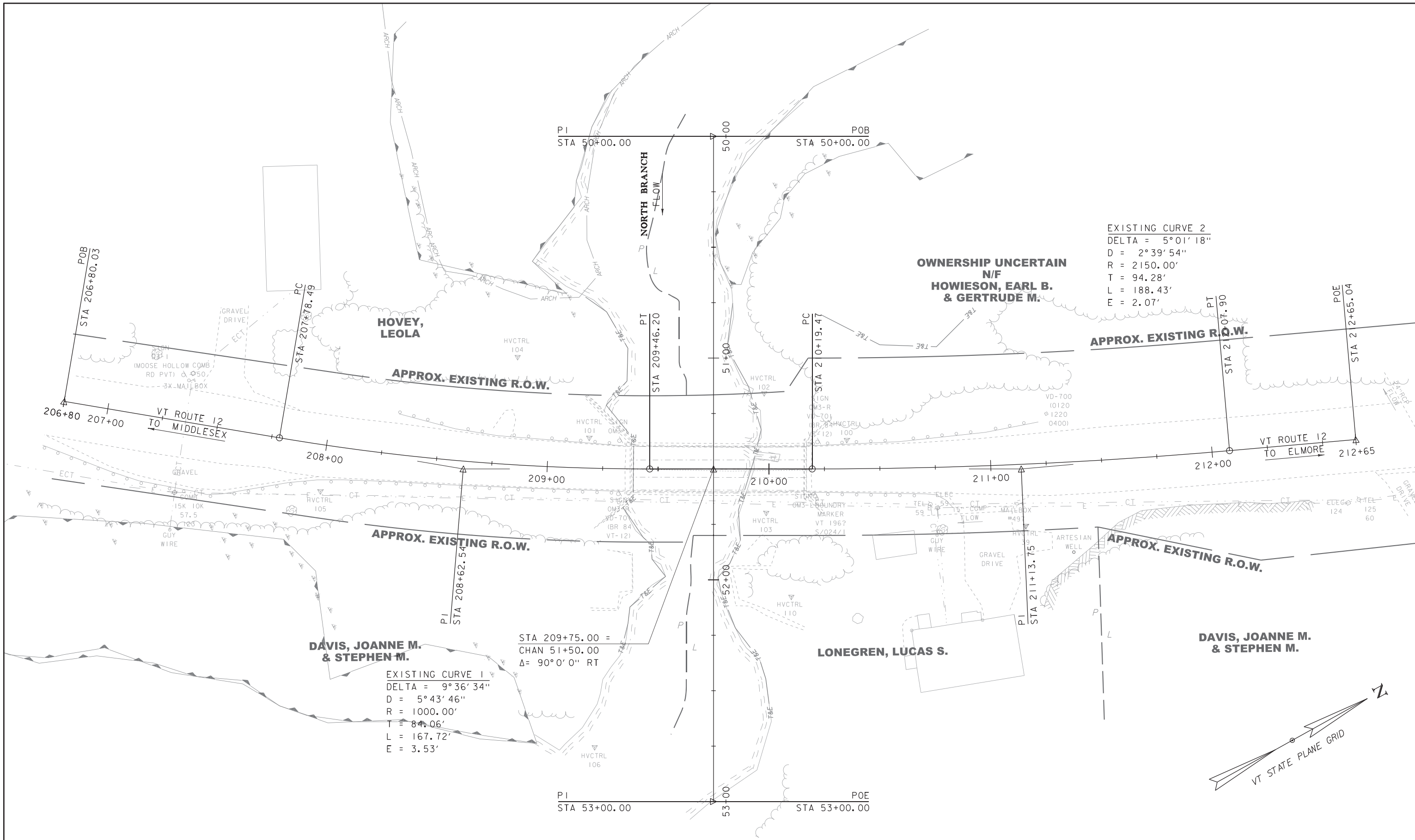

EXISTING BRIDGE INFORMATION
 BUILT 1936
 84' ROLLED BEAM
 CAST IN PLACE CONCRETE DECK

REHABILITATION LAYOUT

SCALE 1" = 20'-0"
 20 0 20

PROJECT NAME:	WORCESTER	PLOT DATE:	29-APR-2020
PROJECT NUMBER:	BHF 024(59)	DRAWN BY:	D.D.BEARD
FILE NAME:	86e053/s86e053border.dgn	CHECKED BY:	-----
PROJECT LEADER:	L.J.STONE	REHABILITATION LAYOUT SHEET	SHEET 4 OF 16

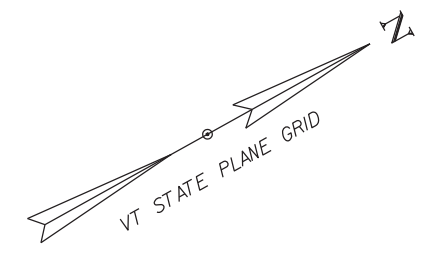

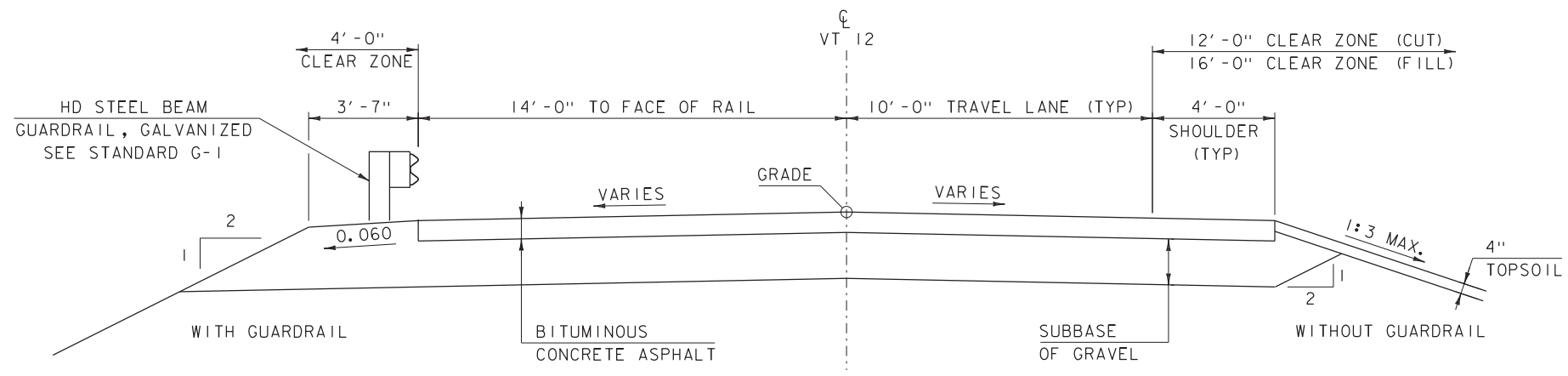

PROPOSED VT ROUTE 12 TYPICAL SECTION

SCALE 3/8" = 1'-0"

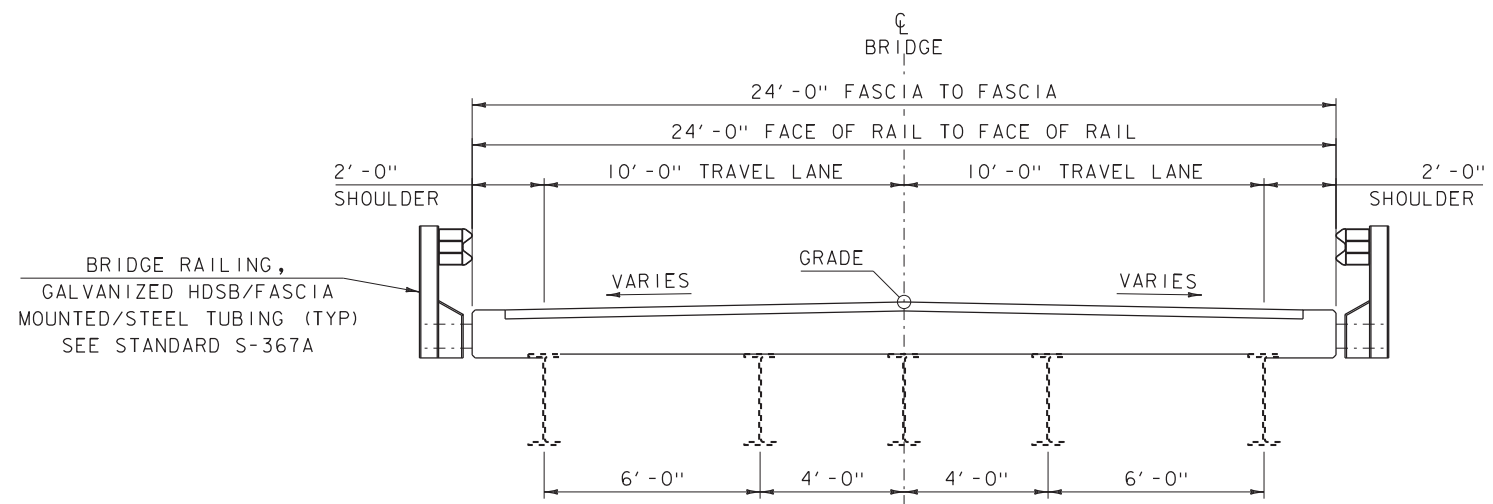

DECK REPLACEMENT TYPICAL SECTION

SCALE 3/8" = 1'-0"

MATERIAL TOLERANCES
(IF USED ON PROJECT)

SURFACE	
- PAVEMENT (TOTAL THICKNESS)	+/- 1/4"
- AGGREGATE SURFACE COURSE	+/- 1/2"
SUBBASE	
	+/- 1"
SAND BORROW	
	+/- 1"

PROJECT NAME: WORCESTER
PROJECT NUMBER: BHF 024(59)

FILE NAME: 86e053\s86e053\typical.dgn PLOT DATE: 29-APR-2020
PROJECT LEADER: L.J.STONE DRAWN BY: D.D.BEARD
DESIGNED BY: ----- CHECKED BY: -----
DECK REPLACEMENT TYPICAL SECTIONS SHEET 5 OF 16

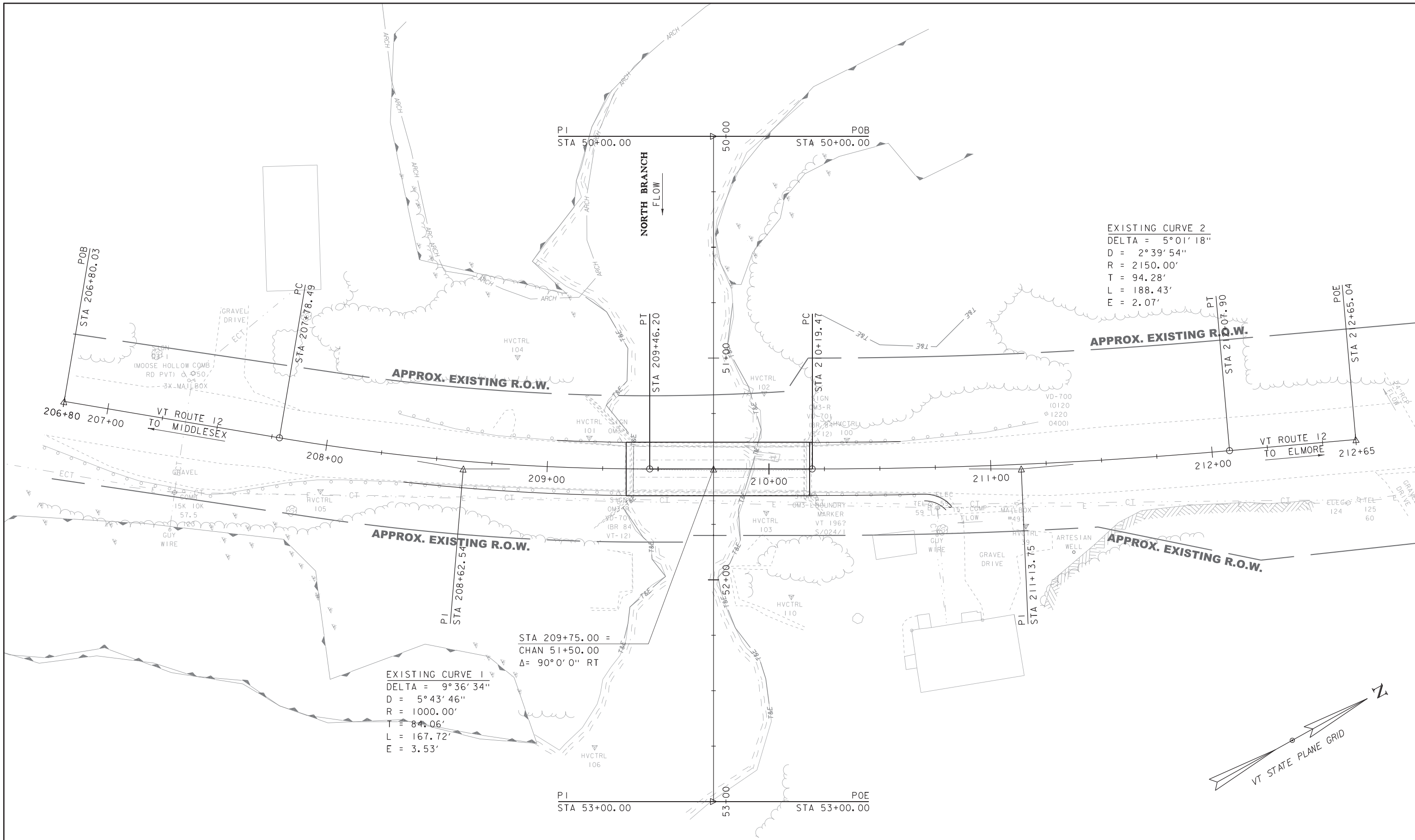

EXISTING BRIDGE INFORMATION
 BUILT 1936
 84' ROLLED BEAM
 CAST IN PLACE CONCRETE DECK

DECK REPLACEMENT LAYOUT

SCALE 1" = 20'-0"
 20 0 20

PROJECT NAME: WORCESTER	PLOT DATE: 29-APR-2020
PROJECT NUMBER: BHF 024(59)	DRAWN BY: D.D.BEARD
FILE NAME: 86e053/s86e053border.dgn	CHECKED BY: -----
PROJECT LEADER: L.J.STONE	SHEET 6 OF 16
DESIGNED BY: -----	
DECK REPLACEMENT LAYOUT SHEET	

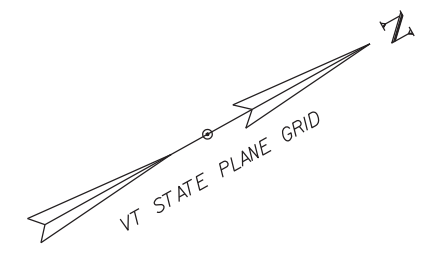

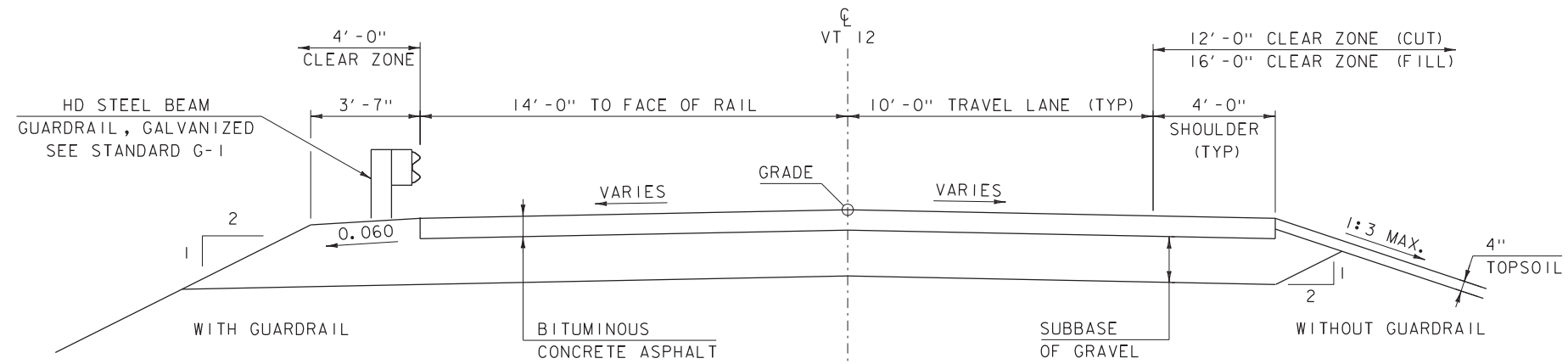

PROPOSED VT ROUTE 12 TYPICAL SECTION
SCALE 3/8" = 1'-0"

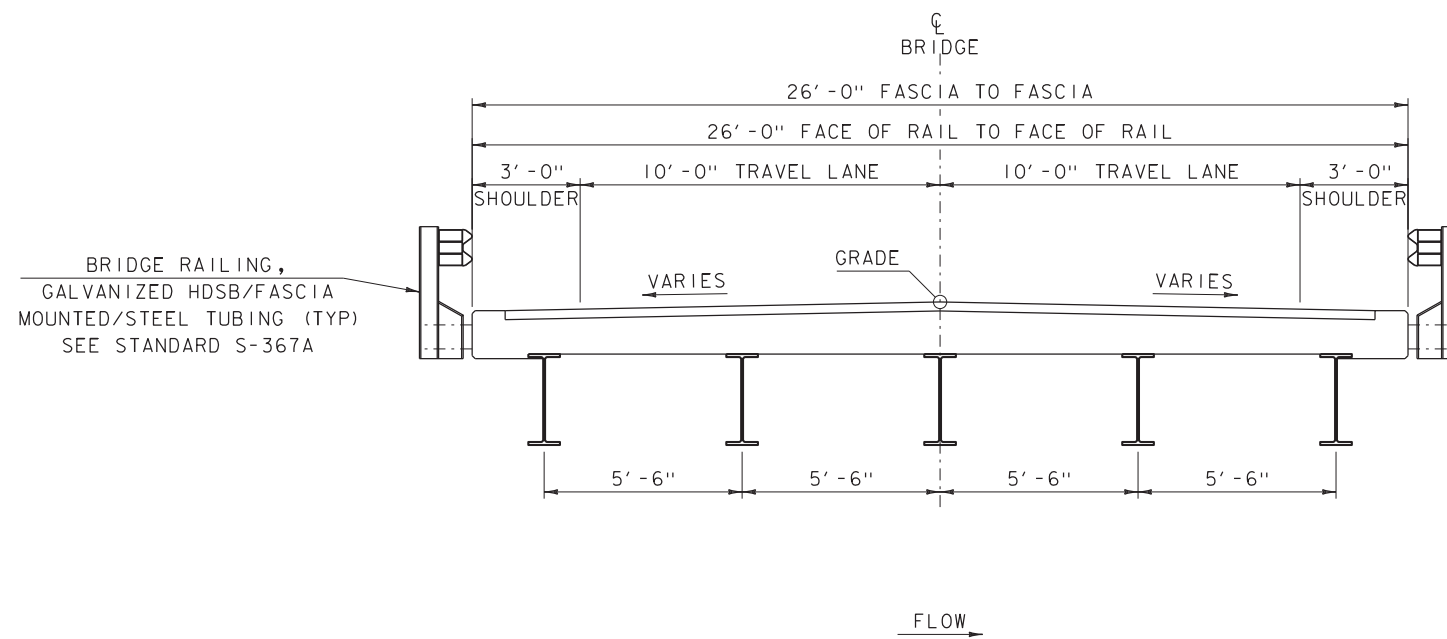

SUPERSTRUCTURE REPLACEMENT TYPICAL SECTION
SCALE 3/8" = 1'-0"

MATERIAL TOLERANCES
(IF USED ON PROJECT)

SURFACE	
- PAVEMENT (TOTAL THICKNESS)	+/- 1/4"
- AGGREGATE SURFACE COURSE	+/- 1/2"
SUBBASE	+/- 1"
SAND BORROW	+/- 1"

PROJECT NAME: WORCESTER
PROJECT NUMBER: BHF 024(59)

FILE NAME: 86e053\s86e053\typical.dgn PLOT DATE: 29-APR-2020
PROJECT LEADER: L.J.STONE DRAWN BY: D.D.BEARD
DESIGNED BY: ----- CHECKED BY: -----
SUPER REPLACEMENT TYPICAL SECTIONS SHEET 7 OF 16

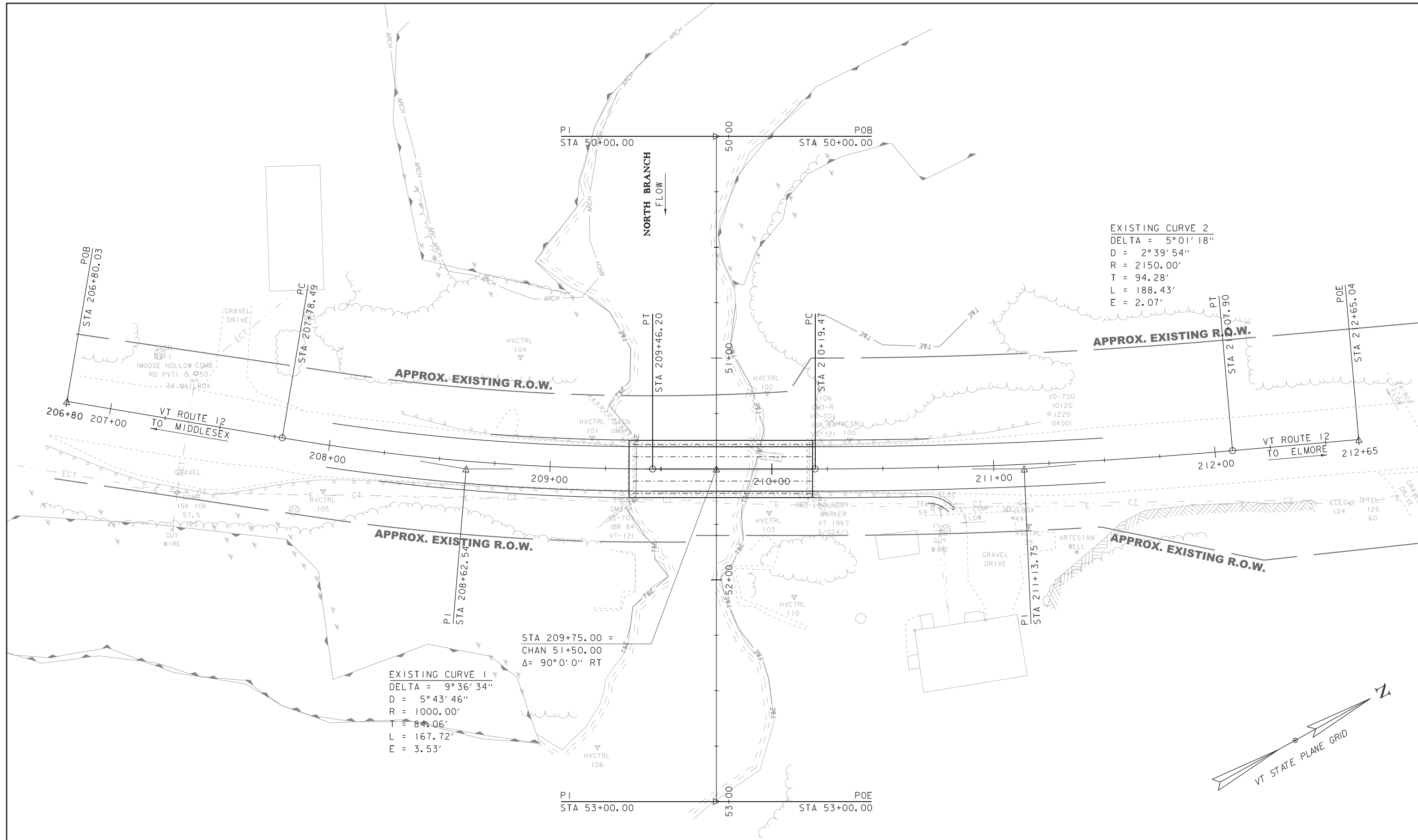

EXISTING CURVE 2
 DELTA = 5°01'18"
 D = 2°39'54"
 R = 2150.00'
 T = 94.28'
 L = 188.43'
 E = 2.07'

EXISTING CURVE 1
 DELTA = 9°36'34"
 D = 5°43'46"
 R = 1000.00'
 T = 84.06'
 L = 167.72'
 E = 3.53'

STA 209+75.00 =
 CHAN 51+50.00
 Δ = 90°0'0" RT

SUPERSTRUCTURE REPLACEMENT LAYOUT

SCALE 1" = 20'-0"
 20 0 20

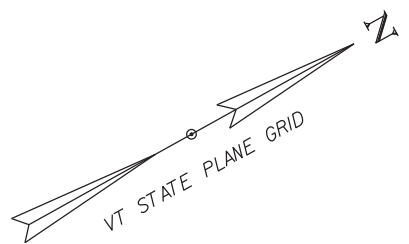

EXISTING BRIDGE INFORMATION
 BUILT 1936
 84' ROLLED BEAM
 CAST IN PLACE CONCRETE DECK

PROJECT NAME:	WORCESTER	PLOT DATE:	29-APR-2020
PROJECT NUMBER:	BHF 024(59)	DRAWN BY:	D.D.BEARD
FILE NAME:	86e053/s86e053border.dgn	CHECKED BY:	-----
PROJECT LEADER:	L.J.STONE	SHEET	8 OF 16
DESIGNED BY:	-----		
SUPERSTRUCTURE LAYOUT SHEET			

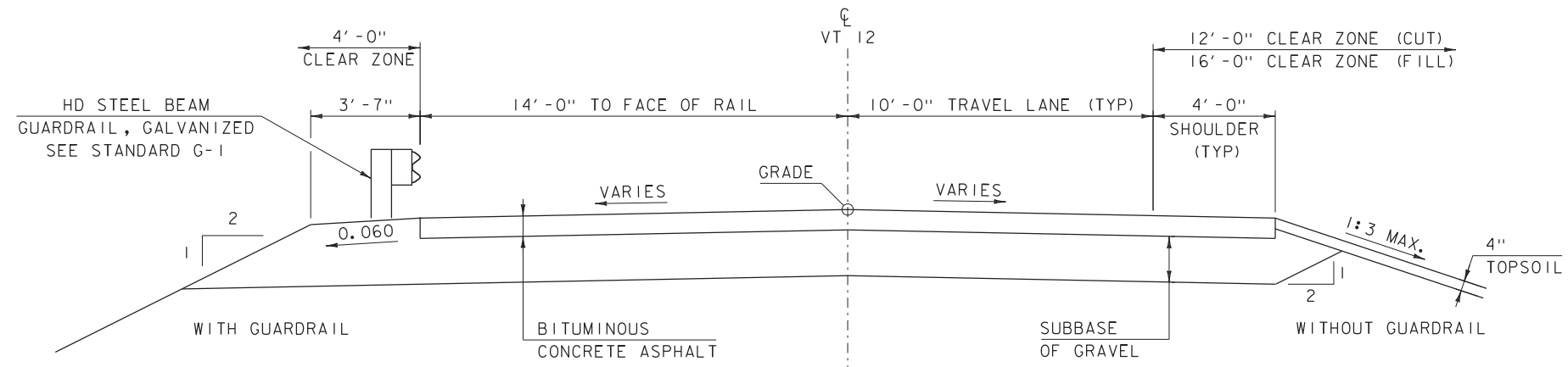

PROPOSED VT ROUTE 12 TYPICAL SECTION

SCALE 3/8" = 1'-0"

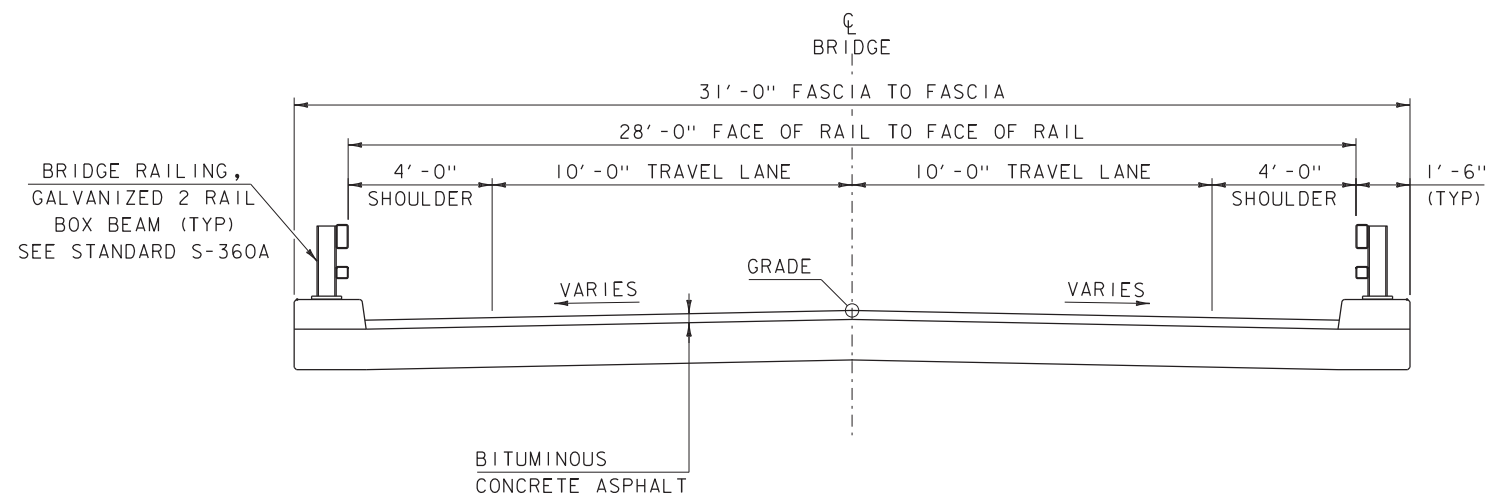

BRIDGE REPLACEMENT TYPICAL SECTION

SCALE 3/8" = 1'-0"

MATERIAL TOLERANCES
(IF USED ON PROJECT)

SURFACE	
- PAVEMENT (TOTAL THICKNESS)	+/- 1/4"
- AGGREGATE SURFACE COURSE	+/- 1/2"
SUBBASE	+/- 1"
SAND BORROW	+/- 1"

PROJECT NAME: WORCESTER
PROJECT NUMBER: BHF 024(59)

FILE NAME: 86e053\s86e053typical.dgn PLOT DATE: 29-APR-2020
PROJECT LEADER: L.J.STONE DRAWN BY: D.D.BEARD
DESIGNED BY: ----- CHECKED BY: -----
TYPICAL SECTIONS SHEET 9 OF 16

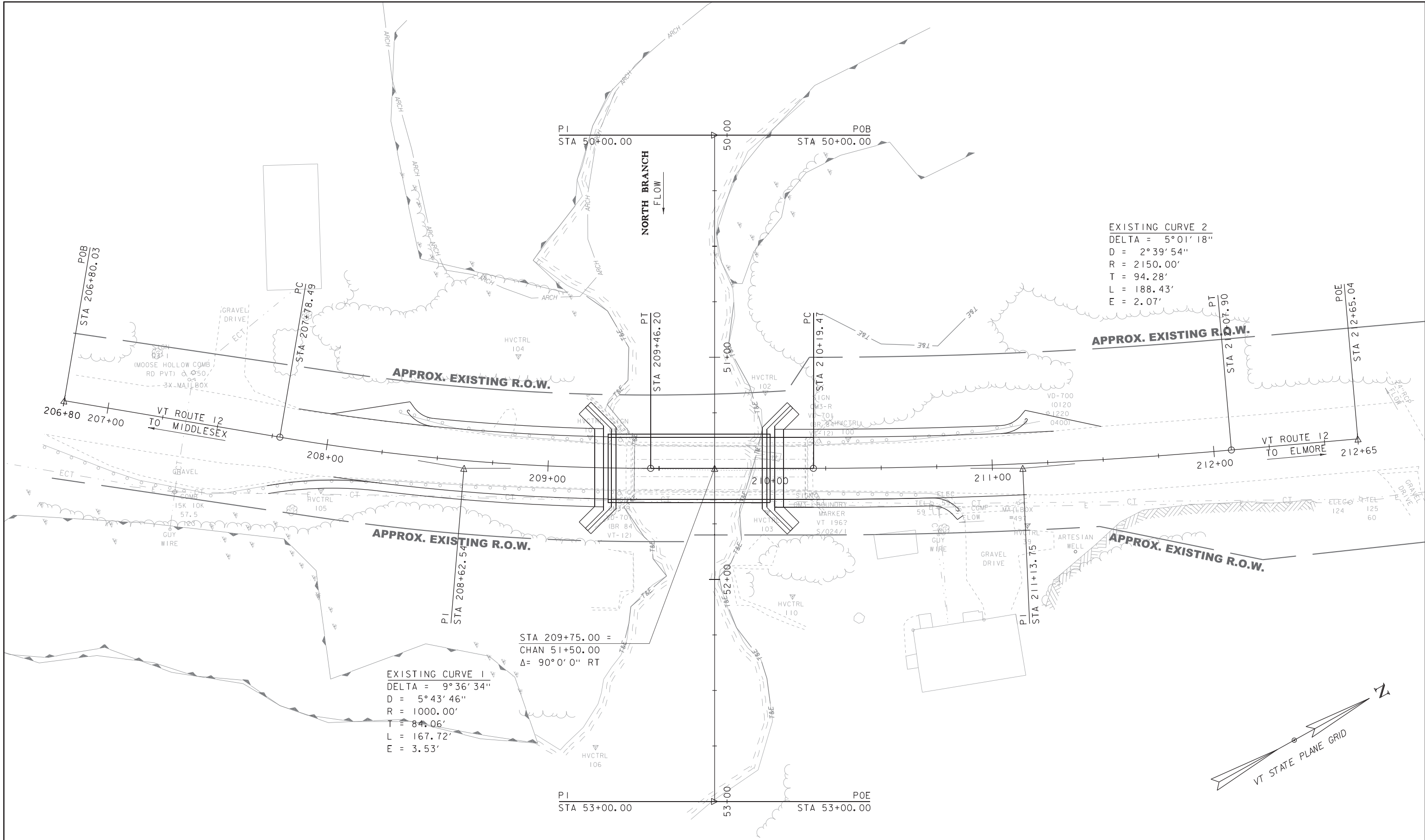

EXISTING CURVE 2
 DELTA = 5°01'18"
 D = 2°39'54"
 R = 2150.00'
 T = 94.28'
 L = 188.43'
 E = 2.07'

EXISTING CURVE 1
 DELTA = 9°36'34"
 D = 5°43'46"
 R = 1000.00'
 T = 84.06'
 L = 167.72'
 E = 3.53'

STA 209+75.00 =
 CHAN 51+50.00
 Δ = 90°0'0" RT

EXISTING BRIDGE INFORMATION
 BUILT 1936
 84' ROLLED BEAM
 CAST IN PLACE CONCRETE DECK

NEW BRIDGE LAYOUT

SCALE 1" = 20'-0"
 20 0 20

PROJECT NAME: WORCESTER	PLOT DATE: 29-APR-2020
PROJECT NUMBER: BHF 024(59)	DRAWN BY: D.D.BEARD
FILE NAME: 86e053/s86e053border.dgn	CHECKED BY: -----
PROJECT LEADER: L.J.STONE	SHEET 10 OF 16
DESIGNED BY: -----	
NEW BRIDGE LAYOUT SHEET	

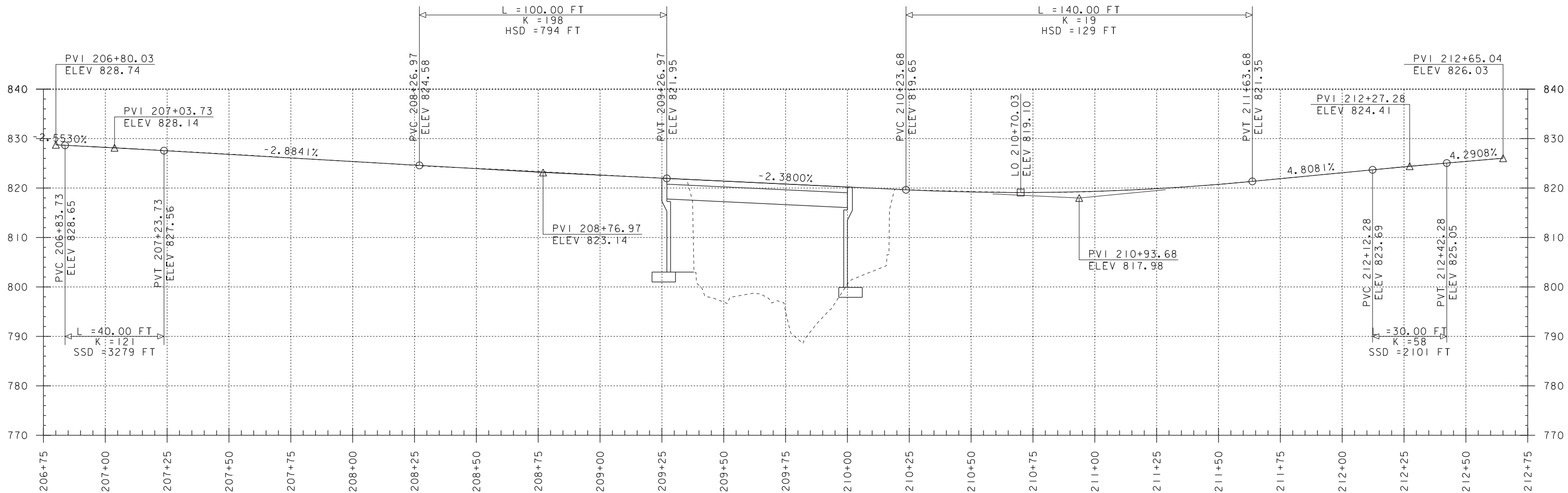

VT ROUTE 12 NEW BRIDGE PROFILE

SCALE: HORIZONTAL 1"=20'-0"
 VERTICAL 1"=10'-0"

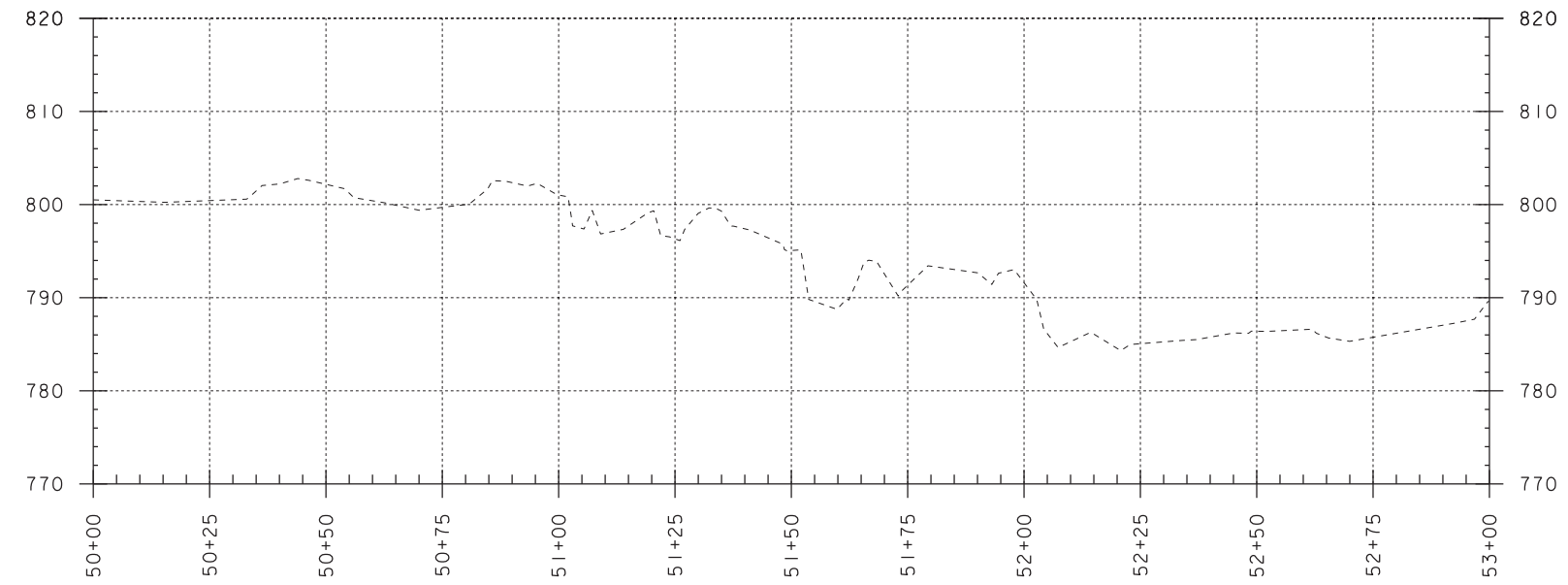

NORTH BRANCH PROFILE

SCALE: HORIZONTAL 1"=20'-0"
 VERTICAL 1"=10'-0"

NOTE:
 GRADES SHOWN TO THE NEAREST TENTH ARE EXISTING GROUND ALONG CL
 GRADES SHOWN TO THE NEAREST HUNDRETH ARE FINISH GRADE ALONG CL

PROJECT NAME:	WORCESTER	FILE NAME:	86e053/s86e053profile.dgn	PLOT DATE:	29-APR-2020
PROJECT NUMBER:	BHF 024(59)	PROJECT LEADER:	L.J.STONE	DRAWN BY:	D.D.BEARD
		DESIGNED BY:	-----	CHECKED BY:	-----
		NEW BRIDGE PROFILE SHEET		SHEET	11 OF 16

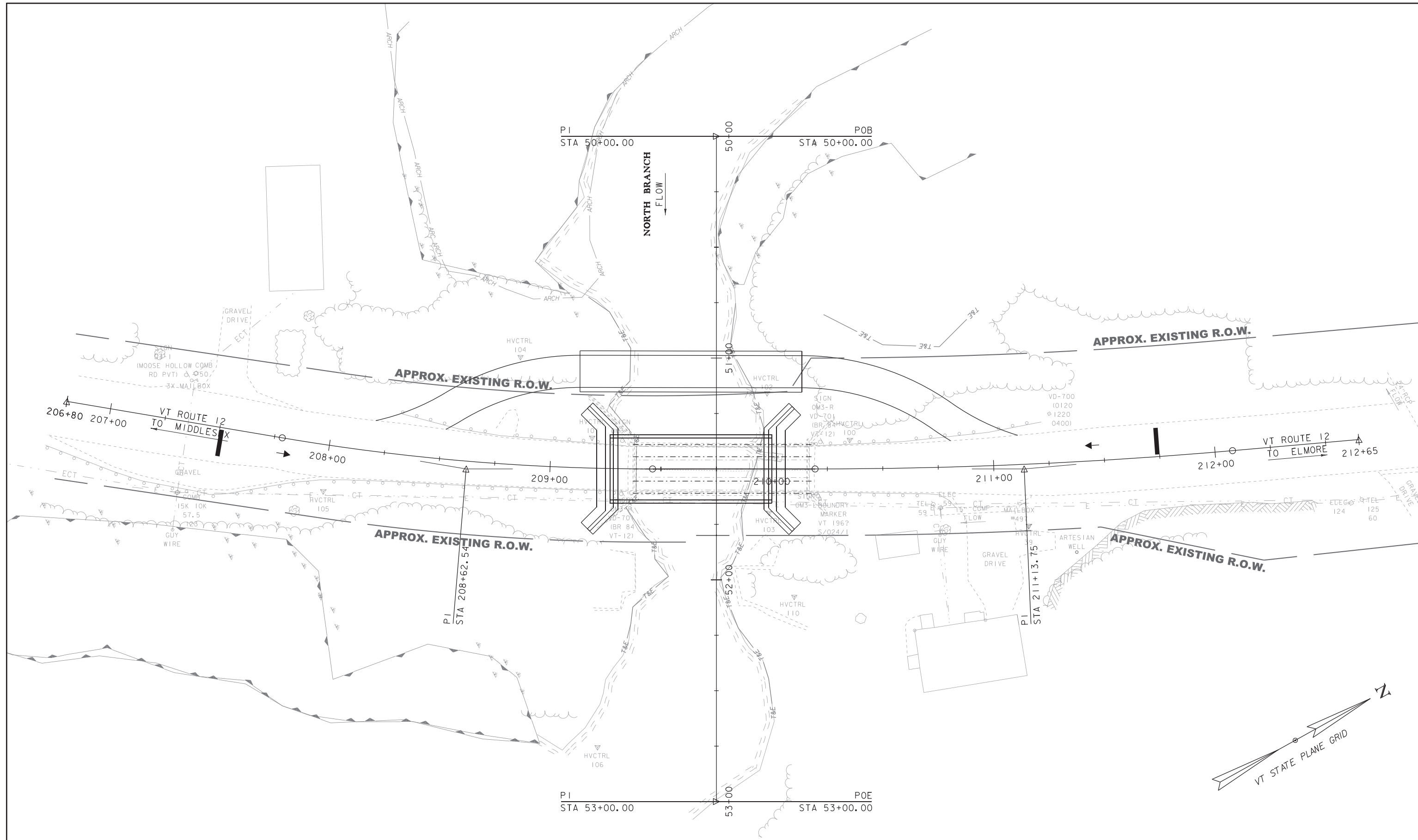

EXISTING BRIDGE INFORMATION
 BUILT 1936
 84' ROLLED BEAM
 CAST IN PLACE CONCRETE DECK

UPSTREAM TEMPORARY BRIDGE

SCALE 1" = 20'-0"
 20 0 20

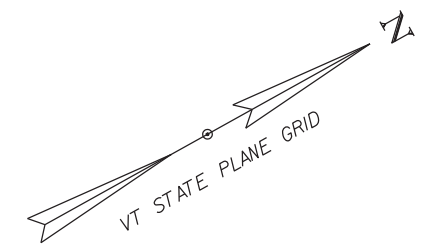

PROJECT NAME:	WORCESTER	PLOT DATE:	29-APR-2020
PROJECT NUMBER:	BHF 024(59)	DRAWN BY:	D.D.BEARD
FILE NAME:	86e053/s86e053Tcborder.dgn	CHECKED BY:	-----
PROJECT LEADER:	L.J.STONE	SHEET	12 OF 16
DESIGNED BY:	-----		
UPSTREAM TEMP BRIDGE LAYOUT SHEET			

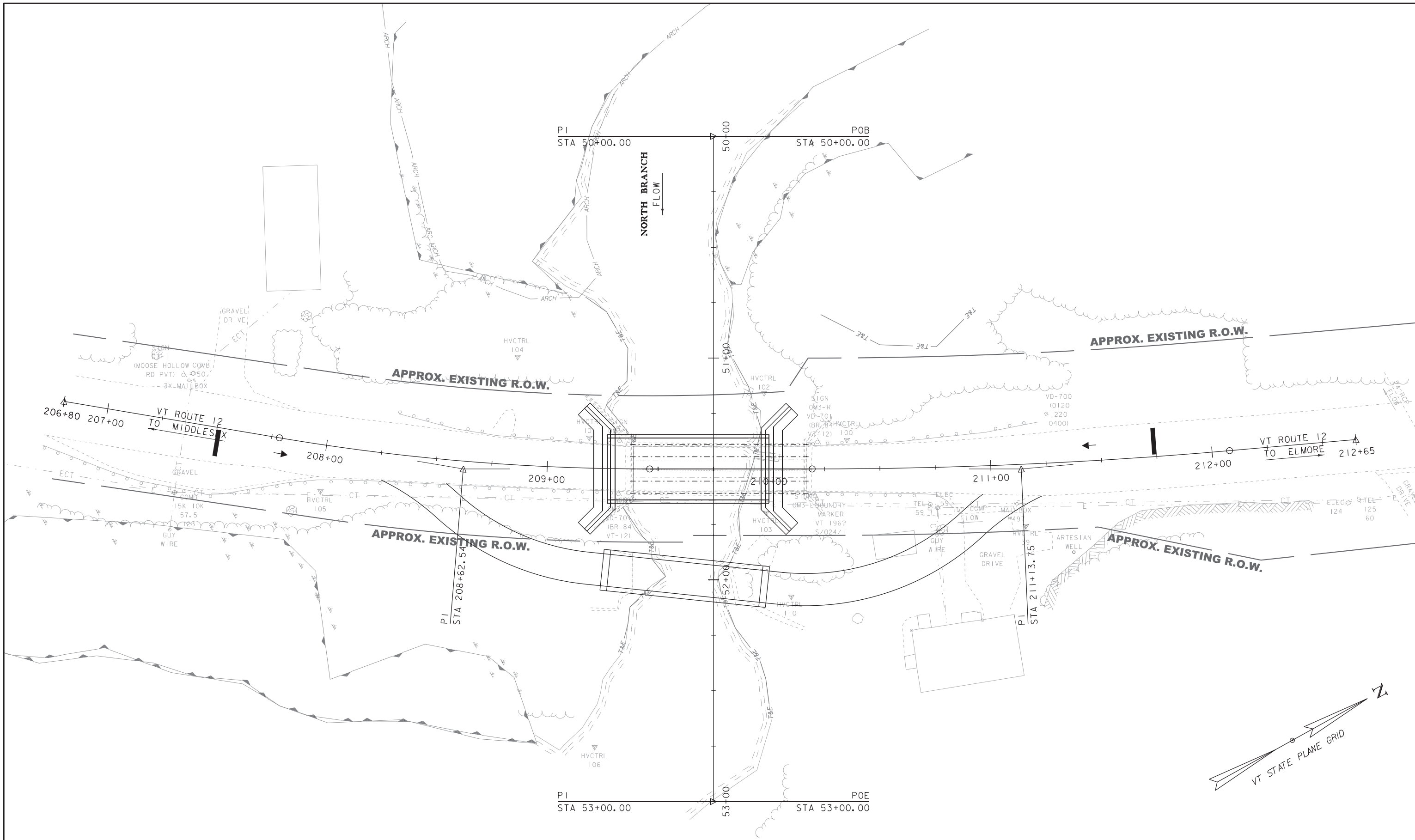

DOWNSTREAM TEMPORARY BRIDGE

SCALE 1" = 20'-0"
 20 0 20

EXISTING BRIDGE INFORMATION
 BUILT 1936
 84' ROLLED BEAM
 CAST IN PLACE CONCRETE DECK

PROJECT NAME:	WORCESTER	PLOT DATE:	29-APR-2020
PROJECT NUMBER:	BHF 024(59)	DRAWN BY:	D.D.BEARD
FILE NAME:	86e053/s86e053Tcborder.dgn	CHECKED BY:	-----
PROJECT LEADER:	L.J.STONE	DOWNSTREAM TEMP BRIDGE LAYOUT SHEET	SHEET 13 OF 16

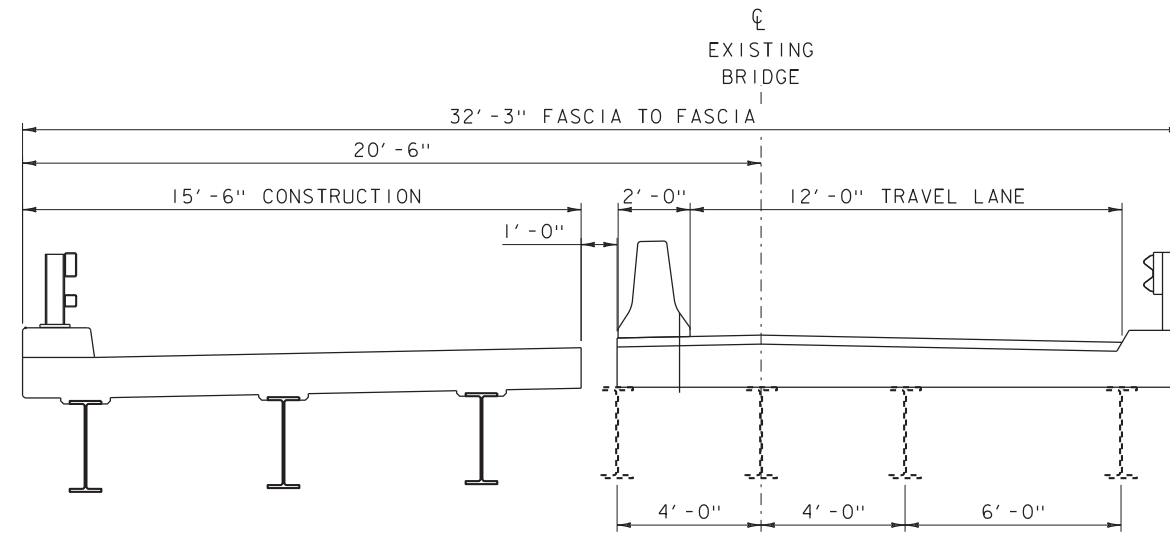

FLOW →
PHASE 1 TYPICAL SECTION
 SCALE $\frac{3}{8}" = 1'-0"$

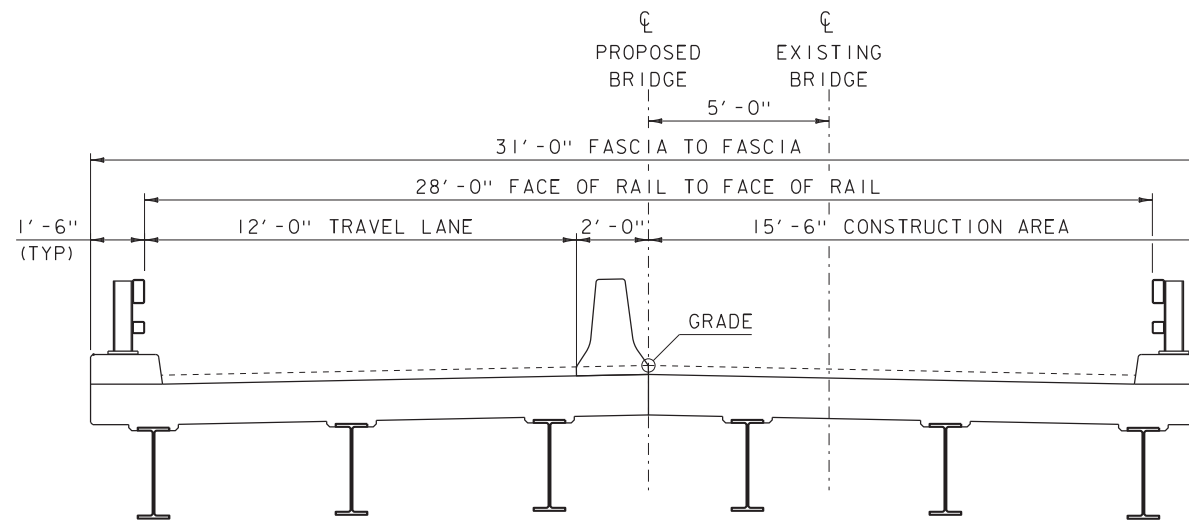

FLOW →
PHASE 2 TYPICAL SECTION
 SCALE $\frac{3}{8}" = 1'-0"$

PROJECT NAME:	WORCESTER	PLOT DATE:	29-APR-2020
PROJECT NUMBER:	BHF 024I(59)	DRAWN BY:	D.D.BEARD
FILE NAME:	86e053\s86e053typical.dgn	DESIGNED BY:	-----
REHABILITATION TYPICAL SECTIONS		CHECKED BY:	-----
		SHEET	14 OF 16

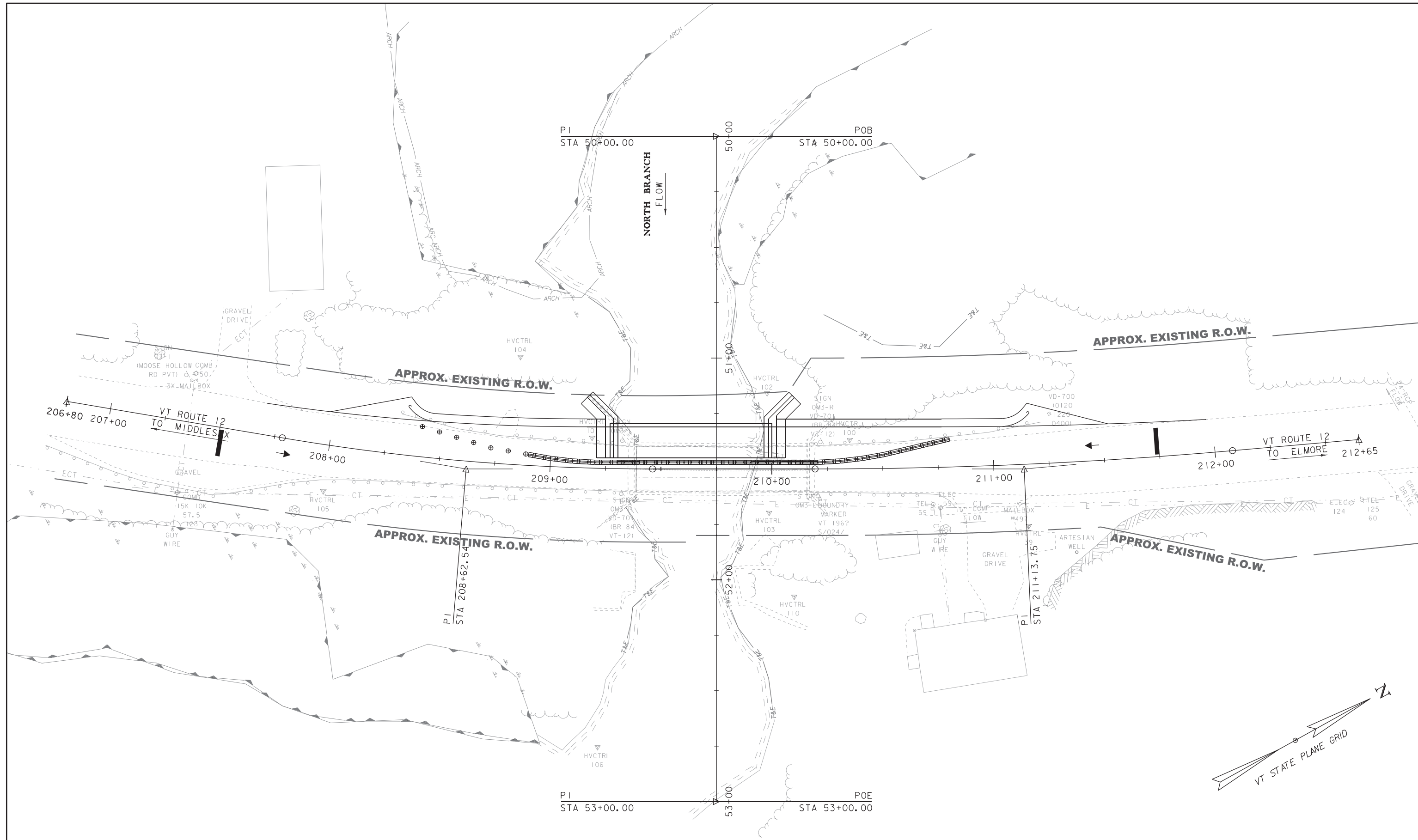

EXISTING BRIDGE INFORMATION
 BUILT 1936
 84' ROLLED BEAM
 CAST IN PLACE CONCRETE DECK

PHASE I LAYOUT

SCALE 1" = 20'-0"
 20 0 20

PROJECT NAME:	WORCESTER	PLOT DATE:	29-APR-2020
PROJECT NUMBER:	BHF 024(59)	DRAWN BY:	D.D.BEARD
FILE NAME:	86e053/s86e053Tcborder.dgn	CHECKED BY:	-----
PROJECT LEADER:	L.J.STONE	SHEET	15 OF 16
DESIGNED BY:	-----		
PHASE I LAYOUT SHEET			

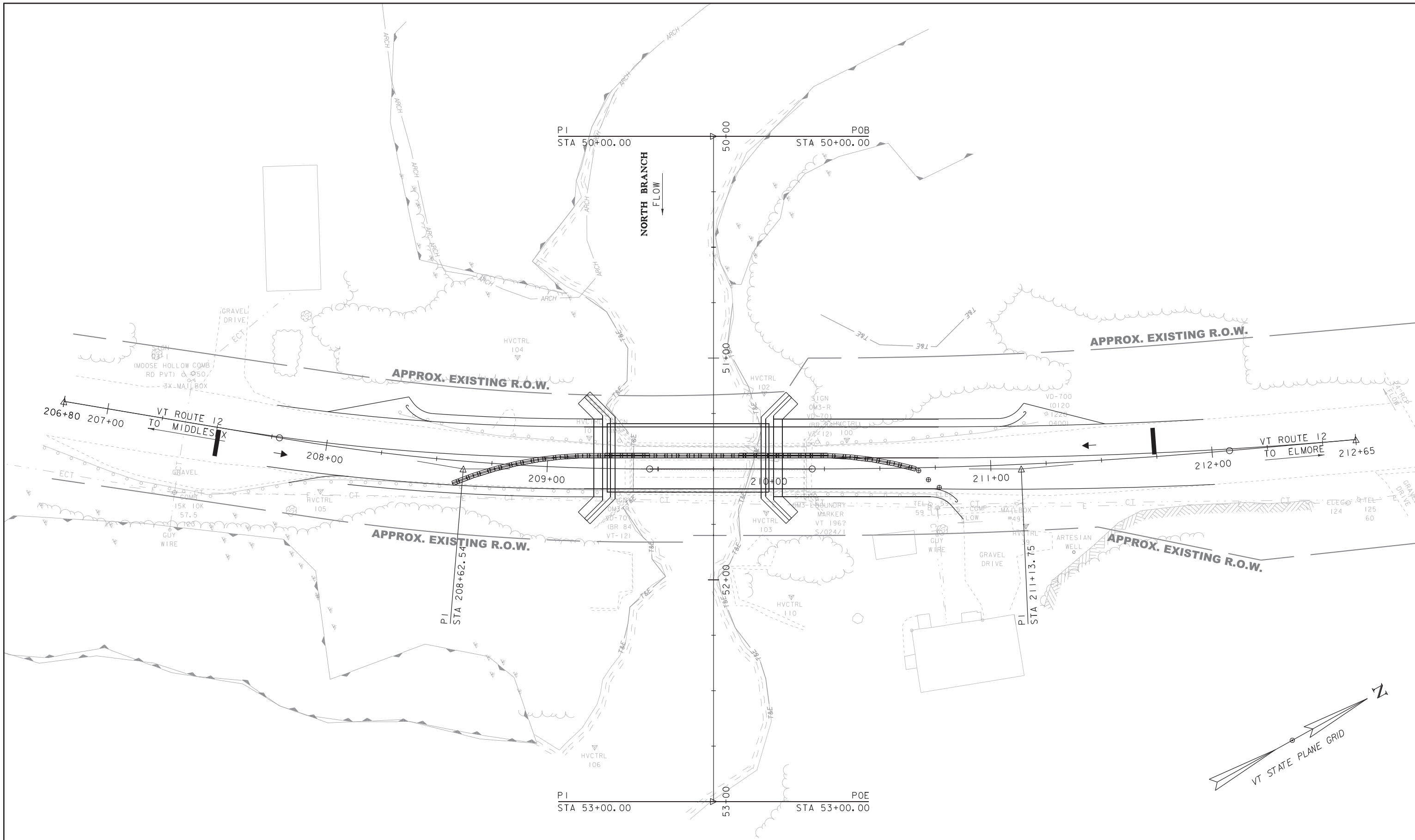

EXISTING BRIDGE INFORMATION
 BUILT 1936
 84' ROLLED BEAM
 CAST IN PLACE CONCRETE DECK

PHASE 2 LAYOUT

SCALE 1" = 20'-0"
 20 0 20

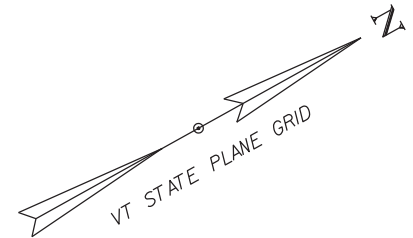

PROJECT NAME:	WORCESTER	PLOT DATE:	29-APR-2020
PROJECT NUMBER:	BHF 024(59)	DRAWN BY:	D.D.BEARD
FILE NAME:	86e053/s86e053Tcborder.dgn	CHECKED BY:	-----
PROJECT LEADER:	L.J.STONE	PHASE 2 LAYOUT SHEET	SHEET 16 OF 16