

STATE OF VERMONT
AGENCY OF TRANSPORTATION

Scoping Report

FOR
WORCESTER BF 0241(56)

VT ROUTE 12, BRIDGE 87 OVER HARDWOOD BROOK

July 30, 2020



Table of Contents

Table of Contents	2
I. Site Information	3
Need	3
Traffic	3
Design Criteria.....	4
Inspection Report Summary	4
Hydraulics.....	5
Utilities	5
Right Of Way	5
Environmental and Cultural Resources.....	5
<i>Biological:</i>	5
<i>Hazardous Materials:</i>	6
<i>Historic:</i>	6
<i>Archeological:</i>	6
<i>Stormwater:</i>	6
II. Safety	6
III. Alternatives Discussion	6
No Action.....	6
Rehabilitation	7
Structure Replacement	8
Structure Replacement Using Open Cut	8
New Bridge	10
IV. Maintenance of Traffic	11
Option 1: Off-Site Detour	11
Option 2: Phased Construction	11
Option 3: Temporary Bridge	12
V. Alternatives Summary	13
VI. Cost Matrix	14
VII. Conclusion	15
VIII. Appendices	16
Appendix A: Site Pictures	17
Appendix B: Town Map	22
Appendix C: Bridge Inspection Report	24
Appendix D: Hydraulics Memo.....	26
Appendix E: Preliminary Geotechnical Information.....	30
Appendix F: Resource ID Completion Memo	35
Appendix G: Natural Resources Memo	37
Appendix H: Archeology Memo	53
Appendix I: Historic Memo	59
Appendix J: Hazardous Sites Map	64
Appendix K: Local Input.....	66
Appendix L: Operations Input	71
Appendix M: Detour Map	74
Appendix N: Plans	77

I. Site Information

Bridge 87 is a State-owned bridge located on VT Route 12 in the Town of Worcester approximately 4.6 miles north of the junction with Calais Road. The existing conditions were gathered from a combination of a Site Visit, the Inspection Report, the Route Log and the existing Survey. See correspondence in the Appendix for more detailed information.

Roadway Classification	Major Collector
Bridge Type	Corrugated Galvanized Metal Plate Pipe Arch (CGMPPA)
Culvert Span	14 feet
Culvert Length	96 feet
Fill Over Culvert	6 feet
Year Built	1961
Ownership	State of Vermont

Need

Bridge 87 carries VT Route 12 across Hardwood Brook. The following is a list of deficiencies of Bridge 87 and VT Route 12 in this location:

1. While the culvert is in fair condition, several maintenance issues exist:
 - a. Barrel: On the outlet end, there is a large hole at the water line.
 - b. Invert: The invert of the culvert has deep pitting and heavy rust scaling in random spots. It is expected that holes will start to form in the near future.
2. The existing culvert does not meet the calculated or measured bank full width. There is a large scour hole at the outlet, indicative of an undersized structure.

Traffic

A traffic study of this site was performed by the Vermont Agency of Transportation. The traffic volumes are projected for the years 2023 and 2043.

TRAFFIC DATA	2023	2043
AADT	1,100	1,200
DHV	170	180
ADTT	70	110
%T	6.0	8.8
%D	62	62

Design Criteria

The design standards for this bridge project are the Vermont State Standards, dated October 22, 1997. Minimum standards are based on an ADT of 1,200, a DHV of 180, and a design speed of 50 mph for a Major Collector.

Design Criteria	Source	Existing Condition	Minimum Standard	Comment
Approach Lane and Shoulder Widths	VSS Table 5.3	11'4" (30')	11'3" (28')	
Bridge Lane and Shoulder Widths	VSS Section 5.7	11'4" (30')	11'3" (28') ¹	
Clear Zone Distance	VSS Table 5.5	No Issues Noted	16' fill / 10' cut (1:3 slope) 12' cut (1:4 slope)	
Banking	VSS Section 5.13	Normal Crown	8% (max)	
Speed		50 mph (Posted)	50 mph (design)	
Horizontal Alignment	AASHTO Green Book Table 3-10b	$R = \infty$	$R_{min} = 2370' @ NC$	
Vertical Grade	VSS Table 5.6	3.5% (max)	6% (max) for level terrain	
K Values for Vertical Curves	VSS Table 5.1	$K_{sag} = 164$	110 crest / 90 sag	
Vertical Clearance	VSS Section 5.8	No Issues Noted	14'-3" (min)	
Stopping Sight Distance	VSS Table 5.1	701' (Headlight Sight Distance)	400'	
Bicycle/Pedestrian Criteria	VSS Table 5.8	4' shoulder	3' Shoulder	
Hydraulics	VTrans Hydraulics Section	HW/D (Q_{50}) = 0.85 Clearspan: 14'	HW/D (Q_{50}) < 1.0 Bank Full Width: 19'	Substandard Bank Full Width
Structural Capacity	SM, Ch. 3.4.1	Structurally Sufficient	Design Live Load: HL-93	

Inspection Report Summary

Culvert Rating 5 Fair
Channel Rating 5 Fair

11/30/2016 – Barrel invert has deep pitting and just matter of time holes will be present. Large hole along south side at outlet end just outside of flow line and beneath haunch. Barrel should be considered for liner or concrete invert as shape is still fairly good. ~MJK/JS

09/28/2011 – The pipe is in satisfactory condition with some heavy rust scale along the invert but no holes where found. ~DP/JM

07/13/2006 – Culvert is in fair condition. Deep pitting along the invert will eventually lead to pinholes. Holes at the southwest end should be patched.

¹The minimum typical section required for safety and service is 10'/2' per Table 5.3 of the Vermont State Standards. A 3-foot shoulder is required per Table 5.8 of the Vermont State Standards to accommodate shared use of the roadway by bicycles. Additionally, a minimum paved width of 28' is required for winter maintenance activities per VTrans Highway Safety & Design Engineering Guidance HSDEI 11-004.

Hydraulics

The existing structure meets the current hydraulic standards of the VTrans hydraulic manual. However, the existing structure constricts the channel width, as it does not meet the 19-foot width ANR calculation for bank full width. Hydraulics has made several recommendations for a rehabilitation or replacement structure; these options are outlined in the preliminary hydraulics report in Appendix D. Regardless of the recommendation, Aquatic Organism Passage is required and will need to be incorporated into the design and construction of the project.

Utilities

The existing utilities are shown on the Existing Conditions Layout Sheet, and are as follows:

Municipal Utilities

- There are no municipal utilities within the project area.

Public Utilities

Underground:

- There are no underground facilities at this location along VT Route 12.

Aerial:

- Green Mountain Power has a single-phase line crossing over the eastern edge of the culvert. Consolidated leaves the highway right of way just south of the culvert.

It is anticipated that overhead utilities will need to be relocated for construction of the preferred alternative.

Right Of Way

The existing Right-of-Way is plotted on the Existing Conditions Layout Sheet. It is anticipated that Right-Of-Way will only be required if a temporary bridge is constructed for maintenance of traffic.

Environmental and Cultural Resources

The environmental resources present at this project are shown on the Existing Conditions Layout Sheet, and are as follows:

Biological:

Wetlands/Floodplains

There are wetland complexes mapped on both the inlet end and outlet end of the culvert within the study area. For additional information, see the Existing Conditions Layout Sheet and the Natural Resources Memo in Appendix G.

Rare, Threatened, and Endangered Species

An inventory for RTE and uncommon plant species was undertaken in the study area on September 13, 2019. An S1 ranked species and three S3 ranked species were documented within the study Area. See the Natural resources memo in Appendix G for additional information.

The USFWS IPaC mapping indicates that the project area is within the Northern Long Eared Bat's (NLEB's) habitat range. The NLEB is a federally listed threatened species. Suitable habitats for NLEB's per guidance from USFWS are: trees ≥ 3 inches in diameter that have holes, crevices,

cracks or peeling bark. During a site visit by Arrowwood Environmental, trees that fit this description on both sides of the road were identified. As the project moves forward, additional investigation is warranted to avoid impacts to potential roosting habitat.

According to the NHI database, there is a record for the S3 ranked wood turtle in the project area. See the Natural resources memo in Appendix G for additional information.

Wildlife Habitat

According to VT Fish and Wildlife mapping, the study area as a Highest Priority wildlife crossing and Highest Priority surface water and riparian area in the Vt. Conservation Design Community and Species Scale Components. The forest surrounding the study area is unfragmented with varying habitat types and considerable compositional and structural diversity. Any alternative considered will need to maintain or improve Aquatic Organism Passage (AOP).

Agricultural Soils

Prime agricultural soils are present in the vicinity of Bridge 87. The soils mapped include Rumney (Statewide (b)) and Machias (Statewide (b)) fine sandy loams. These soil types are frequently flooded but not considered highly erodible.

Hazardous Materials:

According to the Vermont Agency of Natural Resources (VANR) Vermont Hazardous Sites List, there are no hazardous waste sites located in the project area.

Historic:

Bridge 87 is not historic.

There are two properties that were identified as historic: the residence at 980 Elmore Road and the residence at 962 Elmore Road. Both buildings are considered representative samples of the milling industry that was once prevalent in the area.

Archeological:

The VTrans Archaeology Apprentice conducted a resource identification field visit on September 27th, 2019 and found no areas of archaeological sensitivity.

Stormwater:

There are no stormwater concerns for this project.

II. Safety

There have been 33 crashes along VT Route 12 in Worcester in the last five-year period. Three of those crashes were within the project area. The bridge is not located within a high crash location.

III. Alternatives Discussion

No Action

This alternative is not recommended. The culvert is in approaching poor condition and will continue to deteriorate if no action is taken. A large hole has developed in the outlet end near the

water line. The barrel invert has deep pitting and holes are expected to form if no action is taken. Something will have to be done to improve this culvert in the near future. In the interest of safety to the traveling public, the No Action alternative is not recommended. No cost estimate has been provided for this alternative since there are no immediate costs.

Rehabilitation

This alternative involves the rehabilitation of the existing corrugated metal plate pipe.

Rehabilitation options considered:

- a: Invert Repair
- b: Pipe Liner
- c: Spray on Liner

All rehabilitation options would employ the use of hydroblasting or hydrodemolition to appropriately clean the existing pipe interior prior to rehabilitation. In addition to cleaning, some grouting would be needed to plug holes in the pipe and fill all voids on the outside of the pipe. Curing in dry conditions would be required in most cases, necessitating a re-routing of the stream flow during the work and for a prescribed curing period (usually 24 hours). A headwall with beveled inlets would be recommended for all rehabilitation alternatives.

Since the minimum hydraulic opening would be substandard for all options, and any rehabilitation will reduce the waterway area, it is assumed that an improved beveled inlet would be required for each option to optimize hydraulic performance and to funnel the stream into the culvert.

a. Invert Repair

Invert repair can be utilized on corrugated steel pipe, and typically consists of paving the invert or pouring a concrete invert. Much of the deterioration is located at the invert, making this a suitable repair for the culvert. This option involves removal of the degraded invert, and pouring a 2 to 3 inch thick section of concrete in its place. Additionally, there may be repair of any holes along the circumference of the pipe, including the large perforation at the outlet of the pipe on the south side. This option would have the least impacts to the hydraulic capacity of the existing culvert. While this option is a good solution to the current degradation of the culvert invert, it adds little structural stability to the current structure. There has been no evidence of crushing or squashing, and as such, additional structural capacity is not required.

b. Pipe Liner:

A pipe liner involves inserting a culvert liner into the existing culvert, and grouting between the two. Sliplining can be done using several different types of pipe material including corrugated steel, aluminum, reinforced concrete, and polyethylene, and can restore the structural integrity of the culvert. The outside diameter of the pipe used for sliplining is generally specified to be at least 4 inches smaller than the inside diameter of the host pipe to allow the grout to be injected into the annular space between the two pipes. A greater reduction would be required at this site since the existing pipe is an arch. The reduced waterway would have a substandard bankfull width and may not meet the minimum hydraulic standard. A liner option is anticipated to have the longest life expectancy of the rehabilitation alternatives, since the grout provides an increased structural capacity, prevents liner collapse, prevents fatigue failure, stabilizes the pipe, extends the design life from uncertainty to at least 30 years, and resists temperature changes.

c. Spray-On Liners

Spray-On liners provide a new rigid interior surface for the pipe and use either cementitious materials (polymer-enhanced cement mortar) or polyurea. These liners are spray applied either by hand or machine, although some users have had better quality control with hand-applied methods. Cementitious liners installed by these methods can provide full structural support, depending on thickness applied. Proper curing is essential to using spray-on liners to avoid bond failures. There could be water quality impacts associated with the application of these liners, their degree of impact related to selection of materials, and adherence to curing requirements. If a spray-on liner is selected, the polymer-enhanced cement mortar is recommended for environmental and safety reasons. Temporary Right of Way would need to be acquired to provide a staging area at each end to accomplish this alternative.

Advantages: A repair alternative would address the ongoing deterioration issues with the invert of the existing culvert without affecting traffic flow, and with minimum upfront costs. Additionally, it would have minimal impacts on resources.

Disadvantages: The rehabilitation alternative is only a repair and not a new structure. The life span of the repair work is estimated to be 15 to 30 years. Also, the existing culvert does not meet the hydraulic standard, and the rehabilitation option would have a smaller hydraulic opening. Aquatic Organism Passage and wildlife connectivity would not be improved. It is assumed that for any rehabilitation alternative, temporary right-of-way will be necessary for the contractor's access to the ends of the culvert.

Maintenance of Traffic: The rehabilitation alternative has minimal effect on traffic. Traffic will remain open during the duration of the project, with the exception of intermittent lane closures for some construction activities.

Structure Replacement

The preliminary hydraulics report suggests several possible configurations for a new structure, including a new precast box, an open bottom precast concrete arch or frame, or a new bridge with either vertical face abutments.

Structure Replacement Using Open Cut

Culvert replacement using an open cut is considered a more cost-effective solution than trenchless methods when there is a shallow amount of fill over the culvert.

This option involves removing the existing Corrugated Galvanized Metal Plate Pipe Arch and replacing it with a new precast structure having a waterway opening 19-feet wide and 7-feet high. Since there is approximately 6 feet of fill above the existing culvert, there would not be a considerable amount of earthwork. Any new structure should have flared wingwalls at the inlet and outlet to make a smooth transition between the channel and the culvert. The various considerations under this option include: the roadway width, structure type, culvert length and skew, and roadway alignment.

a. Roadway Width

The existing roadway currently has 11-foot-wide lanes and 4-foot-wide shoulders, which meets the minimum standard of 28-feet as set forth in the Vermont State Standards. Since a new 75+ year structure is being proposed, the roadway geometry should meet the minimum standards. A 30-foot width roadway will be proposed through the project area to match to existing conditions.

b. Structure Type

The most common structure type for the recommended hydraulic opening is a 4-sided concrete box culvert, or a 3-sided open bottom concrete structure.

It is preferred that the structure be a precast 4-sided concrete box culvert. This type of structure would provide protection against scour and undermining and would require less excavation than an open bottomed structure. Additionally, it would have a shorter construction duration compared to an open bottom structure, since footings would not have to be placed six feet below the stream bed. Based on available information from nearby wells, shallow ledge may be encountered. As such, a precast box may not be feasible without blasting. Borings should be requested early on in design process to determine the most appropriate structure type.

If an arch or frame is used, it should be founded either on bedrock or a minimum of 6-feet below the channel bottom. Additionally, full-depth headwalls should be installed.

c. Culvert Size, Length and Skew

The existing culvert has a span of 14 feet, which constricts the natural channel width. If a new structure is chosen Hydraulics has recommended a box with a 19-foot-wide and 10-foot-high inside opening, with 12-inch-high bed retention sills spaced no more than 8 feet apart. The top of the sills should be buried 3-feet with E-Stone, Type III, resulting in a waterway opening with a rise of 7 feet. This culvert will have no roadway overtopping up and including the Q₁₀₀ design flow. In order to accommodate a 30-foot-wide roadway, the proposed barrel length will be approximately 100 feet long. The culvert will have a skew of 45 degrees to the roadway to match the existing skew of the channel.

d. Roadway Alignment

The existing horizontal and vertical alignments meet the minimum standards as set forth by the AASHTO Green Book. As such it is recommended that the roadway alignment remains unchanged.

e. Maintenance of Traffic

Either an off-site detour, phased construction, or a temporary bridge would be appropriate measures for traffic control at this site.

Advantages: This alternative would address the structural deficiencies of the existing bridge, with a brand-new culvert with a 75-year design life. This option would meet the minimum hydraulic standards and provide adequate AOP. This option would have minimal future maintenance costs.

Disadvantages: This option has the higher upfront costs compared to the rehabilitation options.

New Bridge

This alternative would replace the existing culvert with a new bridge at the existing location. The various considerations under this option include: the bridge width and length, skew, superstructure type and substructure type.

a. Bridge Width

The existing lane widths and shoulders on VT Route 12 over the culvert are 11-foot-wide and 4-foot-wide respectively; this exceeds the minimum standard of 28-feet as set forth in the Vermont State Standards. Since a new 75+ year bridge is being proposed, the bridge geometry should meet the minimum standards. A 30-foot rail-to-rail distance is proposed over the bridge.

b. Bridge Length and Skew

The existing culvert has a 14-foot span with a 45-degree skew to the roadway. The required bankfull width is 19 feet and the brook also follows the 45-degree skew to the roadway. In order to meet the minimum bankfull width requirements, the bridge would have an approximate 90-foot span based on a maximum 20-degree skew and the layout procedures for integral abutment bridges. If spread footings are preferred due to subsurface conditions, the bridge would have a span of approximately 35 feet.

c. Superstructure Type

If the bridge is closed during construction, a precast structure would be the preferred choice, due to decreased construction time. The possible 35-foot length bridge types that are most commonly used in Vermont are solid slabs, NEXT Beams, and steel beams with a composite concrete deck (Precast Bridge Units). If an integral abutment bridge with a span of 90-feet is preferred, the bridge type would likely be steel beams with a composite concrete deck. If VT Route 12 through the project area is to remain open during construction, then a cast-in-place deck on steel beams or a cast-in-place solid slab would be recommended as these types of superstructures are more cost efficient than precast superstructure types. The superstructure depth is not critical for hydraulics; therefore, the beam depth is not a controlling factor in choosing a superstructure type.

d. Substructure Type

There are ledge cuts located along VT Route 12 both north and south of the culvert. Available information on nearby water wells indicates that bedrock may be encountered at a depth of 30 feet below finished grade. Borings should be taken at the project site, to determine if the subsurface is conducive for an integral abutment at this location. This type of substructure would provide the best scour protection. If it is determined that driving piles will be difficult, then the substructure should be reinforced concrete abutments on spread footings. Any rapid construction alternative should have sufficient subsurface information to verify the in-situ conditions. In order to reduce construction time, precast abutment components may be used where possible. The preliminary geotechnical report can be found in Appendix E.

e. Maintenance of Traffic:

Either a temporary bridge, phased construction, or an offsite detour could be utilized for traffic control.

IV. Maintenance of Traffic

The Vermont Agency of Transportation has created an Accelerated Bridge Program, which focuses on faster delivery of construction plans, permitting, and Right of Way, as well as faster construction of projects in the field. One practice that helps in this endeavor is closing bridges for portions of the construction period, rather than providing temporary bridges. In addition to saving money, the intention is to minimize the closure period with faster construction techniques and incentives to contractors to complete projects early. The Agency will consider the closure option on most projects where rapid reconstruction or rehabilitation is feasible. The use of prefabricated elements in new bridges will also expedite construction schedules. This can apply to decks, superstructures, and substructures. Accelerated Construction should provide enhanced safety for the workers and the travelling public while maintaining project quality. The following options have been considered:

Option 1: Off-Site Detour

This option would close the bridge and reroute traffic onto an official, signed State detour. There are two detours that could be used if the bridge is closed during construction. The two potential State-signed detours are as follows:

1. VT Route 12, to VT Route 100, and US Route 2, back to VT Route 12 (61 miles end-to-end)
2. VT Route 12, to US Route 2, VT Route 14, and VT Route 15, back to VT Route 12 VT Route 100, and White Road, back to Knowles Flat Road (66 miles end-to-end)

There are no local bypass routes available. Local bypass routes are local roads that may see an increase in traffic from local passenger cars if VT Route 12 is closed during construction. Local bypass routes are not signed detours but may experience higher traffic volumes during a road closure.

A map of the detour routes can be found in Appendix M.

Advantages: Utilizing an off-site detour would eliminate the need to use a temporary bridge or phase construction to maintain traffic. This would decrease the cost and amount of time required to construct a project in this location. The impacts and amount of temporary rights required to construct a project in this location would also be reduced for this option. The safety of both construction workers and the travelling public will be improved by removing traffic from the construction site.

Disadvantages: Traffic flow would not be maintained through the project corridor during construction.

Option 2: Phased Construction

Phased construction is the maintenance of traffic on the existing bridge while building one lane at a time of the proposed structure. This allows keeping the road open during construction, while having minimal impacts to adjacent property owners and environmental resources.

While the time required to develop a phased construction project would remain the same, the time required to complete a phased construction project increases because some of the construction tasks have to be performed multiple times. In addition to the increased design and construction costs

mentioned above, the costs also increase for phased construction because of the inconvenience of working around traffic and the effort involved in coordinating the joints between the phases. Another negative aspect of phased construction is the decreased safety of the workers and vehicular traffic, which is caused by increasing the proximity and extending the duration that workers and moving vehicles are operating in the same confined space. Phased construction is usually considered when the benefits include reduced impacts to resources and decreased costs and development time by not requiring the purchase of additional ROW.

Based on the current traffic volumes, it is acceptable to close one lane of traffic, and maintain one lane of traffic, both ways, with a traffic signal. There is approximately 6 feet of vertical fill over the existing culvert, which would need to be held back for phased construction.

Advantages: Traffic flow would be maintained through the project corridor during construction. Also, this option would have minimal impacts to adjacent properties and environmental and cultural resources. Right-of-Way would not be required for this maintenance of traffic option.

Disadvantages: Phased construction generally involves higher costs and complexity of construction. Costs are usually higher and construction duration is longer, since many construction activities have to be performed two times. Additionally, since cars are traveling near construction activity, there is decreased safety. There would be some delays and disruption to traffic, since the road would be reduced to one-way traffic.

Option 3: Temporary Bridge

From a constructability standpoint, a temporary bridge could be placed either upstream or downstream of the existing structure. Downstream of the culvert, there is a large scour pool, and a temporary bridge on that side would have a greater length. The culvert is located in a wooded area, and a temporary bridge on either side of the road would require tree clearing and would have impacts to wetlands. On the upstream (eastern) side of the culvert, there are aerial utilities that would need to be relocated for a temporary bridge. Both an upstream and downstream temporary bridge alignment would have limits outside the existing Right-of-Way.

Additional costs would be incurred to construct a temporary bridge, including the cost of fill for the approaches and the bridge itself, installation and removal of the temporary bridges and approaches, restoration of the disturbed area, and the time and money associated with the temporary Right-of-Way.

If a temporary bridge is chosen as the preferred method of traffic control, based on the traffic volumes and site conditions, it should be a one-lane bridge with alternating traffic to minimize impacts to surrounding resources. See the Temporary Bridge Layout Sheets in Appendix N.

Advantages: Traffic flow can be maintained along the VT Route 12 corridor.

Disadvantages: This option would require additional Right-of-Way acquisition. This option would have adverse impacts to surrounding resources including wetlands. There would be decreased safety to the workers and to vehicular traffic, because of cars driving near the construction site, and construction vehicles entering and exiting the construction site. This traffic control option would be more costly, and time consuming than an offsite detour. The bridge is surrounded by wooded areas, both upstream and downstream. A number of trees would need to be cut down for this temporary condition.

V. Alternatives Summary

Based on the existing site conditions, culvert condition, and recommendations from hydraulics and others, the following alternatives are offered:

- Alternative 1: Culvert Rehabilitation with Traffic Maintained on Existing Culvert
 - a. Invert Repair
 - b. 90-inch Culvert Liner
 - c. Spray-On Culvert Liner
- Alternative 2a: New Precast Box Culvert or 3-Sided Structure (open cut) with Traffic Maintained on Offsite Detour
- Alternative 2b: New Precast Box Culvert or 3-Sided Structure (open cut) with Traffic Maintained with Phased Construction
- Alternative 2c: New Precast Box Culvert or 3-Sided Structure (open cut) with Traffic Maintained on a Temporary Bridge
- Alternative 3a: New integral abutment bridge with Traffic Maintained on Offsite Detour
- Alternative 3b: New integral abutment bridge with Traffic Maintained with Phased Construction
- Alternative 3c: New integral abutment bridge with Traffic Maintained on a Temporary Bridge

A cost evaluation for each of the alternatives is shown below.

VI. Cost Matrix²

Worcester BF 0241(56)		Do Nothing	Alternative 1			Alternative 2			Alternative 3		
			Culvert Rehabilitation			New 3-Sided Structure			New Integral Abutment Bridge		
			a. Concrete Invert	b. Slipliner	c. Spray On Liner	a. Offsite Detour	b. Phased Construction	c. Temporary Bridge	a. Offsite Detour	b. Phased Construction	c. Temporary Bridge
COST	Bridge Cost	\$0	124,480	306,131	182,080	507,863	943,237	820,206	1,116,800	921,200	801,000
	Removal of Structure	\$0	134,400	134,400	134,400	134,400	154,560	134,400	105,000	120,750	105,000
	Roadway	\$0	70,792	85,376	84,728	195,240	356,888	248,270	191,000	323,000	225,000
	Maintenance of Traffic	\$0	35,840	35,840	35,840	199,300	359,100	354,040	174,300	296,600	329,040
	Construction Costs	\$0	365,512	561,748	437,048	1,036,803	1,813,785	1,556,916	1,587,100	1,661,550	1,460,040
	Construction Engineering & Contingencies	\$0	73,102	196,612	152,967	259,201	453,446	389,229	365,033	498,465	365,010
	Accelerated Premium	\$0	0	0	0	41,472	0	0	111,097	0	0
	Total Construction Costs w CEC	\$0	438,614	758,359	590,015	1,337,476	2,267,232	1,946,145	2,063,230	2,160,015	1,825,050
	Preliminary Engineering ³	\$0	109,654	168,524	131,114	259,201	453,446	389,229	238,065	332,310	292,008
	Right of Way	\$0	0	0	0	0	0	20,000	0	0	20,000
	Total Project Costs	\$0	548,268	926,884	721,129	1,596,677	2,720,678	2,355,374	2,301,295	2,492,325	2,137,058
Annualized Costs	\$0	27,413	23,172	18,028	21,289	36,276	31,405	30,684	33,231	28,494	
TOWN SHARE			No Local Share								
TOWN %			No Local Share								
SCHEDULEING	Project Development Duration ⁴	N/A	2 years	2 years	2 years	2 years	2 years	2 years	2 years	2 years	2 years
	Construction Duration	N/A	4 months	4 months	4 months	6 months	9 months	9 months	6 months	9 months	9 months
	Closure Duration (If Applicable)	N/A	N/A	N/A	N/A	7 days	N/A	N/A	30 days	N/A	N/A
ENGINEERING	Typical Section - Roadway (feet)	28	28	28	28	28	28	28	28	28	28
	Typical Section - Bridge (feet)	4' - 11' - 11' - 4'	4' - 11' - 11' - 4'	4' - 11' - 11' - 4'	4' - 11' - 11' - 4'	4' - 11' - 11' - 4'	4' - 11' - 11' - 4'	4' - 11' - 11' - 4'	4' - 11' - 11' - 4'	4' - 11' - 11' - 4'	4' - 11' - 11' - 4'
	Geometric Design Criteria	Meets Minimum Standards	Meets Minimum Standards	Meets Minimum Standards	Meets Minimum Standards	Meets Minimum Standards	Meets Minimum Standards	Meets Minimum Standards	Meets Minimum Standards	Meets Minimum Standards	Meets Minimum Standards
	Traffic Safety	No Change	Improved	Improved	Improved	Improved	Improved	Improved	Improved	Improved	Improved
	Alignment Change	No Change	No Change	No Change	No Change	No Change	No Change	No Change	No Change	No Change	No Change
	Bicycle Access	No Change	No Change	No Change	No Change	No Change	No Change	No Change	No Change	No Change	No Change
	Pedestrian Access	No Change	No Change	No Change	No Change	No Change	No Change	No Change	No Change	No Change	No Change
	Hydraulics	Substandard BFW	Substandard BFW	Substandard BFW	Substandard BFW	Meets Minimum Standards	Meets Minimum Standards	Meets Minimum Standards	Meets Minimum Standards	Meets Minimum Standards	Meets Minimum Standards
Utilities	No Change	No Change	No Change	No Change	Aerial Relocation	Aerial Relocation	Aerial Relocation	Aerial Relocation	Aerial Relocation	Aerial Relocation	
OTHER	ROW Acquisition	No Change	No	No	No	No	No	Yes	No	No	Yes
	Road Closure	No Change	No	No	No	Yes	No	No	Yes	No	No
	Design Life	< 10 years	20	40	40	75	75	75	75	75	75

² Costs are estimates only, used for comparison purposes.

³ Preliminary Engineering costs are estimated starting from the end of the Project Definition Phase.

⁴ Project Development Durations are starting from the end of the Project Definition Phase.

VII. Conclusion

Alternative 2b or 2c is recommended; to replace the existing culvert with a new precast box while one lane of alternating traffic is maintained during construction..

Structure:

The existing culvert is 60 years old and has reached the end of its anticipated design life. Additionally, the current culvert does not meet the minimum hydraulic standard for bank full width, and would become even more substandard if rehabilitated, further warranting a full replacement. Aquatic organism passage (AOP) is important for this culvert which can be better accommodated with a full bridge replacement.

Due to the amount of fill over the existing culvert along with the required bank full width of a new structure, a new buried structure is more cost effective than a bridge.

The cost of a precast box is slightly higher than a new bridge. However, the maintenance costs are lower for a buried structure since it is not directly exposed to deicing salts.

The new culvert will be a 19-foot x 10-foot precast concrete box culvert, as per the VTrans Hydraulic Section's recommendation. The new precast box will have bed retention sills, to allow for a natural channel bottom to form, accommodating aquatic organism passage. Since the precast culvert will have a closed bottom, it will be protected from scour. In order to satisfy the AOP needs, the culvert invert should be buried 3-feet with E-Stone, Type III placed along the length of the channel bottom through the culvert, resulting in a 7-foot-high waterway opening. The new culvert should have headwalls that extend four feet below the channel bottom at the inlet and the outlet to prevent undermining. This structure will have no roadway overtopping below the Q₁₀₀ storm event.

Traffic Control:

The regional detour routes available have an end-to-end distance of approximately 60 miles, with no local bypass routes available. This distance is considered long for a detour route, and as such, traffic should be maintained through the project area. The recommended method of traffic control is to either construct a temporary bridge to one side of the existing roadway or to construct the new bridge in phases. Phased construction may be preferred over a temporary bridge since it will have less impacts to wetlands, Right-of-Way, and aerial utilities.

Coordination with other projects:

There are several projects in the State Highway Bridge Program within the project area that are currently in the scoping phase of project development. The projects are as follows:

- ELMORE BF 0241(55) 19B212, VT Route 12, Bridge 94 over unnamed brook.
- ELMORE STP CULV(64) 18B003, VT Route 12, Bridge 90 over unnamed brook.
- WORCESTER BF 0241(56) 19B213, VT Route 12, Bridge 87 over Hardwood brook.
- WORCESTER BF 0241(57) 19B214, VT Route 12, Bridge 89 over North brook.
- WORCESTER BF 0241(59) 86E053, VT Route 12, Bridge 84 over the north branch of Winooski river

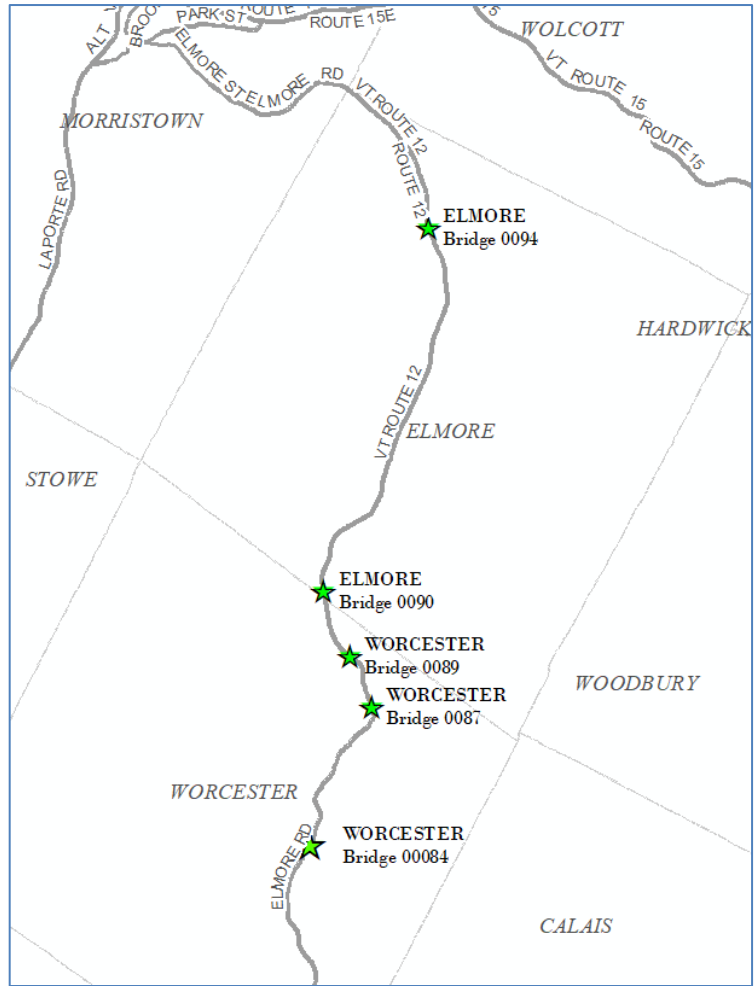

Consideration should be given to bundling these projects for design and/or construction.

VIII. Appendices

- Appendix A: Site Pictures
- Appendix B: Town Map
- Appendix C: Bridge Inspection Report
- Appendix D: Hydraulics Memo
- Appendix E: Preliminary Geotechnical Information
- Appendix F: Resource Identification Completion Memo
- Appendix G: Natural Resources Memo
- Appendix H: Archeology Memo
- Appendix I: Historic Memo
- Appendix J: Hazardous Sites Map
- Appendix K: Local Input
- Appendix L: Operations Input
- Appendix M: Detour Map
- Appendix N: Plans

Appendix A: Site Pictures



Picture 1: Looking North on VT Route 12 over Bridge 87



Picture 2: Looking South on VT Route 12 over Bridge 87



Picture 3: Culvert Outlet



Picture 4: Culvert Inlet



Picture 5: Looking Downstream



Picture 6: Hole at Outlet Waterline



Picture 7: Debris Jam After 2011 Flood Event

Appendix B: Town Map

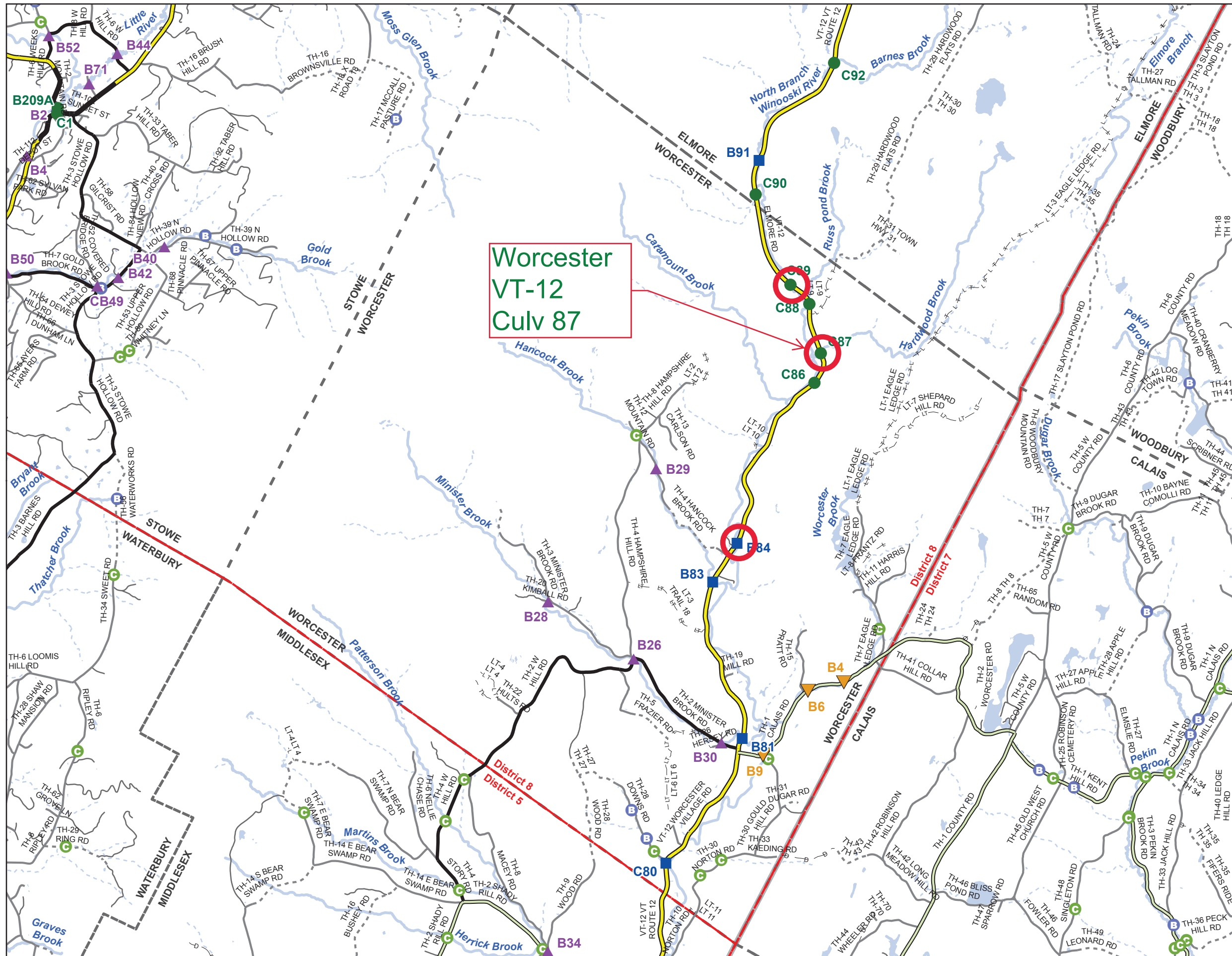

Worcester
VT-12
Culv 87

Scale: 1:60,330

- ★ INTERSTATE
- STATE LONG
- STATE SHORT
- ▲ TOWN LONG
- ▼ FAS/FAU
- ◆ BIKE PATH
- INTERSTATE
- STATE HIGHWAY
- CLASS 1
- CLASS 2
- CLASS 3
- - - CLASS 4
- - - LEGAL TRAIL
- PRIVATE
- - - DISCONTINUED
- FAS/FAU HWY
- - - MAINTENANCE DISTRICT
- - - POLITICAL BOUNDARY
- - - VTRANS REGION BOUNDARY
- NAMED RIVER-STREAM
- - - UNNAMED RIVER-STREAM
- B Point from Local Bridge Data *
- C Point from Local Culvert Data *

* Points are from local town bridge and culvert inventories. Some points may overlap where VTrans has also conducted an inventory on the Town highway.
Data source: VOBICIT aka VTCulverts

Produced by:
Mapping Section
Division of Policy, Planning and
Intermodal Development
Vermont Agency of Transportation
May 2017

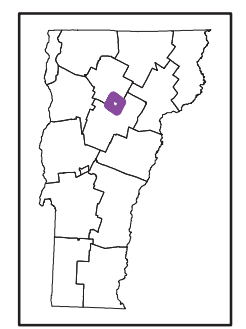

WORCESTER
COUNTY-TOWN CODE: 1220-0
WASHINGTON COUNTY
DISTRICT # 8
District Long Name: St. Albans District
VTrans Four Region: Northwest

This map was funded in part through grants from the Federal Highway Administration, U.S. Department of Transportation. The representation of the authors expressed herein do not necessarily state or reflect those of the U. S. Department of Transportation.

Appendix C: Bridge Inspection Report

STRUCTURE INSPECTION, INVENTORY and APPRAISAL SHEET

Vermont Agency of Transportation ~ Structures Section ~ Bridge Management and Inspection Unit

Inspection Report for **WORCESTER**

bridge no.: 0087

District: 8

Located on: VT12 over **HARDWOOD BROOK**

approximately 4.6 MI N SA I CALAIS R

Maintained By: STATE

CONDITION

Deck Rating: N NOT APPLICABLE
Superstructure Rating: N NOT APPLICABLE
Substructure Rating: N NOT APPLICABLE
Channel Rating: 5 FAIR
Culvert Rating: 5 FAIR
Federal Str. Number: 300241008712201

AGE and SERVICE

Year Built: 1961 Year Reconstructed: _____
Type of Service On: 1 HIGHWAY
Type of Service Under: 5 WATERWAY
Lanes On the Structure: 02
Lanes Under the Structure: 00
Bypass, Detour Length (miles): 4
ADT: 1000 Year of ADT: 1996

GEOMETRIC DATA

Length of Maximum Span (ft): 14
Structure Length (ft): 14
Lt Curb/Sidewalk Width (ft): 0
Rt Curb/Sidewalk Width (ft): 0
Bridge Rdwy Width Curb-to-Curb (ft): 0
Deck Width Out-to-Out (ft): 0
Appr. Roadway Width (ft): 29
Skew: 45
Bridge Median: 0 NO MEDIAN
Feature Under: FEATURE NOT A HIGHWAY OR RAILROAD
Min Vertical Underclr (ft): 08 FT 00 IN

STRUCTURE TYPE and MATERIALS

Bridge Type: CGMPPA
Number of Main Spans: 1
Kind of Material and/or Design: 3 STEEL
Deck Structure Type: N NOT APPLICABLE
Type of Wearing Surface: N NOT APPLICABLE
Type of Membrane: N NOT APPLICABLE
Deck Protection: N NOT APPLICABLE

CULVERT GEOMETRIC DATA and INDICATORS

Culvert Barrel Length (ft): 96
Average Cover Over Culvert (ft): 10
Waterway Area Through Culvert (sq.ft.): 93
Wingwall/Headwall Rating: 6 SATISFACTORY CONDITION

APPRAISAL

Appr. Rdwy. Alignment: 8 EQUAL TO DESIRABLE CRITERIA

INSPECTION

Inspection Date: 112016 Inspection Frequency (months): 60

INSPECTION SUMMARY and NEEDS

11/30/16 Barrel invert has deep pitting and just matter of time holes will be present. Large hole along south side at outlet end just outside of flow line and beneath haunch. Barrel should be considered for liner or concrete invert as shape is still fairly good. MJK JS

09/28/11 The pipe is in satisfactory condition with some heavy rust scale along the invert but no holes where found. DP & JM

Culvert is in fair condition. Deep pitting along the invert will eventually lead to pinholes. Holes at the southwest end should be patched. 07/13/06

Appendix D: Hydraulics Memo

**State of Vermont
Structures and Hydraulics Section**

One National Life Drive
Montpelier, Vermont 05633-5001
vtrans.vermont.gov

[phone] 802-371-7326
[fax] 802-828-3566
[ttd] 800-253-0191

Agency of Transportation

TO: Laura Stone, Structures, Scoping Engineer

CC: Nick Wark, Hydraulics Engineer

FROM: Jeff DeGraff, Hydraulics Project Engineer

DATE: June 2, 2020

SUBJECT: Worcester BF 0241(56) pin #19B213
Worcester, VT-12 Br87, over Hardwood Brook
Site location: MM 6.210
Coordinates: [44.4308296, -72.5336337](https://www.google.com/maps/place/44.4308296,-72.5336337)

We have completed our hydraulic study for the above referenced site, and offer the following for your use:

On 12/11/19 we met with ANR at the site. In an email on 12/12/19 they indicated a minimum span of 19-feet should be used to span bankfull width (BFW).

VT-12 is a Major Collector. Therefore, Design Storm Flow is 2% AEP (Q50).

The following options were analyzed:

Existing Conditions: 13'-11" x 8'-7" CGMPPA (Pipe Arch) Culvert (Existing Conditions)

- Provides a Headwater to Depth ratio (HW/D) of 0.85 and 0.97 during the design and check storm event, respectively.
- The existing culvert meets the current hydraulic standards

Option 1: Bridge (3-sided) 19-foot span x 7.0-foot clear rise

- There is approximately 1.95-feet and 1.13-ft of freeboard at the inlet and outlet, respectively, during the design AEP, providing a waterway area of 133.0 sq. ft.
- Does not increase the 100-year base flood elevations
- Assumes no changes to the existing structure alignment/skew

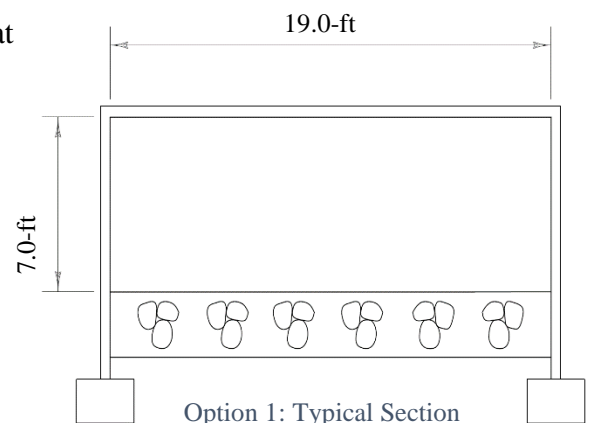

Option 2: Bridge (3-Sided) 19-foot span x 7.0-foot clear rise w/sloping fill

- There is approximately 1.87-feet and 1.13-ft of freeboard at the inlet and outlet, respectively, during the design AEP, providing a minimum waterway area of 131.5 sq. ft ±
- Does not increase the 100-year base flood elevations
- Assumes no changes to the existing structure alignment/skew

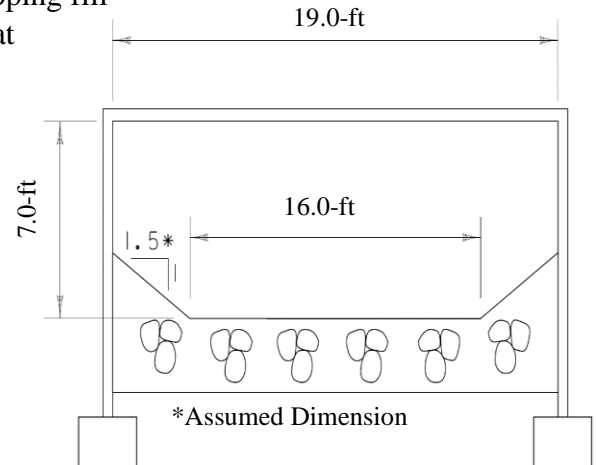

Option 2: Typical Section

Option 3: Four-Sided Concrete Box (closed bottom) 19-foot span x 10-foot rise

- There is approximately 1.95-feet and 1.13-ft of freeboard at the inlet and outlet, respectively, during the design AEP
- Structure invert is to be buried 3-feet and provide a minimum waterway opening of 19-foot span x 7-foot clear height with a waterway area of 133.0 sq. ft.
- Bed retention sills should be added in the bottom of the structure. Sills should be 12 inches high at the edges of the box and 6 inches high in the center, creating a V-shape across the full width of the box. Sills should be spaced no more than 8 feet apart throughout the structure with one sill placed at both the inlet and the outlet
- Does not increase the 100-year base flood elevations
- Assumes no changes to the existing structure alignment/skew

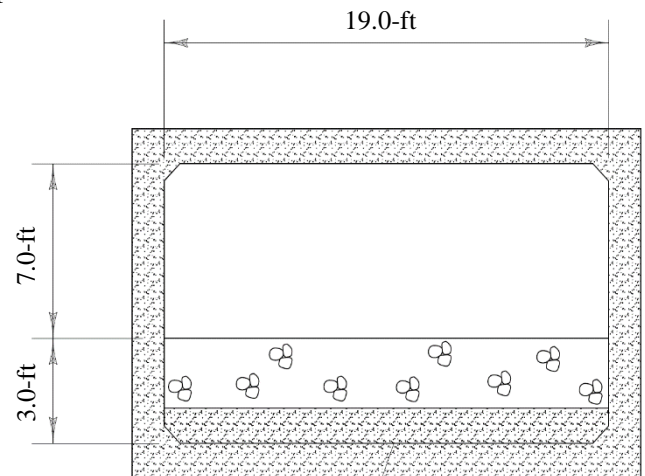

Option 3: Typical Section

The Existing Conditions meets current hydraulic standards but does not meet current environmental standards. For this reason, this option is not recommended.

This project is most likely to be replacement. A retrofit option may provide aquatic organism passage and may be considered during final if deemed a viable option. If this is the preferred option, further environmental coordination is recommended.

Options 1, 2 and 3 meet or surpass the current hydraulic standards, as well as minimum bankfull width criteria. The tailwater condition with a water surface elevation of 923.0 +/- is currently controlling the culvert rise to provide a minimum of 1-foot of freeboard during the design AEP. For these analyses, a culvert slope of 2% was assumed which may be adjusted during final design to decrease the rise and/or increase freeboard. In addition, for these options, E-Stone, Type III will need to be used to build the channel through respective structure and Stone Fill, Type III is to be used to protect any disturbed channel banks or roadway slopes at the structure's inlet and outlet. A final scour countermeasure design will be performed during final design.

A preliminary scour analysis was performed as part of this study for Options 1 and 2 assuming a D50 of 1mm. A preliminary scour depth of 2.0-ft was calculated. For preliminary design assume that the bottom of footing elevation is 6-ft below the streambed or founded on ledge. A final scour analysis will be performed during the final design phase.

Other similar sized structures could be considered for this site. If another alternative is considered, coordinate with the Hydraulics Unit to perform additional analyses.

Please contact us with any questions, or to check substructure configuration scenarios.

Appendix E: Preliminary Geotechnical Information

To: Nick Wark, P.E., P.I.I.T. Program Manager

END

CEE

From: Eric Denardo, P.E., Geotechnical Engineer, via Callie Ewald, P.E.

Date: December 11, 2019

Subject: Worcester BF 0241(56) - Preliminary Geotechnical Information

1.0 INTRODUCTION

We have completed our preliminary geotechnical investigation for the replacement of Bridge No. 87 on VT Route 12 located approximately 4.6 miles north of the intersection of VT Route 12 and State Aid Road 1 (Calais Road). The subject project consists of replacing or rehabilitating the existing culvert. The existing structure is a corrugated galvanized metal plate pipe arch culvert. The project is currently in the scoping phase. This review included the examination of as-built record plans, historical in-house bridge boring files, water well logs and hazardous site information on-file at the Agency of Natural Resources, published surficial and bedrock geologic maps, and observations made from previous inspections, and site photos.

2.0 SUBSURFACE INFORMATION

2.1 Published Geologic Data

Published data indicates that soils at the site generally consist of Glaciofluvial Pebbly Sand (Doll, 1970) underlain by the Pinstriped Granofels and Quartzite member of the Moretown Formation (Ratcliffe, et. al, 2011).

The Agency of Natural Resources (ANR) documents and publishes all water wells that are drilled for residential or commercial purposes. Published online, these logs may provide general characteristics of the soil strata in the area. No water wells were located within an approximate 500-foot (ft) radius of the project. The closest well was located approximately 1350 feet south of the culvert. Bedrock was reported on the well report at a depth of 30 feet.

The Geotechnical Engineering Section maintains a GIS based historical record of subsurface investigations, which contains electronic records for the majority of borings completed in the past 10 years. An exploration of this database revealed no projects within a half mile radius.

2.2 Hazardous Materials and Underground Storage Tanks

The ANR Natural Resource Atlas also maps the location and information of known hazardous waste sites and underground storage tanks. The location of this project is not on the Hazardous Site List and no hazardous sites or underground storage tanks were identified in a 1-mile radius of the culvert.

2.3 Record Plans

An investigation into records plans for the construction of the culvert was also a part of this research. Record plans were available from the original construction of the culvert in 1961 however, the plans did not include any borings or subsurface information.

3.0 FIELD OBSERVATIONS

A site investigation was not conducted by Geotechnical Section staff for this project; however, photos from a site visit done by the Structures Section, bridge inspection photos, and satellite imagery were reviewed to evaluate feasibility of boring operations and assess general site conditions as they relate to the proposed project.

Overhead utilities run parallel with VT 12 on the eastern side of the roadway above the culvert. The utilities can be seen in Figure 3.1. A minimum safe distance from the drilling equipment will be required to be maintained during drilling operations and should be considered during the planning of any subsurface investigation. The side slopes in the area of the culvert appear to be steep for this reason, borings for the inlet and outlet will likely need to be performed in the roadway. There is also some sloughing of the side slope south of the culvert in the area of the outlet. This can be seen in Figure 3.2. There are two rock cuts on the eastern side of VT 12 north and south of the culvert indicating there may be shallow bedrock at the project site. The rock cuts north and south of the culvert can be seen in Figures 3.3 and 3.4, respectively.



Figure 3.1: *Overhead utilities above culvert along VT 12. [Structures photo dated May 2019]*



Figure 3.2: *Sloughing of slope near the outlet. [Structures photo dated May 2019]*



Figure 3.3: Ledge cut north of the culvert. [Structures photo dated May 2019]



Figure 3.4: Ledge cut located south of the culvert. [Structures photo dated May 2019]

Appendix F: Resource ID Completion Memo



OFFICE MEMORANDUM
AOT - PDB - ENVIRONMENTAL SECTION

RESOURCE IDENTIFICATION COMPLETION MEMO

TO: Laura Stone, Project Manager
FROM: Jeff Ramsey, Environmental Specialist Supervisor
DATE: 11/20/19
Project: Worcester BF 0241 (56)

ENVIRONMENTAL RESOURCES:

- Archaeological Site: Yes X No See Archaeological Resource ID Memo
Historic/Historic District: X Yes No See Historic Resource ID Memo
Wetlands: X Yes No See Natural Resource Assessment Report
Agricultural Land: X Yes No See Natural Resource Assessment Report
Fish & Wildlife Habitat: X Yes No See Natural Resource Assessment Report
Wildlife Habitat Connectivity: X Yes No See Natural Resource Assessment Report
Endangered Species: X Yes No See Natural Resource Assessment Report
Stormwater: Yes X No
6(f) Property: Yes X No
Hazardous Waste/
ANR Urban Background Soils: Yes X No
USDA-Forest Service Lands: Yes X No
Scenic Highway/ Byway: Yes X No
Act 250 Permits: Yes X No
FEMA Floodplains: Yes X No
Flood Hazard Area/
River Corridor: X Yes No mapped river corridor, may need a FHARC permit
US Coast Guard: Yes X No
Lakes and Ponds: Yes X No
303D List/ Class A Water/
Outstanding Resource Water: Yes X No
Surface and Ground Water
(SPA) Source Protection Area: Yes X No
Groundwater Classification: Yes X No
Public Water Sources/
Private Wells: Yes X No
Other: X Yes No See Natural Resource Assessment Report

cc:
Project File

Appendix G: Natural Resources Memo

**Natural Resources Assessment Report for
Vermont Agency of Transportation
Worcester BF 0241 (56)**

Worcester, Vermont

*Prepared by:
Arrowwood Environmental, LLC*

October 18, 2019



ARROWWOOD ENVIRONMENTAL

950 BERT WHITE ROAD
HUNTINGTON, VT 05462
(802) 434-7276 FAX: (802) 329-2253

**Natural Resources Assessment Report for
Vermont Agency of Transportation
Worcester BF 0241 (56)**

Table of Contents

	Page #
I. Introduction and Project Description	2
II. Site Characterization	2
III. Wetlands	3
IV. Rare, Threatened and Endangered Species.....	3
V. Non-Native Invasive Species (NNIS)	5
VI. Streams	6
VII. Wildlife Habitat and Habitat Connectivity	6
VIII. Agricultural Soils	8

Appendices

- Appendix 1: Photo Log
- Appendix 2: Resource Map
- Appendix 3: Wetland Delineation Forms
- Appendix 4: Wetland Function and Value Forms
- Appendix 5: Rare Plant Reporting Form
- Appendix 6: Plant Species List
- Appendix 7: Stream Summary Forms

**Natural Resources Assessment Report for
Vermont Agency of Transportation
Worcester BF 0241 (56)**

I. Introduction and Project Description

Arrowwood Environmental, LLC (AE) was retained by the Vermont Agency of Transportation to perform a natural resources assessment for the proposed Culvert 87 project at mile marker 6.3 along Route 12 in Worcester, Vermont. The study area for the assessment is shown in Appendix 2 on the Resource Map.

The assessment consisted of a remote landscape analysis of the study area as well as a field assessment. The field assessment was conducted on September 10, September 13, September 16, and October 3, 2019. This Natural Resource Assessment Report summarizes the results of the remote analysis and field assessment.

II. Site Characterization

Ecologically the site is within the Northern Green Mountains biophysical region of the state (Thompson and Sorenson, 2000). The study area is located at approximately 935 feet above mean sea level according to U.S. Geologic Survey (“USGS”) topographic data. The mapped bedrock that is underlying the site is granofels and quartzite from the Moretown Formation. (Ratcliffe et al. 2011). The soils are mapped as Rumney and Machias soils which are fine sandy loams (NRCS Soil Survey). The surrounding landscape is dominated by forest land and low density rural residential development.

Much of the study area consists of mowed roadside dominated by herbaceous vegetation. The upland forests in the study area consist of Hemlock-Northern Hardwood forests and Northern Hardwood Forests. Two wetland complexes (described below) are also present within the study area.

III. Wetlands

The wetland assessment involved both a remote review of available maps (including Vermont Significant Wetland Inventory Maps and the NRCS Soil Survey) and a field inventory component conducted on September 10 and October 3, 2019. The protocols put forth in the USACE's *Corp of Engineers Wetlands Delineation Manual* (2009 Regional Supplement for the Northcentral and Northeast Region) were employed for delineating wetlands as is the standard practice in Vermont. Two wetland complexes were mapped within the study area and are shown on the Resource Map in Appendix 2. Wetland classifications have not been determined with the Vermont Wetlands Office. Wetland delineation data forms and functions and values assessments for each of these wetlands are included in Appendices 3 and 4, respectively.

Wetland A/B: Wetland A/B is characterized as an Alluvial Shrub Swamp complex that flanks both banks of Hardwood Brook on the north side of Route 12. Wetland vegetation is dominated by shrub species (*Salix spp*) and wetland soils are characterized by frequently flooded silt loams. The wetland extends along the brook and out of the study area to the north east. The wetland is not contiguous with a mapped VSWI Class 2 wetland but is presumed to be Class 2 due to its size and association with Hardwood Brook.

Wetland C/D: Wetland C/D is also characterized as an Alluvial Shrub Swamp that flanks both banks of Hardwood Brook on the south side of Route 12. Wetland vegetation is dominated by shrub species (*Salix spp*) and wetland soils are characterized by frequently flooded silt loams. The wetland complex extends along the stream to the west and is contiguous with a mapped VSWI Class 2 wetland and is therefore presumed to be Class 2.

IV. Rare, Threatened and Endangered Species

The RTE species review involved both a remote review of available digital maps for the study area as well as a field survey. AE reviewed digital orthophotography, the NRCS Soil Survey, the 2011 Bedrock Geologic Map of Vermont and the Natural Heritage Inventory (NHI) Rare, Threatened and Endangered Species digital database.

In reviewing the NHI digital database, there are no records or occurrences of RTE plant species in or directly adjacent to the study area.

Plant Species

An inventory for RTE and uncommon plant species was undertaken in the study area on September 13, 2019. An S1 ranked species and three S3 ranked species were documented within the study area and are shown on the attached Resource Map. A complete list of plants documented during that inventory is presented in Appendix 6.

Three populations of Carey's smartweed (*Persicaria careyi*) (S1) were identified and mapped. Population 1 had 52 genets, Population 2 had 12 genets and Population 3 had 2 genets. These may be the only known extant populations in the State of Vermont. One population of musk flower (*Erythranthe moschatus*) (S3) was identified with 2 genets. Three populations of ovate spike-rush (*Eleocharis ovata*) (S3) were identified with Population 5 having 18 genets, Population 6 having 5 genets, and Population 7 having 12 genets. The population of musk flower (Population 4) and Populations 5 and 6 of the ovate spike-rush all overlap the large Population 1 of Carey's smartweed. These species are all primarily in exposed sandy/silty bars or flats along the stream, where it has a broader wet meadow floodplain. The musk flower is just 2 tiny plants, barely established this year, and may not persist.

One population of clammy everlasting (*Pseudognaphalium macounii*) (S3) was identified on the south side of Route 12 on the road embankment. This population had 23 genets.

Carey's smartweed, ovate spike-rush and clammy everlasting are annuals or biennials, so seed collection might be an acceptable mitigation step if impacts to the plants cannot be avoided.

A Rare Plant Reporting Form for *Persicaria careyi* is included in Appendix 5.

Animal Species

The Northern Long Eared Bat (*Myotis septentrionalis*, MYSE) became a federally listed endangered species in May of 2015. The State of Vermont has determined that project clearing greater than 1% of the total forested area within a 1 square mile radius of a project triggers greater review for habitat loss for this endangered species. Although the specific details of the proposed project at this location are unknown, it is located in an extensively forested environment with approximately 1700 acres of forest within a 1 mile radius. The Project would require more than 17 acres of clearing before reaching the 1% threshold triggering MYSE related restrictions or further review.

The study area was reviewed for the presence of trees that may provide potential summer roost habitat for MYSE. Seven trees with features that could support MYSE roosting were documented during the field investigation. Although project clearing is unlikely to trigger MYSE related restrictions or further review, the preservation of these potential roost trees would help insure avoidance of any impacts to MYSE.

According to the NHI database, there is a record for the S3 ranked wood turtle in the project area. One female was documented in 2005 along a 1.2 mile stretch of the tributary of the North Branch that runs through the study area. No *de novo* surveys for this species were conducted for this study; during the summer, wood turtles are generally foraging away from the stream and are difficult to detect. Wood turtles rely on stream and stream-side habitats (especially associated wetlands) during the fall, winter and spring for breeding, hibernation, foraging and basking. Since bridge abutments often create favorable overwintering sites, work conducted during a period of July – September would help to avoid impacts to individuals that may be congregating in the study area for that purpose.

V. Non-Native Invasive Species (NNIS)

A non-native invasive plant species is considered to be a species which has become established outside of its native range and grows aggressively enough to threaten native ecological communities. For the purposes of this study, a NNIS plant is any species listed as a Class A or Class B noxious weed by the Vermont Noxious Weed Quarantine Rule or a plant on the Vermont Invasive Exotic Plant Committee Watch List. An inventory for non-native invasive plant species was conducted on September 16, 2019.

Two NNIS species comprising four populations were mapped in the study area and are described below.

Morrow's honeysuckle (*Lonicera morrowii*): Two populations of Morrow's honeysuckle were identified and mapped. Population N1 comprises 30% cover of the embankment. Population N2 consists of a single sprout.

Reed Canary Grass (*Phalaris arundinacea*): Two populations of Reed Canary Grass were identified and mapped on the west side of Route 12. Population N3 is located within wetland C and comprises 10-50% cover mix to the edge of the stream. Population N4 is to the north of wetland D and adjacent to Route 12 and consists of 18 plants.

VI. Streams

The stream assessment involved both a remote review of the USGS topographic map, Vermont Hydrography Dataset (streams, rivers, and waterbodies), LiDAR derived elevation data, and field investigation on September 10, 2019. One stream was mapped in the study area and is summarized below. A stream data form is provided in Appendix 7.

Hardwood Brook: Culvert 87 crosses Hardwood Brook. The brook is characterized as a perennial stream with predominately coarse gravel substrate. The estimated bankfull channel width ranges from 15-20' wide upstream of the structure. The banks of the brook are rip rapped upstream of the undersized structure and a large scour pool is present downstream of the structure.

VII. Wildlife Habitat and Habitat Connectivity

The wildlife habitat assessment involved both a remote review of available digital maps for the study area and a field inventory component. A remote review of available digital databases was conducted to identify potentially necessary wildlife habitat within the study area and within the vicinity of the study area.

There are mapped Vt. Fish and Wildlife deer winter area (DWA) habitats in the study area. Field investigation confirmed the presence of deer browse activity at the edge of the mapped DWA east of the structure, but the structural forest components of deer winter habitat are not present close to the road within the study area.

Vt. Fish and Wildlife identifies the study area as a Highest Priority wildlife crossing and Highest Priority surface water and riparian area in the Vt. Conservation Design Community and Species Scale Components. The forest surrounding the study area is unfragmented with varying habitat types and considerable compositional and structural diversity. The roadway cuts tightly through

the surrounding forest with only minor elevation changes between road edge and forest and presents no significant barriers to habitat connectivity. The stream corridor at this crossing provides a link between a large wetland complex and forest to the east and the North Branch Winooski River to the west, but quality crossing opportunities are ample on the surrounding landscape. Bear crossings have historically been noted within the study area, and there are records of moose collisions nearby. The squashed culvert itself is configured such that it provides some terrestrial connectivity opportunity, especially in lower flows with a wide, flat bottom. The wide and deep outlet pool may limit the appeal of the stream channel itself for focused east/west travel during much of the year, however during frozen conditions it is likely an important connection that offers protected and safe movement under the road for terrestrial wildlife and riparian associated species such as mink and otter. Due to the large outlet pool, the culvert outflow may be perched only in very low flows, but regardless the structure is well above the streambed at the outlet and no natural substrate is present within the structure both of which limit its function for aquatic organism passage. Any new structure design should carefully consider both terrestrial and aquatic passage at this location.

Concentrated amphibian crossing areas occur when different amphibian habitat features are separated from each other by roads. Typical habitat features include wetland/vernal pool breeding habitats and upland habitats, or, in some cases, different wetland feeding habitats. Movement typically occurs on warm rainy nights in the spring and early summer. Depending on surrounding land-use and the position of the different habitat features, this amphibian movement can be concentrated and involve hundreds or thousands of individuals. When this concentrated movement occurs across a busy road, mass mortality of amphibians can occur. While minor amphibian movement can occur scattered across the landscape, this movement rarely results in mass amphibian mortality or traffic difficulties. For this reason, it is the concentrated amphibian crossing areas that are of a concern.

The Alluvial Shrub Swamp wetlands identified in the project area provide habitat for amphibians with pockets and pools of open water to the northeast of the structure and throughout the wetland to the east. lack open water areas. Stream salamanders are likely present in the study area along the brook and wetlands mapped. Based on the habitats present, these species likely include spring salamanders (*Gyrinophilus porphyriticus*), northern dusky salamanders (*Desmognathus fuscus*)

and northern two-lined salamanders (*Eurycea bislineata*). For these species only limited movement occurs outside of the stream corridor and mass migrations do not occur. Since these species rarely cross roads, they do not pose a management concern as concentrated amphibian crossing areas. However, since they do migrate within the stream corridor, management for these species at road crossings is best achieved by adhering to the AOP Guidelines for culvert and bridge construction.

VIII. Agricultural Soils

The agricultural soils assessment involved a remote review of the NRCS County Soil Survey for the Project area. Primary agricultural soils were identified in the Project area and presented on the attached Resource Map. Primary soil types present include Rumney (Statewide (b)) and Machias (Statewide (b)) fine sandy loams. These soil types are frequently flooded but not considered highly erodible.

Appendix 1

Photo Log



Culvert 87:Downstream pool
September 10, 2019



Wetland A/B Alluvial Shrub
Swamp September 10, 2019



Wetland C/D Alluvial Shrub
Swamp September 10, 2019

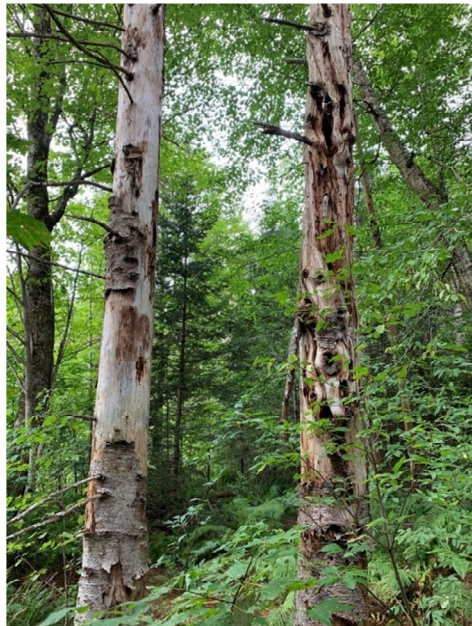

Potential Bat Roost Trees
September 10, 2019



Carey's smartweed
(*Persicaria careyi* (S3))
September 13, 2019

Appendix 2

Resource Map

Id	RTE/U Species	S-Rank	Population Size
1	Persicaria careyi	S1	52 genets
2	Persicaria careyi	S1	12 genets
3	Persicaria careyi	S1	2 genets
4	Erythranthe moschatus	S3	2 genets
5	Eleocharis ovata	S3	18 genets
6	Eleocharis ovata	S3	5 genets
7	Eleocharis ovata	S3	12 Genets
8	Pseudognaphalium macounii	S3	23 genets

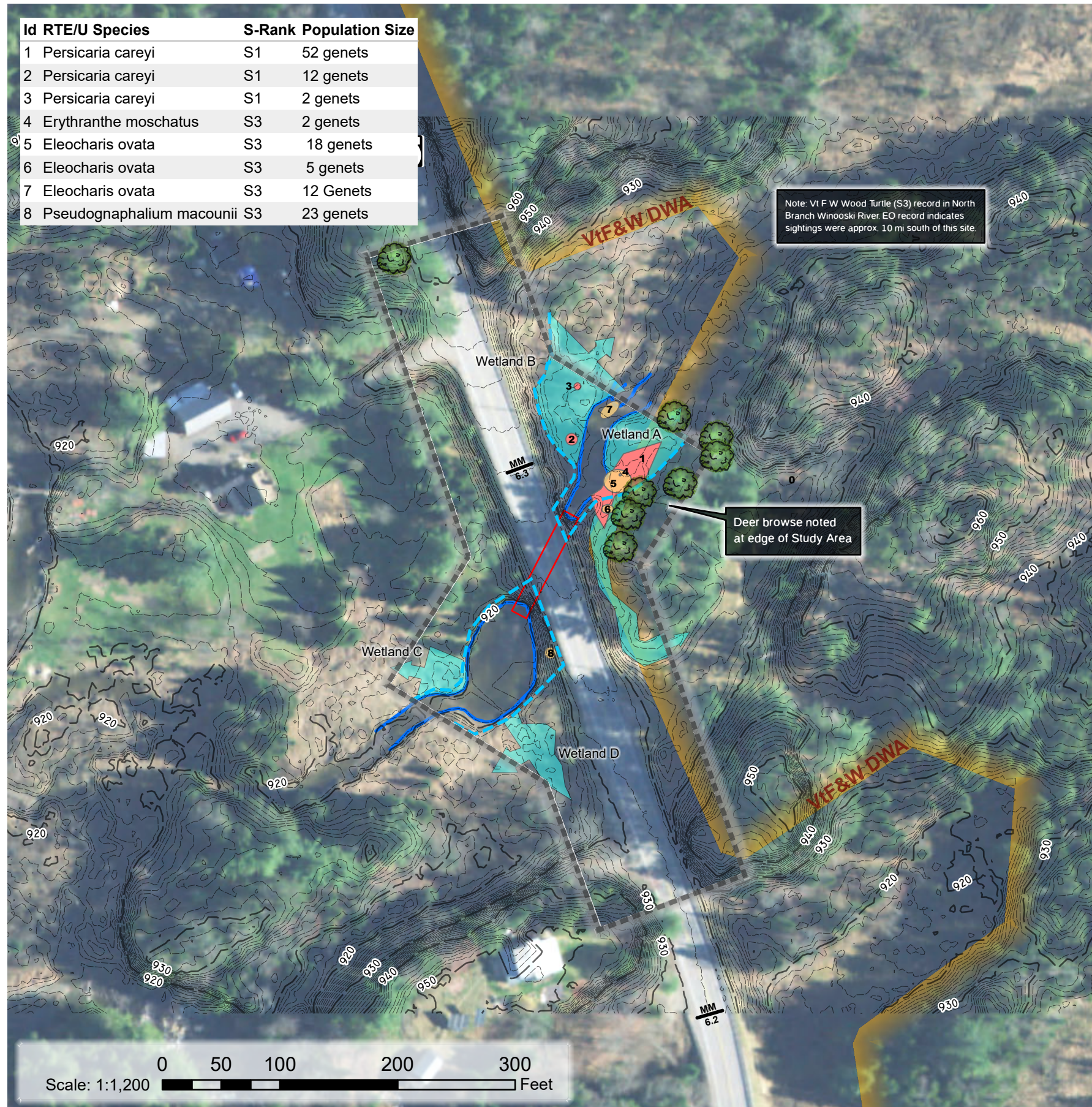

Non-native Invasive Species (NNIS)

Prime Ag Soils: Statewide Ag Soils:

NNIS Populations at this Site

NNIS ID	Species
N-1	Lonicera morrowii
N-2	Lonicera morrowii
N-3	Phalaris arundinacea
N-4	Phalaris arundinacea

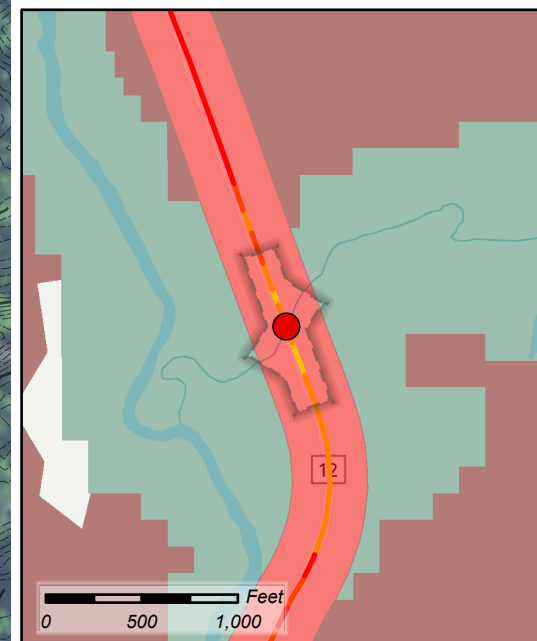
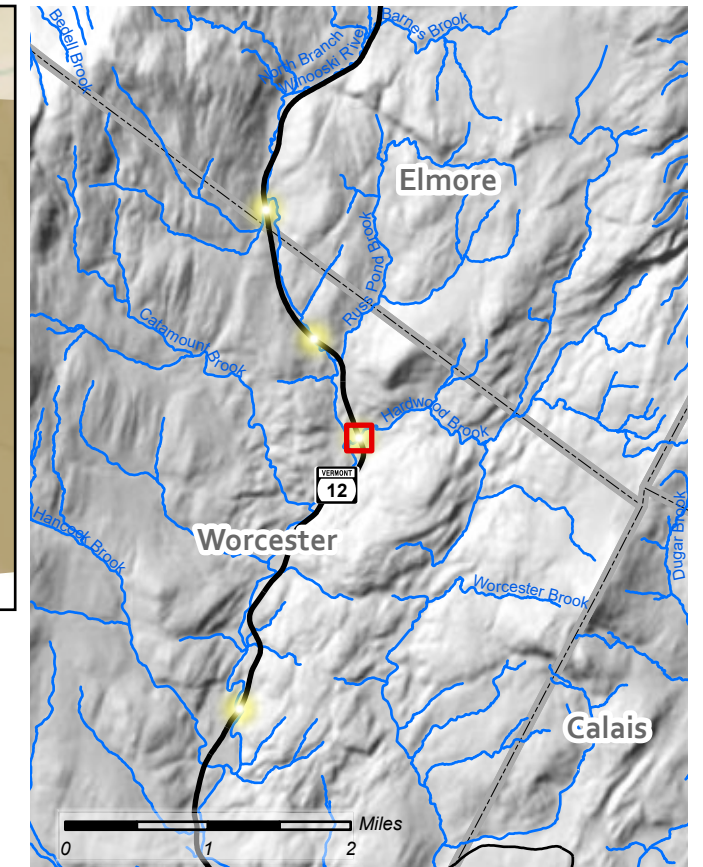

Vt. Conservation Design Elements

- Highest Priority Wildlife Crossings
- Highest Priority Surface Water and Riparian Areas
- Highest Priority Interior Forest Blocks

Combined Linkage Ratings

◀ not imp. more imp. ▶

- Mile Markers (VCGI)
- ▭ Study Area
- ▭ Structures
- ▭ Wetlands
- Stream or Edge of Water
- - - Stream Top-of-Bank
- ▭ RTE Plant: S1
- ▭ Uncommon Plant: S3
- 🌳 Potential Bat Tree
- ▭ Deer Winter Areas (Vt F&W)

NOTES: INFORMATION PROVIDED BASED ON REMOTE AND FIELD ASSESSMENT BY ARROWWOOD ENVIRONMENTAL, 2019. WETLANDS FIELD DELINEATED, FLAGGED AND FLAGS LOCATED WITH SUB-METER GRADE GPS BY ARROWWOOD ENVIRONMENTAL. STREAMS, TOP-OF BANK, PLANT POPULATIONS, WILDLIFE FEATURES, AND STRUCTURE LOCATIONS FROM SUB-METER GRADE GPS, FIELDNOTES, AND ANALYSIS OF AERIAL IMAGERY AND HIGH-RESOLUTION LIDAR TOPOGRAPHIC DATA.

OTHER DATA FROM VCGI, VT AGENCY OF NATURAL RESOURCES. CONTOUR INTERVAL 1' DERIVED FROM LIDAR-BASED ELEVATION MODELS PROVIDED BY VCGI. MILE MARKERS FROM VCGI LAYER TITLED: "VT_MILE_POINTS_110MILE". BACKGROUND IMAGERY- VCGI 2018.



Appendix H: Archeology Memo

Jeannine Russell
VTrans Archaeology Officer
State of Vermont
Environmental Section
One National Life Drive
Montpelier, VT 05633-5001
802-477-3460 phone
Jeannine.russell@vermont.gov

Agency of Transportation

To: Jeff Ramsey, Environmental Specialist Supervisor

From: Jeannine Russell, VTrans Archaeology Officer via Timothy Quesnell, VTrans Archaeology Apprentice II

Date: October 24, 2019

Subject: Worcester BF 0241(56) – Archaeological Resource ID

VTrans proposes work on a culvert in the town of Worcester located on Vermont Route 12. The current scope and boundaries of the project are unknown. A circle with the bridge sitting at the center has been used for a stand in project area on the map provided. The VTrans Archaeology Apprentice were able to conduct a field visit on September 27th, 2019.

The project area is located about a mile and a half south of the Worcester/Elmore town border. Hardwood Brook runs westward through the culvert and exits into a small pond bordering the road. The creek then runs further westward and converges with the North Branch Winooski River 160 meters southwest of the culvert. Between the drainage pond outside the culvert and the intersection of the stream and river begins a large wetland that runs northward along the Winooski River. The area making up the four quads around the culvert are mostly flat. The west quadrants appear undisturbed and to be composed of flooded soils, due to the presence of the wetland and its proximity to the brook. The east quadrants have been disturbed by the insertion of flat landform made of boulders, laid over with straw. The area appears to be parking for a trail head, with the trail entrance demarked by two carved branches sticking out of the ground.

There are no known sites nearby. Using the environmental predictive model, a score of 30 was found for this location, determined by the stream running through the culvert, the neighboring wetland and the nearby intersection of the stream and the Winooski River. The score of the model indicates moderate sensitivity. However, due to the wetland soils in the west quadrants and the disturbance in the east, there is overall low sensitivity for precontact resources. Looking at historic resources, a saw mill was found to be near the project area, where the creek and river intersect, on the Beers map. The field visit taken by the archaeology apprentice was unable to find the remaining foundation of this mill. Additionally, given that the Beers map placed the mill at the stream/river intersection, any remains of the mill not observed should be outside the area of potential effect for this culvert project.

The land within this project area has low sensitivity for cultural resources. The project area is flat and in proximity to a major river, but the presence of wetlands and disturbed soils leaves few areas ideal for preservation.

Please let me know if you have any questions.

Thank you,
Jen Russell
VTrans Archaeology Officer

Figure 1: Project Location

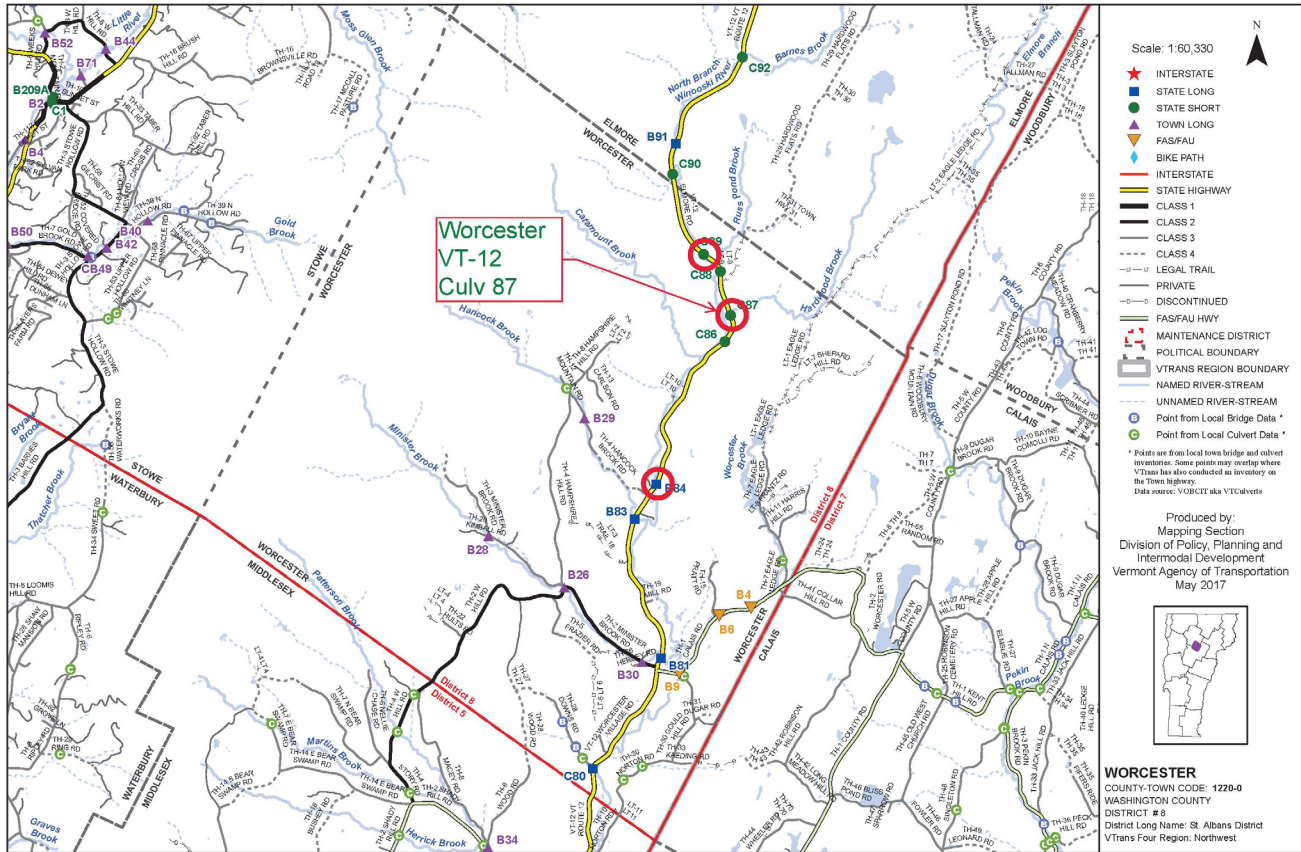

Figure 2: ARA Map

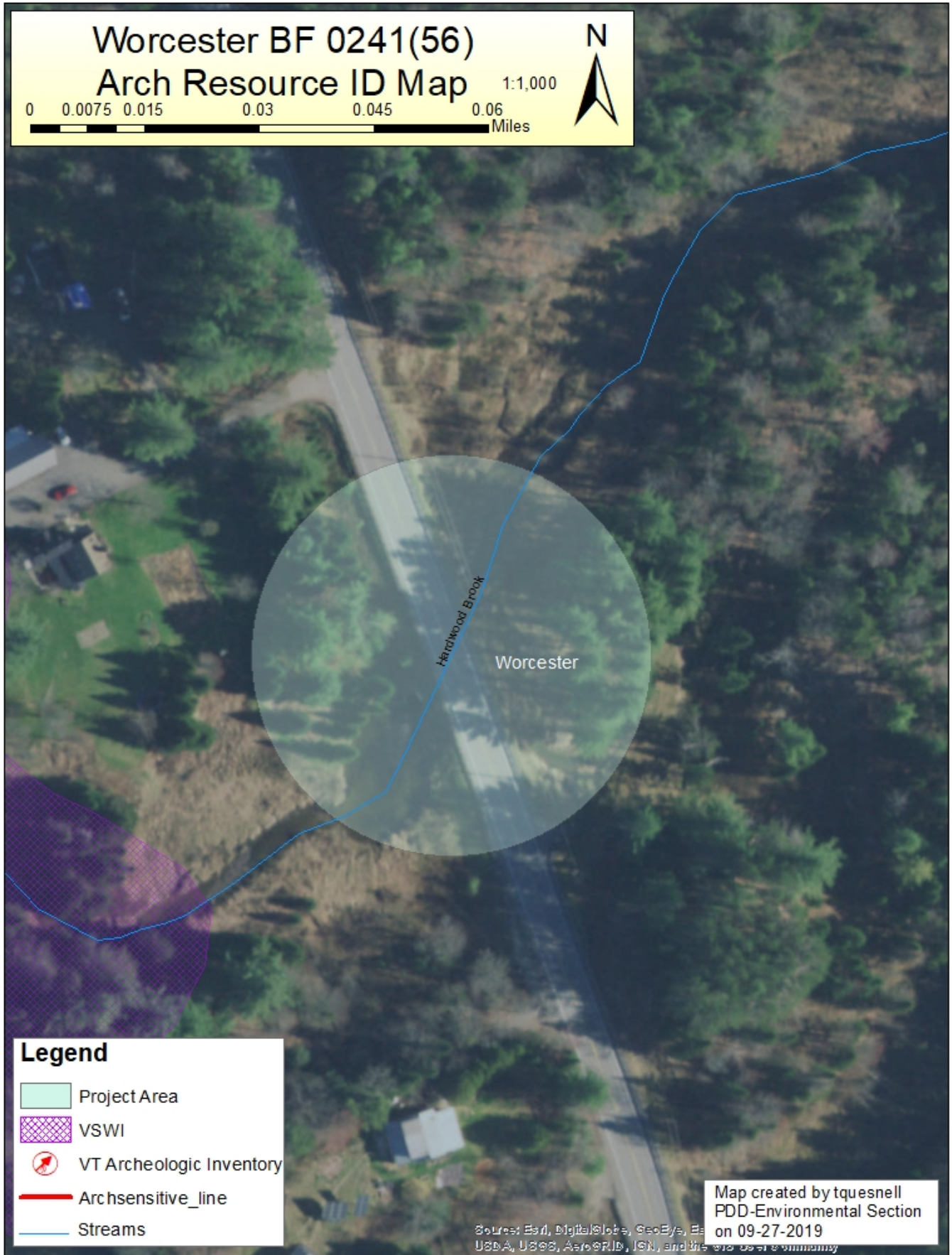

Figure 3: Flooded soils to the west of the culvert



Figure 4: Culvert from east side of road



Figure 5: Boulders laid over ground with straw placed over them, east of culvert



Figure 6: Two branches marking start of trailhead, east of culvert



Appendix I: Historic Memo

State of Vermont

Agency of Transportation

Gabrielle Fernandez
AOT Technical Apprentice IV
Gabrielle.Fernandez@vermont.gov
(802) 793-3738

Project Delivery Bureau - Environmental Section
One National Life Drive
Montpelier, VT 05633-5001
vtrans.vermont.gov

Historic Resources Identification Memo

To: Jeff Ramsey, AOT Environmental Specialist
CC: Jeannine Russell, AOT Archaeology Officer
Reviewer: Judith Ehrlich, AOT Historic Preservation Officer

Date: November 20, 2019

Subject: Worcester BF 0241(56) 19B213

I have completed the Resource Identification for Worcester BF 0241(56). At this time, three properties over fifty years of age were identified within the possible project area: culvert 87, a residence at 980 Elmore Road, and a residence at 962 Elmore Road in Worcester. No additional 4(f) resources were identified within the survey area.

This Resource Identification effort is being undertaken to provide information to the VTrans designers working on a proposed improvement project on culvert 87 in Worcester (Figure 1). Toward that end, VTrans Cultural Resources staff have identified potential resources within a broad preliminary Area of Potential Effect to ensure the designers are aware of all cultural resources that could possibly be affected by a project. Once the project is defined at the Conceptual Design phase, Cultural Resources staff will be able to determine a formal Area of Potential Effect for purposes of Section 106, 22 VSA § 14, and Section 4(f) responsibilities.

Culvert 87 is a metal culvert over the Hardwood Brook on VT 12 in Worcester (Figures 2 and 3). Built in 1961, this culvert meets the 50-year criteria for eligibility for the National Register. However, because of the condition of the culvert and the fact that it displays common materials, design, and construction, VTrans has determined that it is not historic as it does not possess any qualities of significance necessary for inclusion in the National Register of Historic Places individually or as a contributing resource to an existing or potential historic district under any applicable evaluation criteria.

Two additional properties were identified at 980 and 962 Elmore Road in Worcester. Both buildings are two story homes set back from the road with gable roofs. Stylistically, they have had changes over the years, yet they contribute to the character of the buildings. A Walling's map from the 1850s indicates a building at the location of both residences (Figure 4). Further deed research would be required to confirm they were the same homes, however at present

VTrans can say that these buildings are historic and retain enough significance and integrity to be eligible for the National Register under Criterion A – representative samples of the milling industry that was once prevalent in the area.

Please do not hesitate to contact me should you have any questions.

Attachments:

- Map
- Photos



Figure 1: Google Earth view of the approximate survey area for Worcester BF 0241(56).



Figure 2: Culvert 87 in Worcester.



Figure 3: Google Maps view of the survey area and culvert 87.



Figure 4: 1850s Walling's map of the culvert area and adjacent identified historic resources.

Appendix J: Hazardous Sites Map



LEGEND

- Landfills**
 - OPERATING
 - CLOSED
- Land Use Restrictions**
 - Class IV GW Reclass
 - Class VI GW Reclass
 - Deed Restriction
 - Easement
 - Land Record Notice
 - Other
- Hazardous Site
- Hazardous Waste Generators
- Brownfields
- Salvage Yard
- Aboveground Storage Tank
- Underground Storage Tank (w/...)
- Dry Cleaner
- Urban Soil Background Areas
- Roads**
 - Interstate
 - Principal Arterial
 - Minor Arterial
 - Major Collector
 - Minor Collector
 - Local
 - Not part of function Classification S
- Waterbody

1: 10,757
August 21, 2019

546.0 0 273.00 546.0 Meters

WGS_1984_Web_Mercator_Auxiliary_Sphere 1" = 896 Ft. 1cm = 108 Meters
© Vermont Agency of Natural Resources THIS MAP IS NOT TO BE USED FOR NAVIGATION

DISCLAIMER: This map is for general reference only. Data layers that appear on this map may or may not be accurate, current, or otherwise reliable. ANR and the State of Vermont make no representations of any kind, including but not limited to, the warranties of merchantability, or fitness for a particular use, nor are any such warranties to be implied with respect to the data on this map.

NOTES

Map created using ANR's Natural Resources Atlas

Appendix K: Local Input

Local & Regional Input Questionnaire

Project Summary

This project, BF 0241(56), focuses on culvert 87 on VT Route 12 in Worcester, Vermont. The culvert is deteriorating and is in need of either a major maintenance action or replacement. Potential options being considered for this project include a liner of the existing culvert, or a replacement of the structure. It is possible that VTrans will recommend a road closure and detour traffic away from the project site for the duration of the work. Efforts will be made to limit the detour to State roads.

Community Considerations

1. Are there regularly scheduled public events in the community that will generate increased traffic (e.g. vehicular, bicycles and/or pedestrians), or may be difficult to stage if the culvert is closed during construction? Examples include annual bike races, festivals, parades, cultural events, weekly farmers market, concerts, etc. that could be impacted? If yes, please provide approximate date, location and event organizers' contact info.
4th of July. Thursday, June thru September- Farmer's Market.
2. Is there a "slow season" or period of time from May through October where traffic is less or no events are scheduled?

May-August

3. Please describe the location of the Town garage, emergency responders (fire, police, ambulance) and emergency response routes that might be affected by the closure of the culvert, one-way traffic, or lane closures and provide contact information (names, address, email addresses, and phone numbers).

Brian Powers, brianpowers68@comcast.net 223-6942 11 Maxham Dr. is the highway dept: Will Sutton, wsznbvt@comcast.net 802-557-1037 20 Worcester Village Rd is the location of the fire dept.; Rt 12 is the only access for fire and rescue to reach homes north on Rt12. Highway is responsible to plow side roads only accessible from Rt12.
4. Are there businesses (including agricultural operations and industrial parks) or delivery services (fuel or goods) that would be adversely impacted either by a detour or due to work zone proximity?

Yes, Rt12 is the only access to many homes.

5. Are there important public buildings (town hall, community center, senior center, library) or community facilities (recreational fields, town green, etc.) close to the project?

No

6. What other municipal operations could be adversely affected by a road/culvert closure or detour?

Schools

7. Are there any town highways that might be adversely impacted by traffic bypassing the construction on other local roads? Please indicate which roads may be affected and their

Local & Regional Input Questionnaire

condition (paved/unpaved, narrow, weight-limited culverts, etc), including those that may be or go into other towns.

Calais Rd-paved/gravel

8. Is there a local business association, chamber of commerce, regional development corporation, or other downtown group that we should be working with? If known, please provide name, organization, email, and phone number.

No

9. Are there any public transit services or stops that use the culvert or transit routes in the vicinity that may be affected if they become the detour route?

No

Schools

1. Where are the schools in your community and what are their yearly schedules (example: first week in September to third week in June)?

South of Bridge on Calais Rd – August thru June

2. Is this project on specific routes that school buses or students use to walk to and from school?

Yes

3. Are there recreational facilities associated with the schools nearby (other than at the school)?

Yes-Ladd Field

Pedestrians and Bicyclists

1. What is the current level of bicycle and pedestrian use on the culvert?

Heavy Bicycle/pedestrian

2. Are the current lane and shoulder widths adequate for pedestrian and bicycle use?

No

3. Does the community feel there is a need for a sidewalk or bike lane on the culvert?

Yes

4. Is pedestrian and bicycle traffic heavy enough that it should be accommodated during construction?

Yes

5. Does the Town have plans to construct either pedestrian or bicycle facilities leading up to the culvert? Please provide any planning documents demonstrating this (scoping study, master plan, corridor study, town or regional plan).

No

Local & Regional Input Questionnaire

6. In the vicinity of the culvert, is there a land use pattern, existing generators of pedestrian and/or bicycle traffic, or zoning that will support development that is likely to lead to significant levels of walking and bicycling?

No

Design Considerations

1. Are there any concerns with the alignment of the existing road? For example, if the culvert is located on a curve, has this created any problems that we should be aware of?

Width is a problem

2. Are there any concerns with the width of the road over the existing culvert?

Yes-too narrow

3. Are there any special aesthetic considerations we should be aware of?

No

4. Does the location have a history of flooding? If yes, please explain.

No

5. Are there any known Hazardous Material Sites near the project site?

No

6. Are there any known historic, archeological and/or other environmental resource issues near the project site?

Unknown

7. Are there any utilities (water, sewer, communications, power) buried with the existing culvert? Please provide any available documentation.

Unknown

8. Are there any existing, pending, or planned municipal utility projects (communications, lighting, drainage, water, wastewater, etc.) near the project that should be considered?

No

9. Are there any other issues that are important for us to understand and consider?

Houses close to bridge

Land Use & Zoning

1. Please provide a copy of your existing and future land use map or zoning map, if applicable.

N/A

Local & Regional Input Questionnaire

2. Are there any existing, pending or planned development proposal that would impact future transportation patterns near the culvert? If so, please explain.

Unknown

3. Is there any planned expansion of public transit or intercity transit service in the project area? Please provide the name and contact information for the relevant public transit provider.

No

Communications

1. Please identify any local communication outlets that are available for us to use in communicating with the local population. Include weekly or daily newspapers, blogs, radio, public access TV, Facebook, Front Page Forum, etc. Also include any unconventional means such as local low-power FM.

FPF, Times Argus, Washington World, Town website, Facebook, WDVE, WGER

2. Other than people/organizations already referenced in this questionnaire, are there any others who should be kept in the loop as the project moves forward?**Unknown**

Appendix L: Operations Input

Culvert Scoping Project BF 0241(56) Operations Input Questionnaire

The Structures Section has begun the scoping process for BF 0241(56), VT Route 12, Culvert 87, over the Hardwood Brook in Worcester. This is a CGMPPA culvert constructed in 1961. The Structure Inspection, Inventory, and Appraisal Sheet (attached) rates the culvert as 5 (fair). We are interested in hearing your thoughts regarding the items listed below. Leave it blank if you don't wish to comment on a particular item.

1. What are your thoughts on the general condition of this culvert and the general maintenance effort required to keep it in service?

Poor needs replacement or liner recent beaver activity has probably accelerated decay

2. What are your comments on the current geometry and alignment of the roadway over the culvert (curve, sag, banking, sight distance)?

Good but the slopes on both sides are steep

3. Do you feel that the posted speed limit is appropriate?

yes

4. Is the current roadway width adequate for winter maintenance including snow plowing?

Its adequate but due to the tilt of the road, the proximity to a corner and guard rail it's a tight area to meet other trucks while plowing even 4 feet wider road surface would help greatly

5. Are the railings constantly in need of repair or replacement? What type of railing works best for your district? (We are recommending more and more box beam guardrail on our culverts because of crash-worthiness and compatibility with accelerated projects).

No the W beam that's in place is good and fairly new

6. Are you aware of any unpermitted driveways within close proximity to the culvert? We frequently encounter driveways that prevent us from meeting railing and safety standards.

There is a log road on the east side and a small drive and garage on the west side un sure about permits. There are no permits issued in this area, Mike.

7. Are you aware of abutting property owners that are likely to need special attention during the planning and construction phases? These could be people with disabilities, elderly, or simply folks who feel they have been unfairly treated in the past.

The landowner on the east side is very hopeful of a project here with a solution to the beaver problem as when they plug are culvert it creates flooding on his land. I don't believe I have ever had contact with the land owner on the west side but I believe it's a elderly women that parks her car in the small garage that's located close to the culvert and walks up to the house I would suggest making contact with this land owner as any work performed on this culvert will impact her parking in her garage.

Culvert Scoping Project BF 0241(56)
Operations Input Questionnaire

8. Do you find that extra effort is required to keep the slopes and river banks around the culvert in a stable condition? Is there frequent flood damage that requires repair?

Both slopes are very steep but no recent memory of problems

9. Does this culvert seem to catch an unusual amount of debris from the waterway?

Yes, mostly due to beavers

10. Are you familiar with traffic volumes in the area of this project?

Low

11. Do you think a closure with off-site detour and accelerated construction would be appropriate?

Do you have any opinion about a possible detour route, assuming that we use State route for State projects and any route for Town projects? Are there locations on a potential detour that are already congested that we should consider avoiding?

I think closure with accelerated construction would be the only way to do a replacement, I do believe there is room to do a liner while maintain one way traffic

12. Please describe any larger projects that you have completed that may not be reflected on the attached Appraisal sheet, such as deck patches, paving patches, railing replacement with new type, steel coating, etc.

None

13. Are there any drainage issues that we should address on this project?

Property on east side floods due to beavers plugging culvert

14. Are you aware of any complaints that the public has about issues that we can address on this project?

Beavers causing flooding

15. Is there anything else we should be aware of?

Both ends of the culvert are extremely difficult to reach with are equipment due to slope and guard rail making routine maintenance such as simply cleaning out the end of the culvert or a debris catcher not so easy or simple

Appendix M: Detour Map

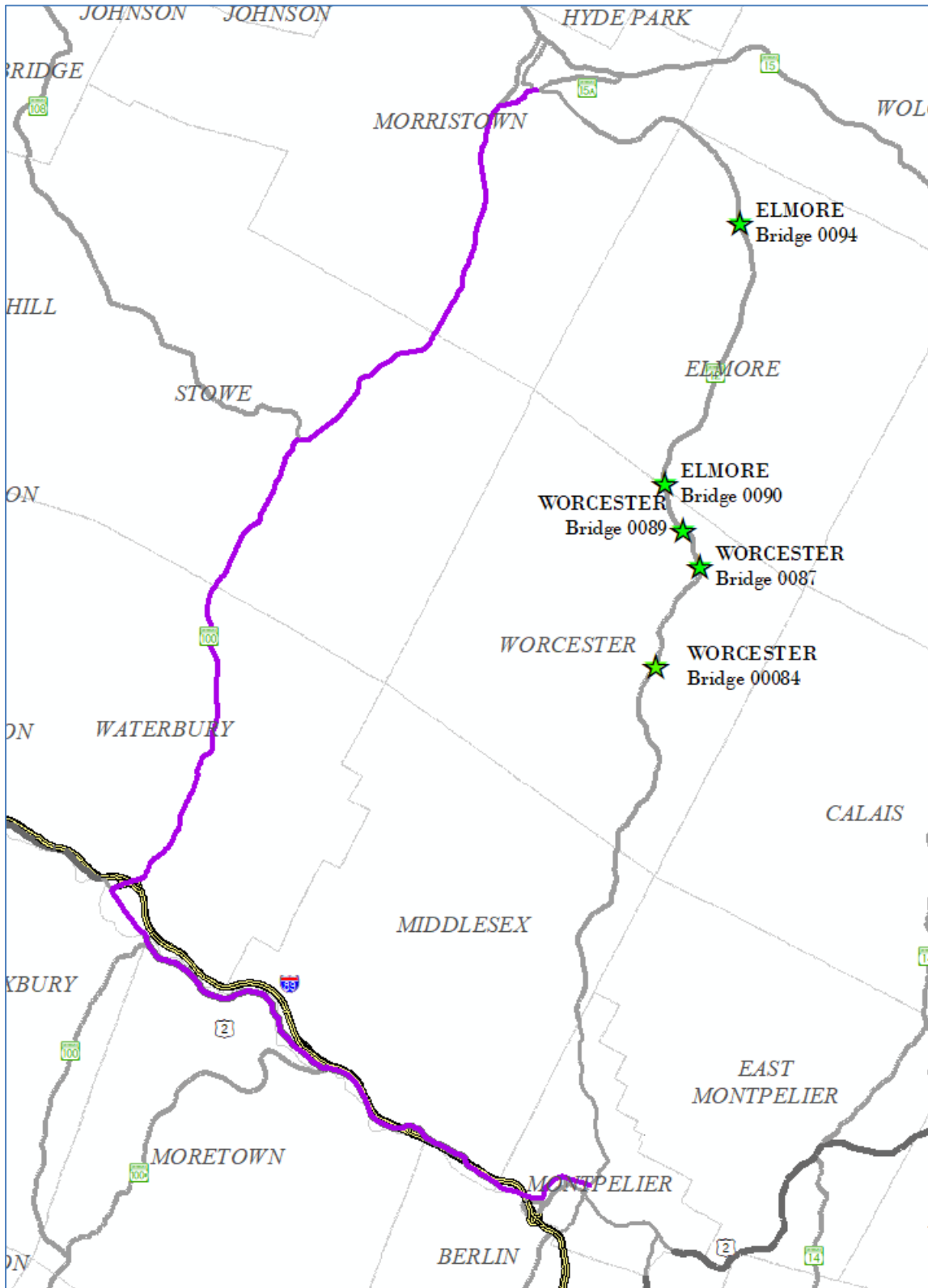

Regional Detour Route 1: VT Route 12, to VT Route 100, and US Route 2, back to VT Route 12

Through Route: 26.2 miles

Detour Route: 30.9 miles

Added Distance: 4.7 miles

End-to-End Distance: 57.1 miles

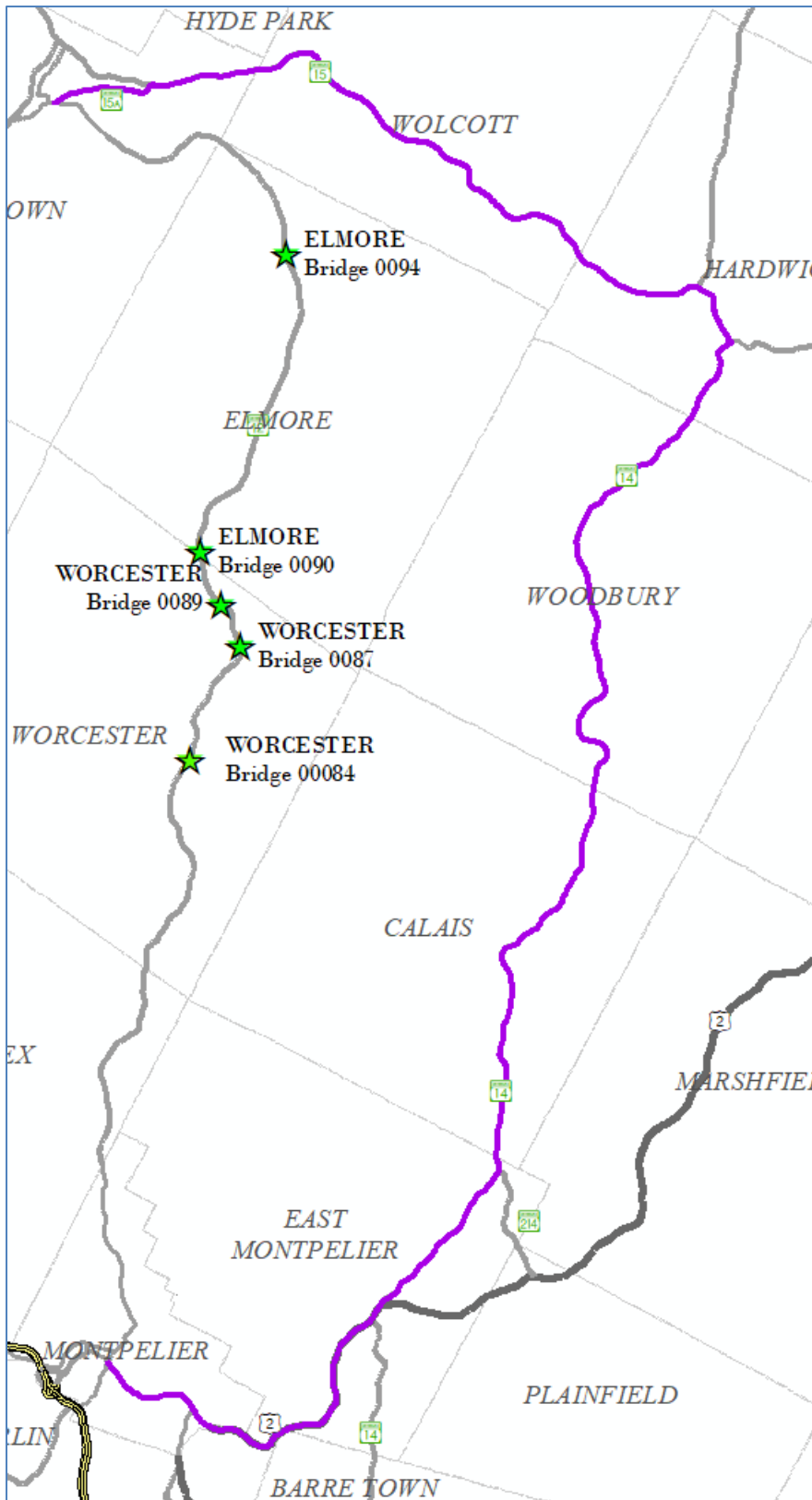

Regional Detour Route 2: VT Route 12, to US Route 2, VT Route 14, and VT Route 15, back to VT Route 12

Through Route: 26.4 miles
 Detour Route: 40.0 miles
 Added Distance: 13.6 miles
 End-to-End Distance: 66.4 miles

Appendix N: Plans

MEREDITH, JAMIE C.
& DAVIS, JENNIFER S.

LYON, LORY D.

STA 327+89.00=
CHAN 51+50.00
 $\Delta = 135^{\circ} 9' 50''$ LT

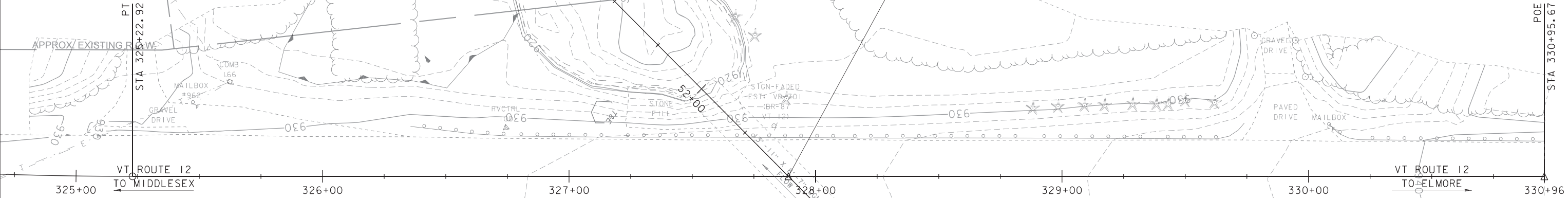

BENCHMARK
CHISLED SQUARE
ON LEDGE
ELEV. = 933.09

LOWE, DAVID E.;
SROKA, CHARLENE

BADO, VIRGINIA;
BADO, ROBERT T.;
BADO, JOHN A. III;
BADO, VIRGINIA A.;
BADO, THOMAS P.

EXISTING BRIDGE INFORMATION
BUILT 1961
13'-11" X 8'-7" X 96' CGMPPA
10' AVERAGE COVER
93 SQ.FT. WATERWAY AREA

EXISTING CONDITIONS

SCALE 1" = 20'-0"
0 20

PROJECT NAME: WORCHESTER
PROJECT NUMBER: BF 0241(56)

FILE NAME: I9b213/s19b213border.dgn
PROJECT LEADER: L.J.STONE
DESIGNED BY: -----
EXISTING CONDITIONS LAYOUT SHEET

PLOT DATE: 22-APR-2020
DRAWN BY: D.D.BEARD
CHECKED BY: -----
SHEET 1 OF 20

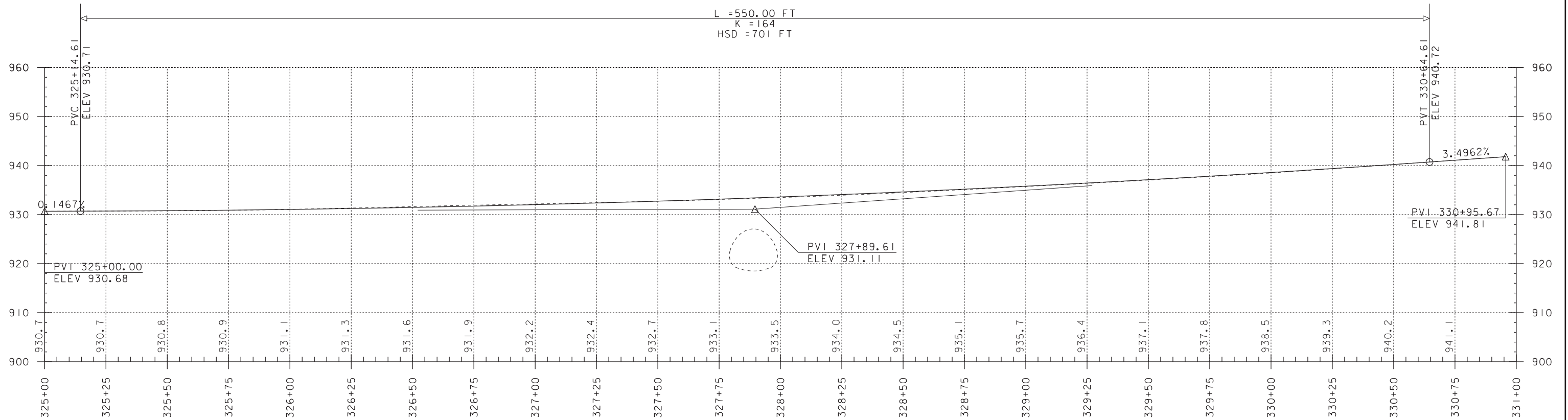

VT ROUTE 12 PROFILE

SCALE: HORIZONTAL 1"=20'-0"
VERTICAL 1"=10'-0"

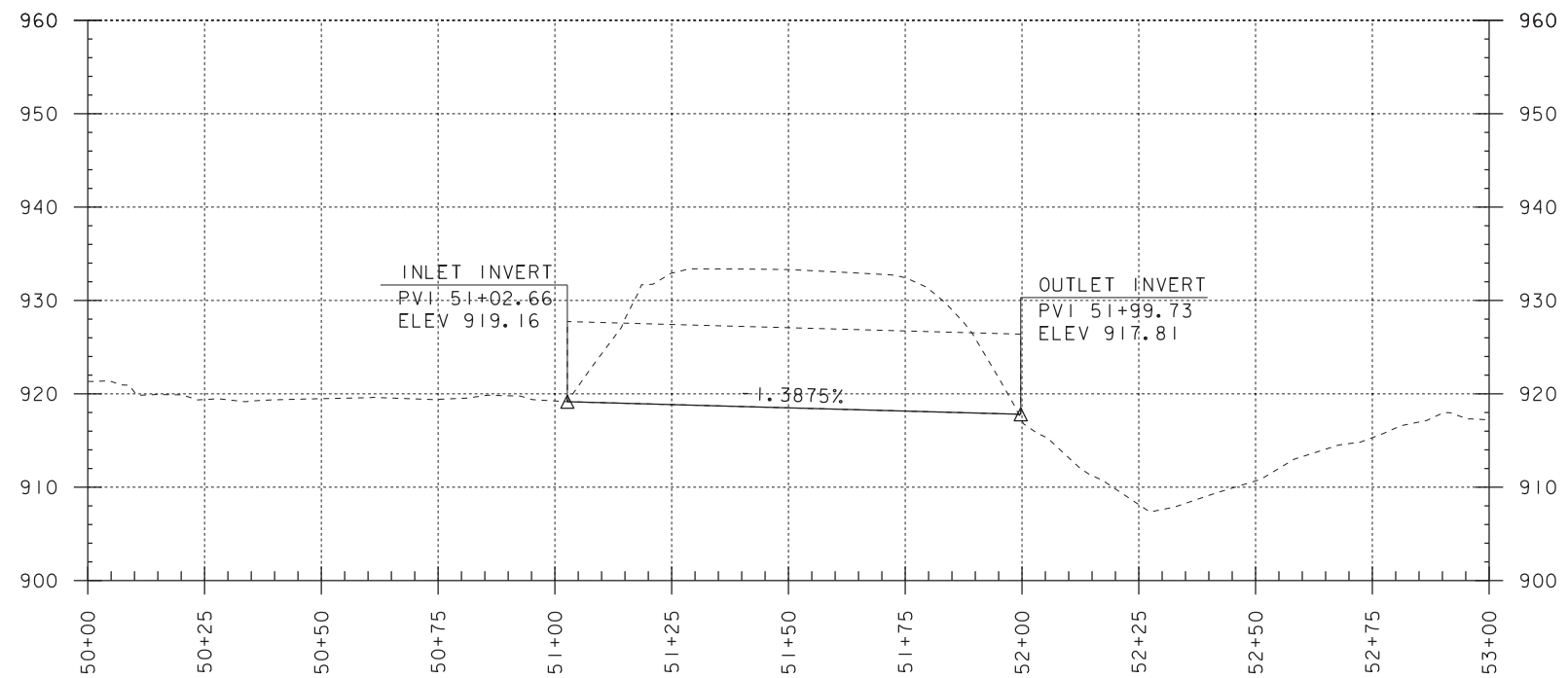

CULVERT 87 PROFILE

SCALE: HORIZONTAL 1"=20'-0"
VERTICAL 1"=10'-0"

NOTE:
GRADES SHOWN TO THE NEAREST
TENTH ARE EXISTING GROUND ALONG ϕ
GRADES SHOWN TO THE NEAREST
HUNDRETH ARE FINISH GRADE ALONG ϕ

PROJECT NAME: WORCESTER	PLOT DATE: 22-APR-2020
PROJECT NUMBER: BF 0241(56)	DRAWN BY: D.D.BEARD
FILE NAME: I9b213/sb9b213profile.dgn	CHECKED BY: -----
PROJECT LEADER: L.J.STONE	SHEET 2 OF 20
DESIGNED BY: -----	
PROFILE SHEET	

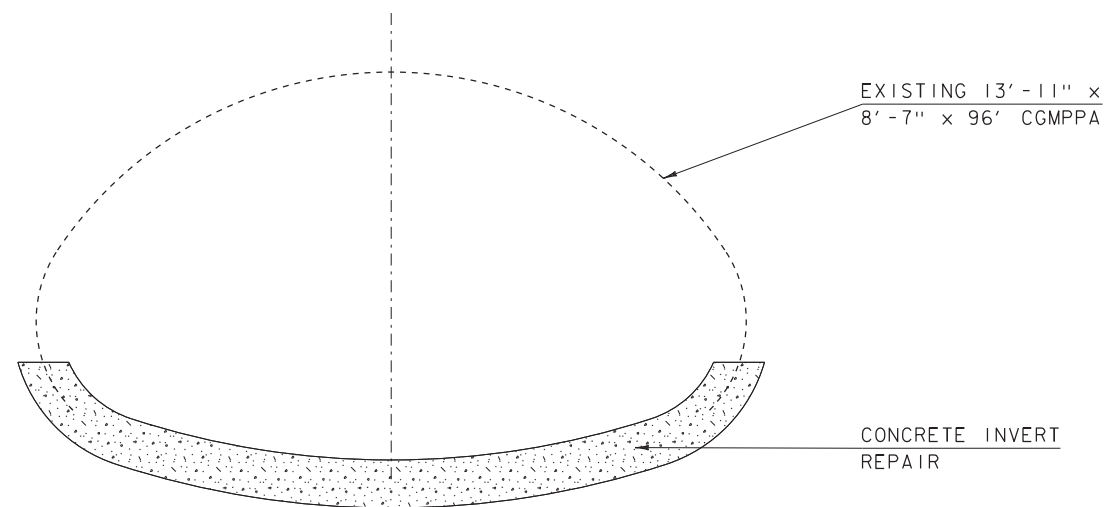

INVERT REHABILITATION TYPICAL SECTION

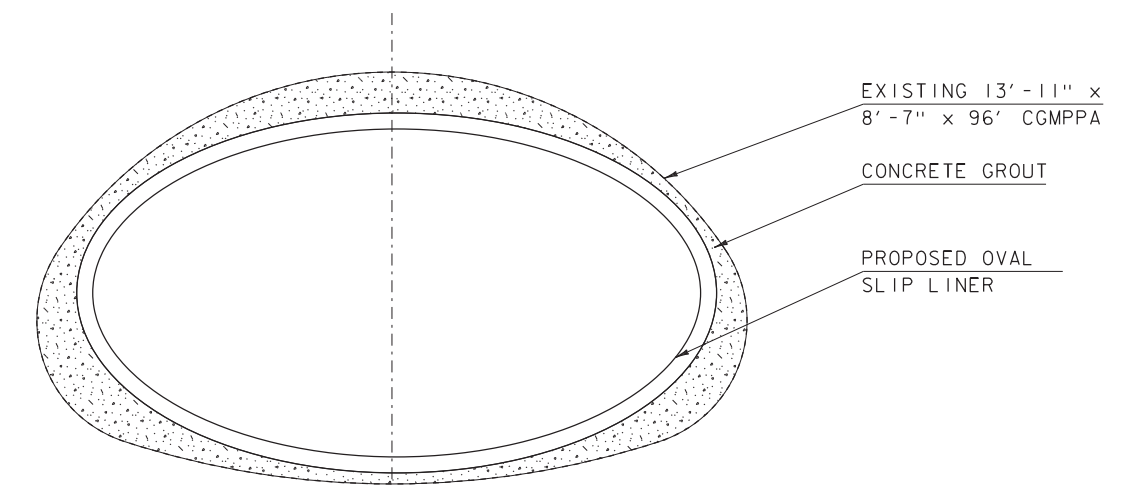

CULVERT LINER TYPICAL SECTION

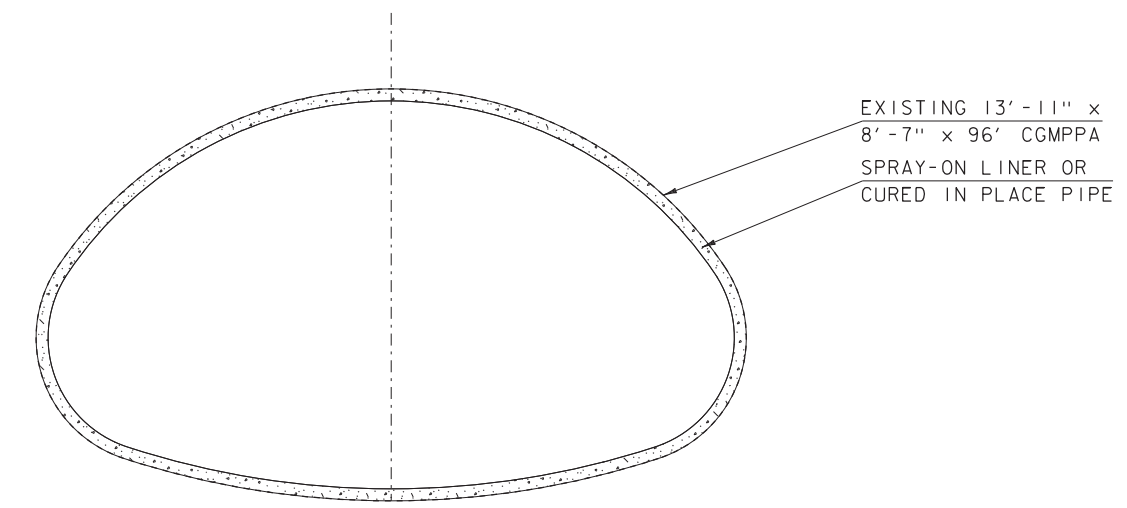

CONCRETE SPRAY ON LINER TYPICAL SECTION

PROJECT NAME:	WORCESTER	PLOT DATE:	22-APR-2020
PROJECT NUMBER:	BF 0241(56)	DRAWN BY:	D.D.BEARD
FILE NAME:	I9b213/sl9b213+typical.dgn	DESIGNED BY:	-----
PROJECT LEADER:	L.J.STONE	CHECKED BY:	-----
REHABILITATION TYPICAL SECTIONS		SHEET	3 OF 20

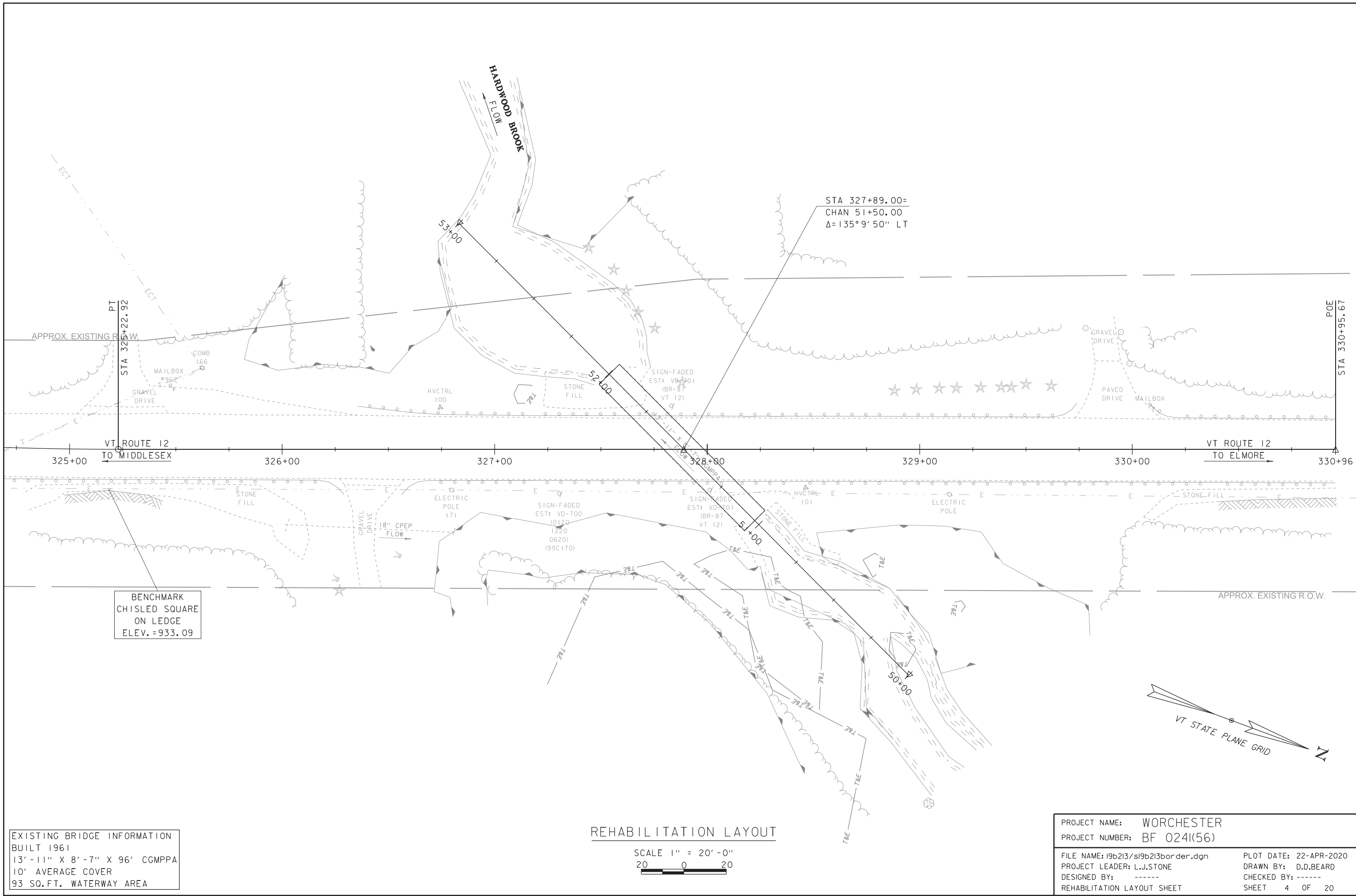

ECT
 APPROX. EXISTING R.O.W.
 STA 325+22.92
 PT

MAILBOX #362
 COMB 1.66
 GRAVEL DRIVE
 HVCTRL 100

VT ROUTE 12
 TO MIDDLESEX

325+00

326+00

327+00

328+00

329+00

330+00

VT ROUTE 12
 TO ELMORE

330+96
 POE

STA 327+89.00=
 CHAN 51+50.00
 $\Delta = 135^\circ 9' 50''$ LT

SIGN-FADED
 EST: VD-700
 (0120
 1220
 0620)
 (99C170)

SIGN-FADED
 EST: VD-701
 (BR-87
 VT 12)

BENCHMARK
 CHISLED SQUARE
 ON LEDGE
 ELEV. = 933.09

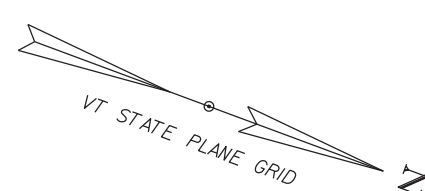

EXISTING BRIDGE INFORMATION
 BUILT 1961
 13'-11" X 8'-7" X 96' CGMPPA
 10' AVERAGE COVER
 93 SQ.FT. WATERWAY AREA

REHABILITATION LAYOUT

SCALE 1" = 20'-0"
 20 0 20

PROJECT NAME: WORCHESTER	PLOT DATE: 22-APR-2020
PROJECT NUMBER: BF 0241(56)	DRAWN BY: D.D.BEARD
FILE NAME: I9b213/sb9b213border.dgn	CHECKED BY: -----
PROJECT LEADER: L.J.STONE	SHEET 4 OF 20
DESIGNED BY: -----	
REHABILITATION LAYOUT SHEET	

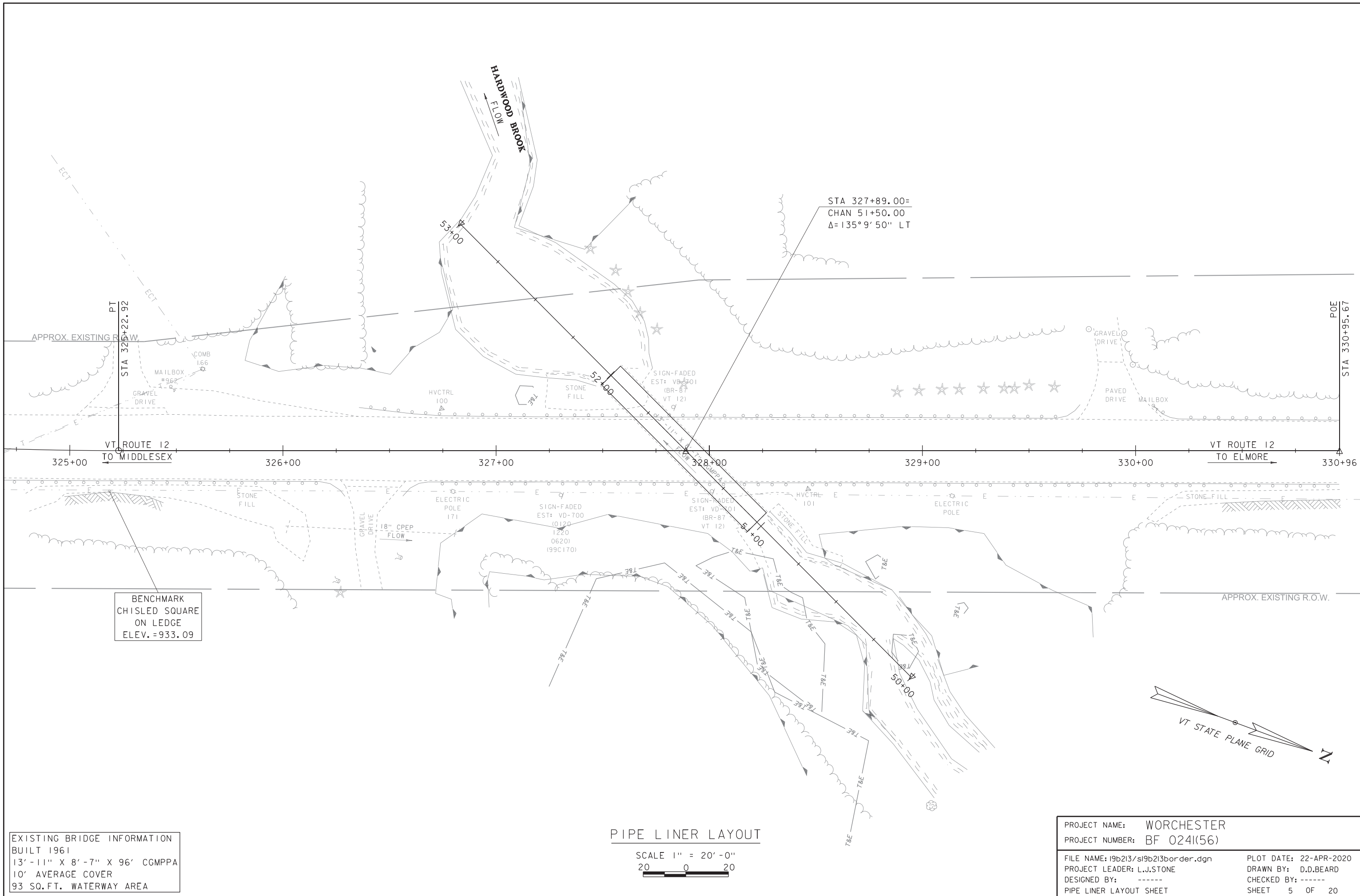

EXISTING BRIDGE INFORMATION
 BUILT 1961
 13'-11" X 8'-7" X 96' CGMPPA
 10' AVERAGE COVER
 93 SQ.FT. WATERWAY AREA

PIPE LINER LAYOUT
 SCALE 1" = 20'-0"
 20 0 20

PROJECT NAME: WORCHESTER	PLOT DATE: 22-APR-2020
PROJECT NUMBER: BF 0241(56)	DRAWN BY: D.D.BEARD
FILE NAME: I9b213/sb9b213border.dgn	CHECKED BY: -----
PROJECT LEADER: L.J.STONE	SHEET 5 OF 20
DESIGNED BY: -----	
PIPE LINER LAYOUT SHEET	

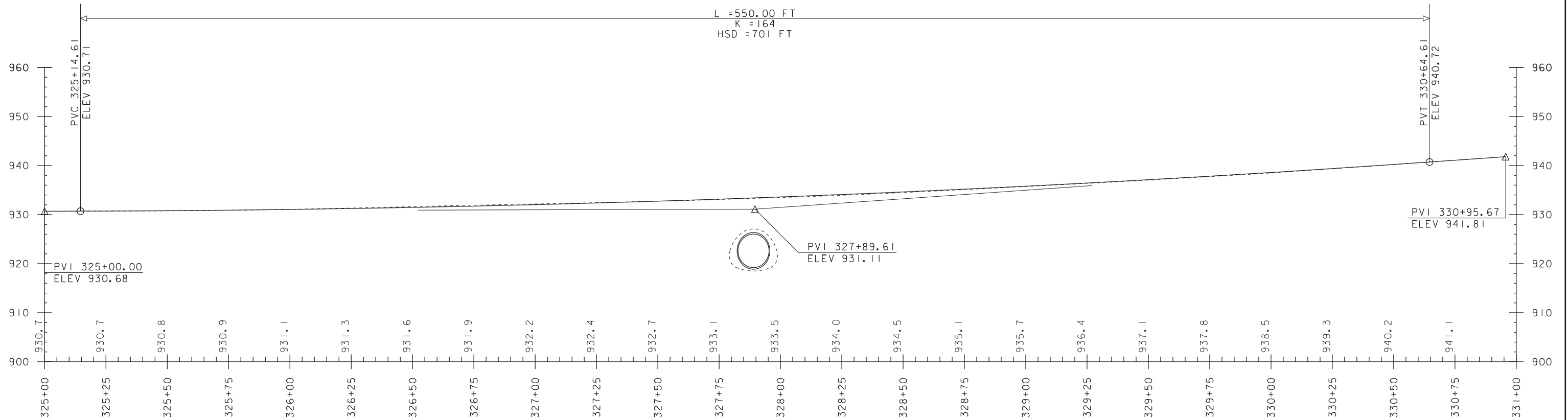

VT ROUTE 12 PROFILE

SCALE: HORIZONTAL 1"=20'-0"
 VERTICAL 1"=10'-0"

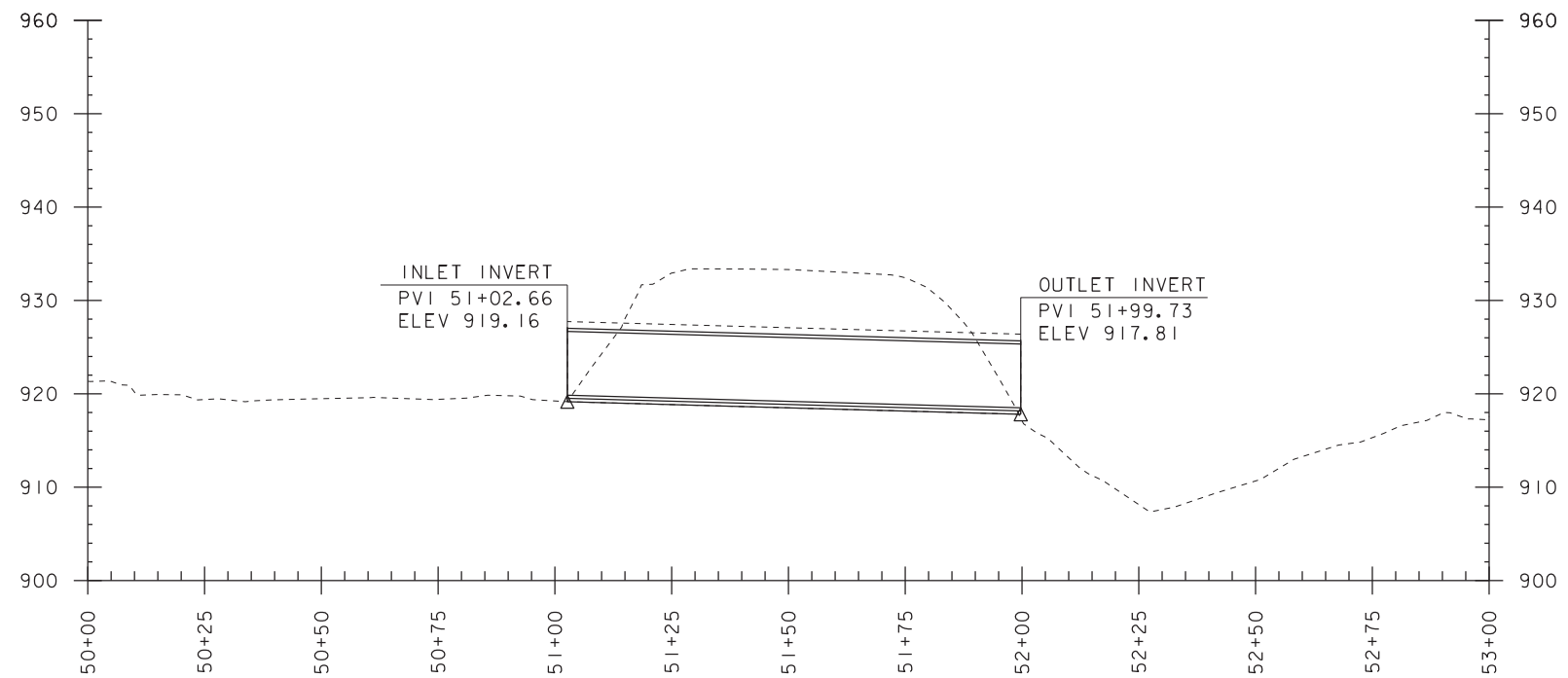

CULVERT 87 PROFILE

SCALE: HORIZONTAL 1"=20'-0"
 VERTICAL 1"=10'-0"

NOTE:
 GRADES SHOWN TO THE NEAREST TENTH ARE EXISTING GROUND ALONG CL
 GRADES SHOWN TO THE NEAREST HUNDREDTH ARE FINISH GRADE ALONG CL

PROJECT NAME: WORCESTER	PLOT DATE: 22-APR-2020
PROJECT NUMBER: BF 0241(56)	DRAWN BY: D.D.BEARD
FILE NAME: I9b213/sb9b213profile.dgn	CHECKED BY: -----
PROJECT LEADER: L.J.STONE	SHEET 6 OF 20
DESIGNED BY: -----	
PIPE LINER PROFILE SHEET	

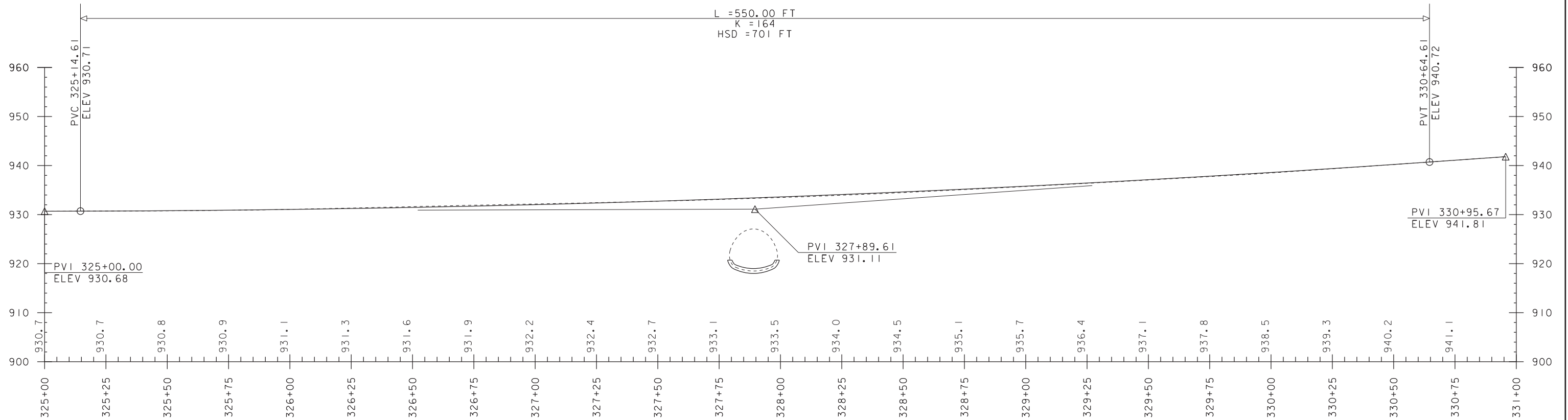

VT ROUTE 12 PROFILE

SCALE: HORIZONTAL 1"=20'-0"
 VERTICAL 1"=10'-0"

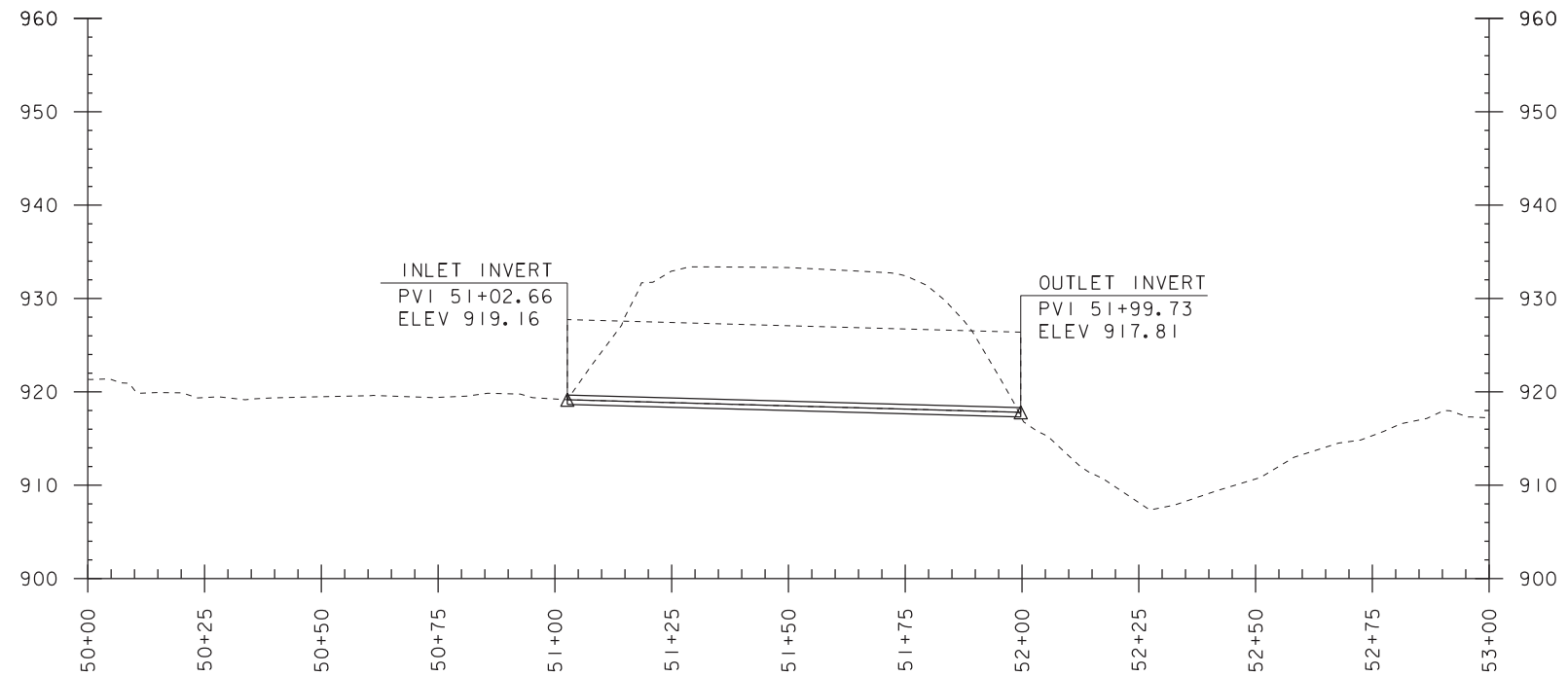

CULVERT 87 PROFILE

SCALE: HORIZONTAL 1"=20'-0"
 VERTICAL 1"=10'-0"

NOTE:
 GRADES SHOWN TO THE NEAREST
 TENTH ARE EXISTING GROUND ALONG ϕ
 GRADES SHOWN TO THE NEAREST
 HUNDRETH ARE FINISH GRADE ALONG ϕ

PROJECT NAME: WORCESTER	PLOT DATE: 22-APR-2020
PROJECT NUMBER: BF 0241(56)	DRAWN BY: D.D.BEARD
FILE NAME: I9b213/sb9b213profile.dgn	CHECKED BY: -----
PROJECT LEADER: L.J.STONE	SHEET 7 OF 20
DESIGNED BY: -----	INVERT REPAIR PROFILE SHEET

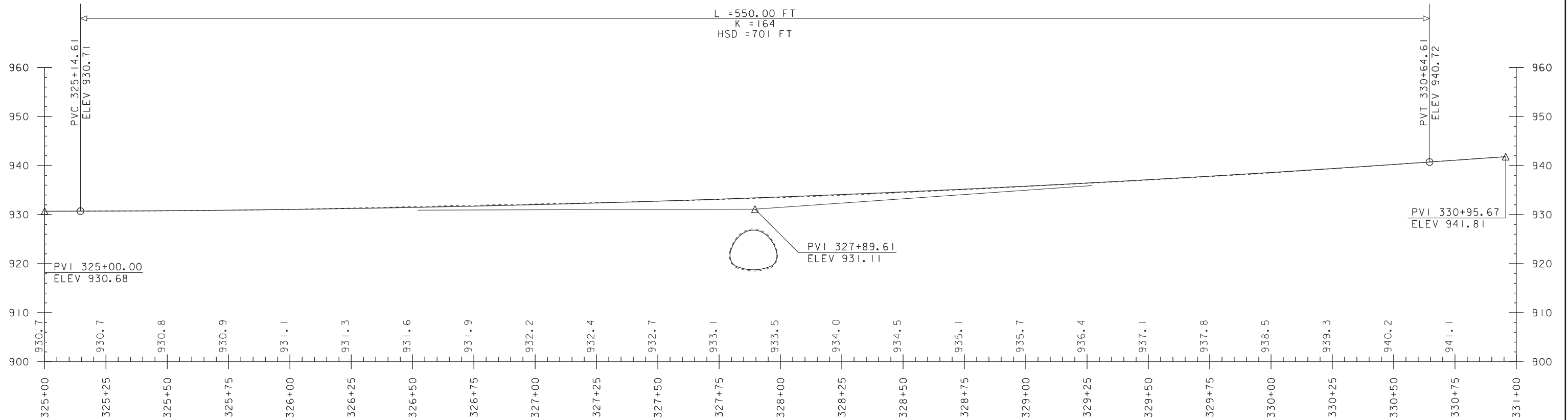

VT ROUTE 12 PROFILE

SCALE: HORIZONTAL 1"=20'-0"
 VERTICAL 1"=10'-0"

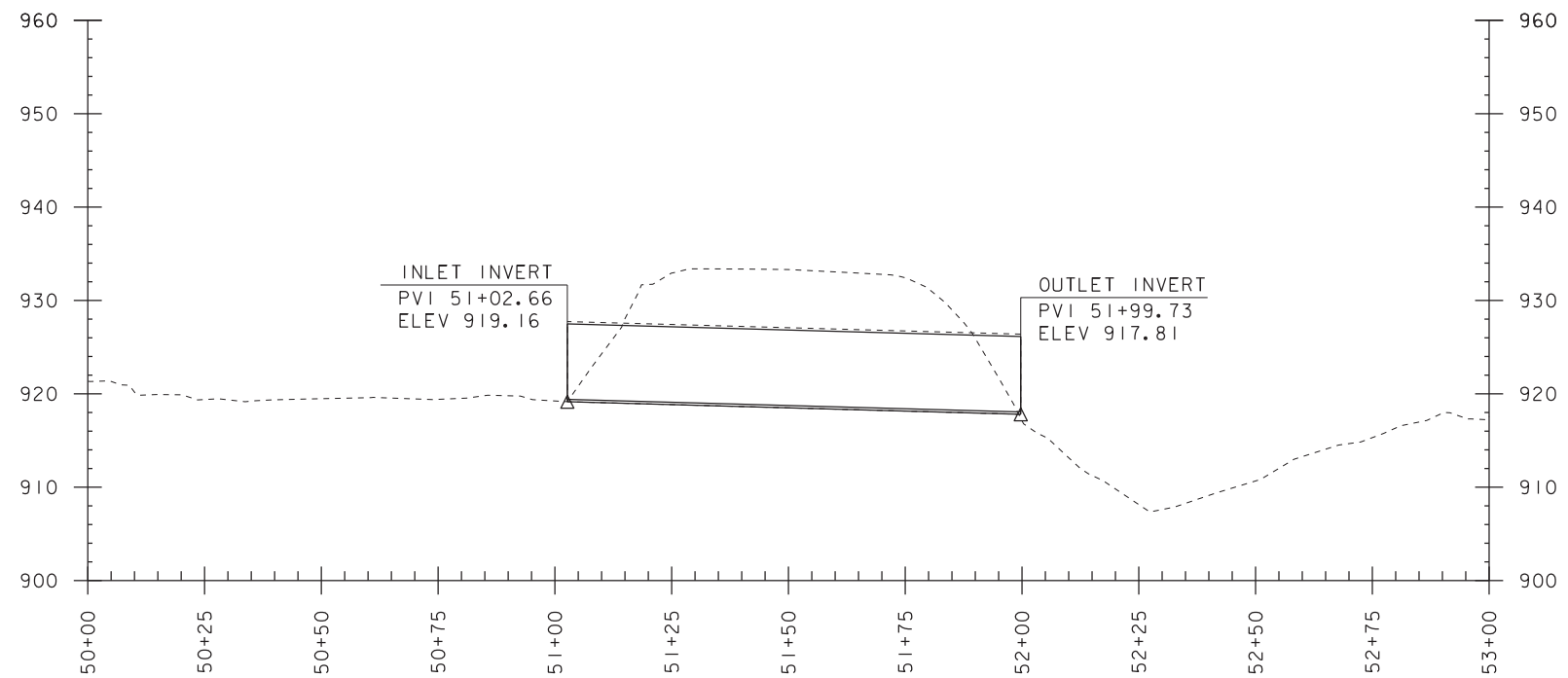

CULVERT 87 PROFILE

SCALE: HORIZONTAL 1"=20'-0"
 VERTICAL 1"=10'-0"

NOTE:
 GRADES SHOWN TO THE NEAREST TENTH ARE EXISTING GROUND ALONG CL
 GRADES SHOWN TO THE NEAREST HUNDRETH ARE FINISH GRADE ALONG CL

PROJECT NAME: WORCESTER	PLOT DATE: 22-APR-2020
PROJECT NUMBER: BF 0241(56)	DRAWN BY: D.D.BEARD
FILE NAME: I9b213/sb9b213profile.dgn	CHECKED BY: -----
PROJECT LEADER: L.J.STONE	SHEET 8 OF 20
DESIGNED BY: -----	
SPRAY ON LINER PROFILE SHEET	

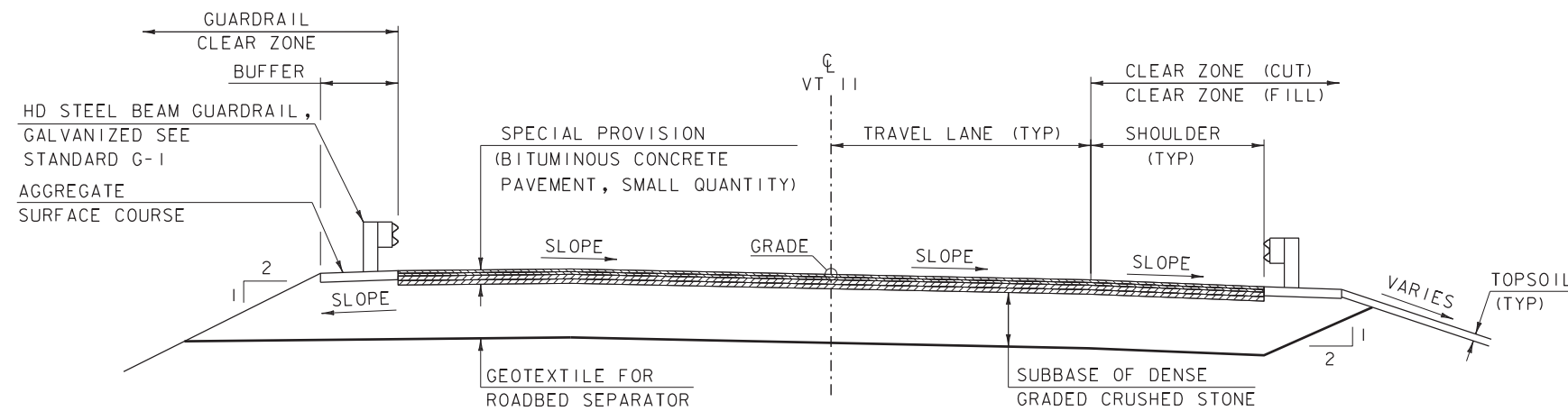

VTXX TYPICAL SECTION

SCALE: 1/4" = 1'-0"

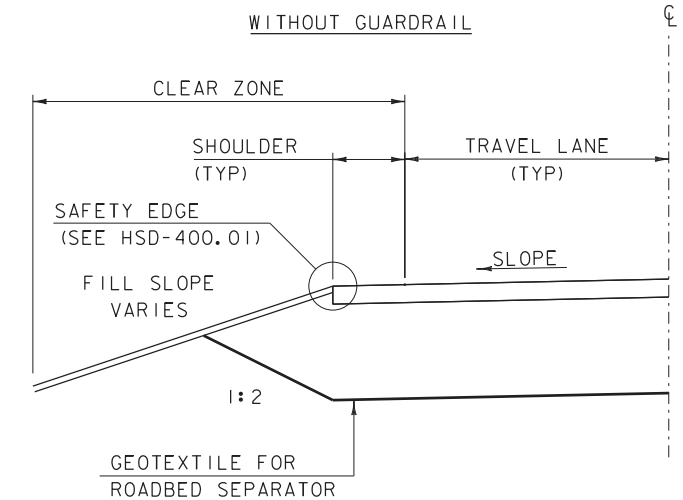

ROADWAY TYPICAL SECTION

NOT TO SCALE

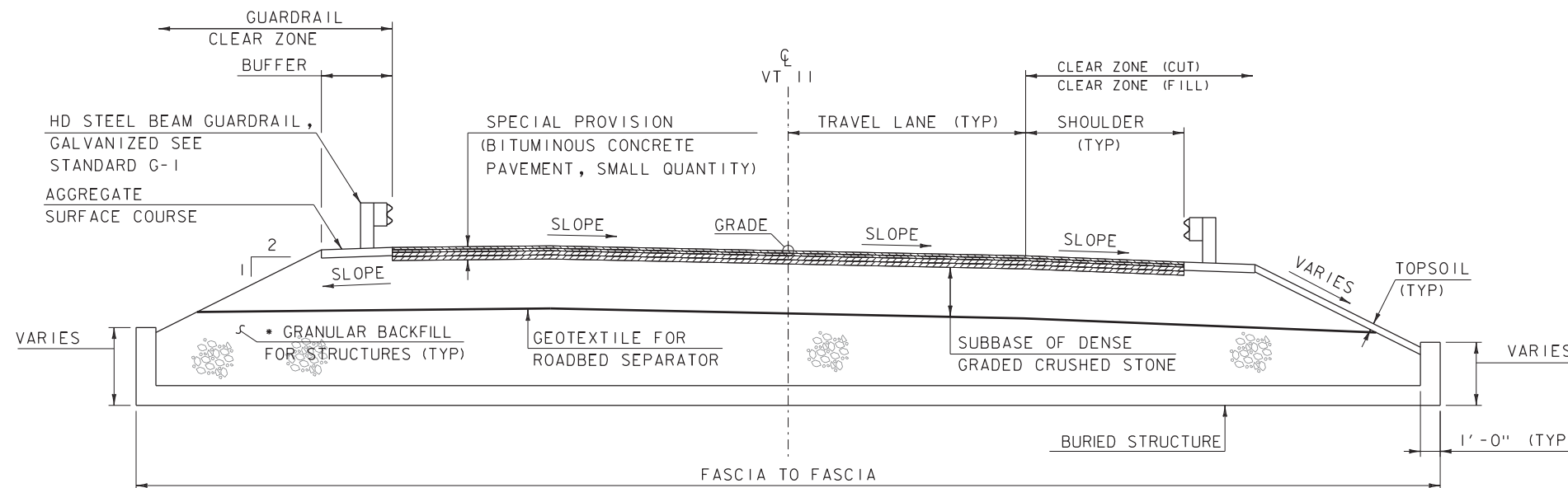

VTXX BURIED STRUCTURE TYPICAL SECTION

SCALE: 1/4" = 1'-0"

ROAD TYPICAL INFORMATION

	LEFT		RIGHT	
	WIDTH	SLOPE	WIDTH	SLOPE
TRAVEL LANE	11'-0"	VARIES	11'-0"	VARIES
SHOULDER	4'-0"	VARIES	4'-0"	VARIES
BUFFER	3'-7"	-0.060	3'-7"	-0.060
FILL SLOPE	---	VARIES	---	VARIES
CLEAR ZONE (CUT)	12'-0"	---	12'-0"	---
CLEAR ZONE (FILL)	16'-0"	---	16'-0"	---
CLEAR ZONE (GUARDRAIL)	4'-9"	---	4'-9"	---

MATERIAL INFORMATION

	THICKNESS	TYPE
WEARING COURSE	1 1/2"	SPECIAL PROVISION (BITUMINOUS CONCRETE PAVEMENT, SMALL QUANTITY) (TYPE IVS)
BINDER COURSE	1 1/2"	SPECIAL PROVISION (BITUMINOUS CONCRETE PAVEMENT, SMALL QUANTITY) (TYPE IVS)
BASE COURSE #2	2 1/2"	SPECIAL PROVISION (BITUMINOUS CONCRETE PAVEMENT, SMALL QUANTITY) (TYPE IIS)
BASE COURSE #1	2 1/2"	SPECIAL PROVISION (BITUMINOUS CONCRETE PAVEMENT, SMALL QUANTITY) (TYPE IIS)
BUFFER	8"	AGGREGATE SURFACE COURSE
SUBBASE	XX"	SUBBASE OF DENSE GRADED CRUSHED STONE
TOPSOIL	4"	TOPSOIL

TACK COAT: EMULSIFIED ASPHALT IS TO BE APPLIED AT A RATE OF 0.025 GAL/SY BETWEEN SUCCESSIVE COURSES OF PAVEMENT AND 0.080 GAL/SY ON COLD PLANED SURFACES AS DIRECTED BY THE ENGINEER.

MATERIAL TOLERANCES
(IF USED ON PROJECT)

SURFACE	
- PAVEMENT (TOTAL THICKNESS)	+/- 1/4"
- AGGREGATE SURFACE COURSE	+/- 1/2"
SUBBASE	+/- 1"
SAND BORROW	+/- 1"

PROJECT NAME: WORCESTER
PROJECT NUMBER: BF 0241(56)

FILE NAME: I9b213/sb9b213+yp.dgn
PROJECT LEADER: L.J.STONE
DESIGNED BY: -----
TYPICAL SECTION SHEET 1

PLOT DATE: 22-APR-2020
DRAWN BY: D.D.BEARD
CHECKED BY: -----
SHEET 9 OF 20

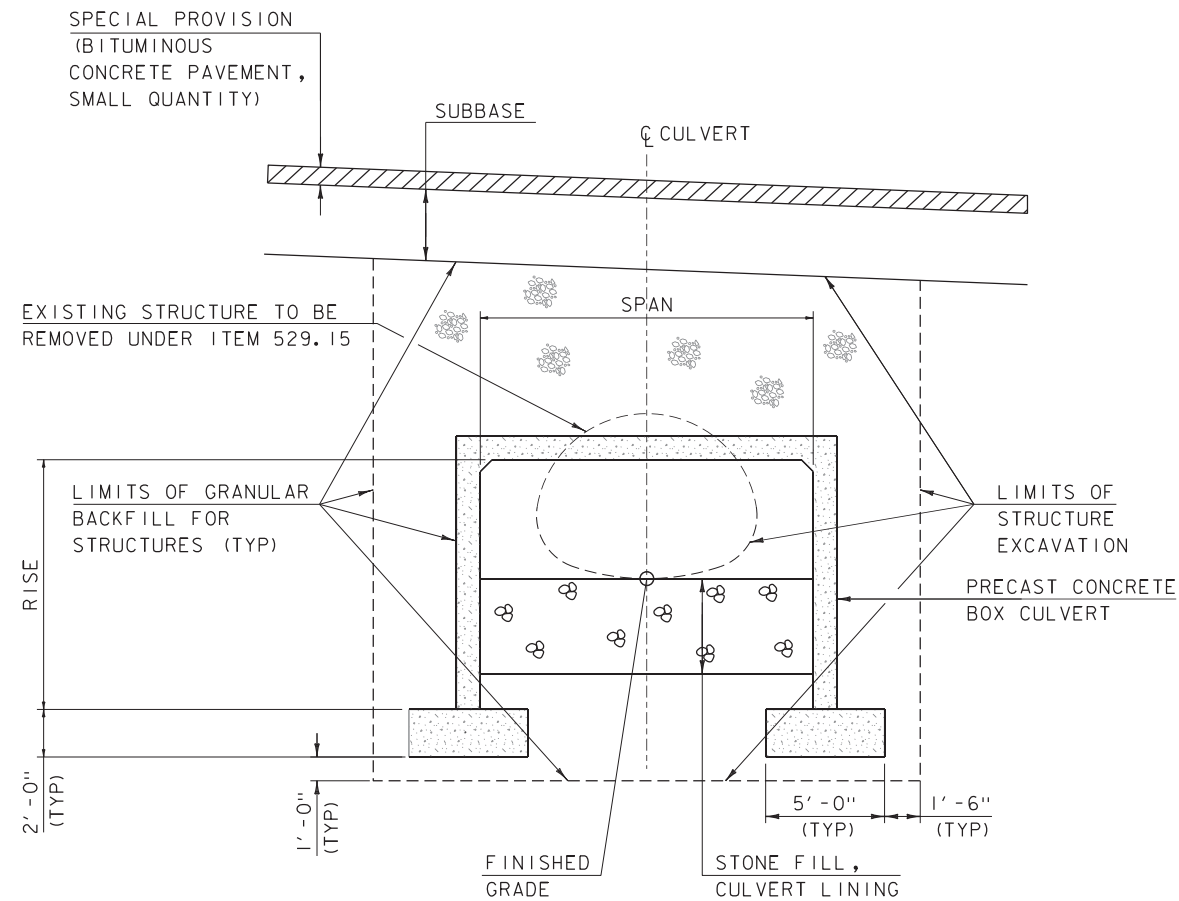

SPAN	20' - 0"
RISE	13' - 0"
LENGTH	100' - 0"

CULVERT TYPICAL SECTION

NOT TO SCALE

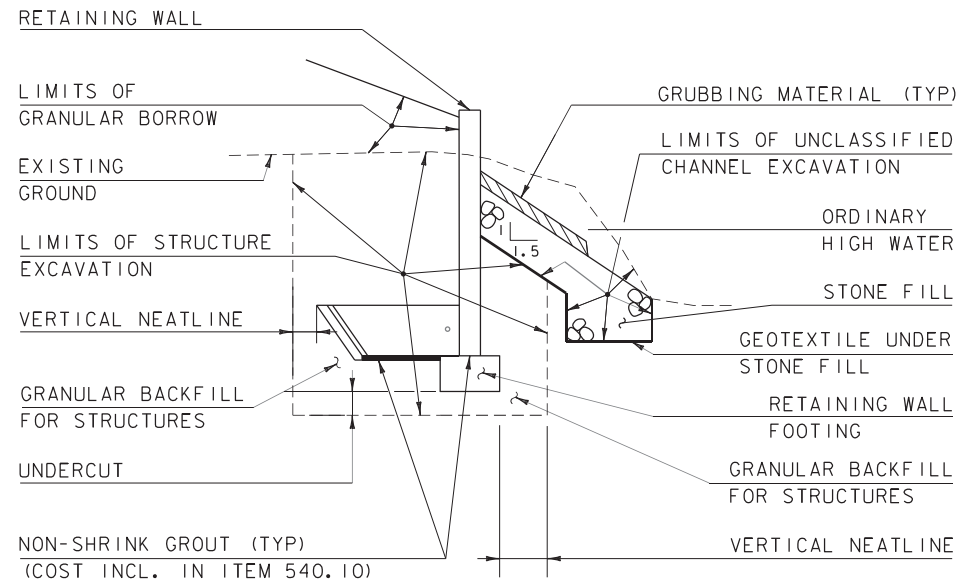

RETAINING WALL EARTHWORK TYPICAL SECTION

NOT TO SCALE

NOTE:

TOP OF RETAINING WALL FOOTING SHALL BE AT OR BELOW BOTTOM OF BOX CULVERT.

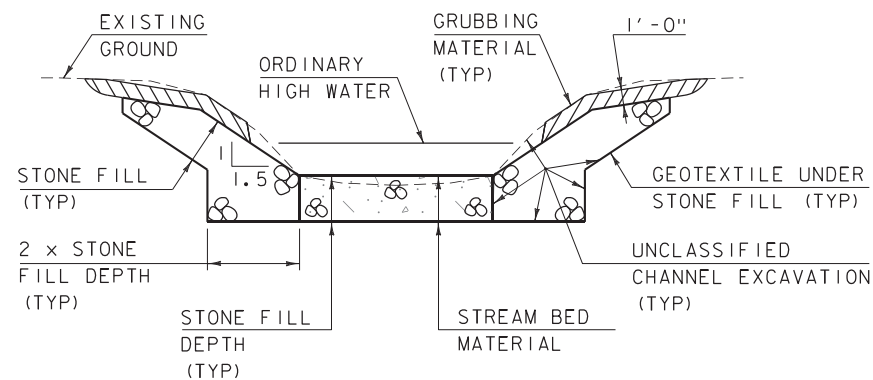

TYPICAL CHANNEL SECTION

(NOT TO SCALE)

- 1) WHENEVER CHANNEL SLOPE INTERSECTS ROADWAY SUBBASE, GRUBBING MATERIAL SHALL BEGIN AT THE BOTTOM OF SUBBASE.
- 2) THE CONTRACTOR SHALL CREATE A LOW FLOW CHANNEL IN THE STREAM BED MATERIAL AS DIRECTED BY THE ENGINEER.
- 3) GRUBBING MATERIAL SHALL BE PLACED UNDERNEATH STRUCTURES WHERE THERE IS MORE THAN 6 FEET VERTICALLY FROM ORDINARY HIGH WATER (OHW) TO THE BOTTOM OF SUPERSTRUCTURE AND MORE THAN 6 FEET HORIZONTALLY FROM OHW LINE TO FRONT FACE OF ABUTMENT. THIS MATERIAL SHALL START JUST ABOVE THE OHW ELEVATION AND TERMINATE 3 FEET HORIZONTALLY FROM THE FRONT FACE OF THE ABUTMENT. THIS MATERIAL SHALL NOT BE PLACED UNDERNEATH DOWNSPOUTS. SEE THE CHANNEL SECTIONS FOR ADDITIONAL DETAILING.

MATERIAL INFORMATION

	THICKNESS	TYPE
STONE FILL	4' - 0"	TYPE IV
STONE FILL, CULVERT LINING	4' - 0"	E-STONE TYPE IV
STONE FILL, STREAM BED MATERIAL	4' - 0"	E-STONE TYPE IV

RETAINING WALL - ASSUMED DIMENSIONS

LEVELING PAD	
WIDTH	DIMENSION
WIDTH	2' - 6"
TOE	0' - 9"
HEEL	0' - 9"
THICKNESS	1' - 0"
UNDERCUT	1' - 0"
WALL	
THICKNESS	1' - 0"
HEIGHT	VARIES
EXCAVATION LIMITS	
VERTICAL NEATLINE	1' - 6"
UNDERCUT	1' - 0"

PROJECT NAME: WORCESTER
PROJECT NUMBER: BF 0241(56)

FILE NAME: I9b213/s19b213+yp.dgn PLOT DATE: 22-APR-2020
PROJECT LEADER: L.J.STONE DRAWN BY: D.D.BEARD
DESIGNED BY: ----- CHECKED BY: -----
3-SIDED TYPICAL SECTION SHEET 10 OF 20

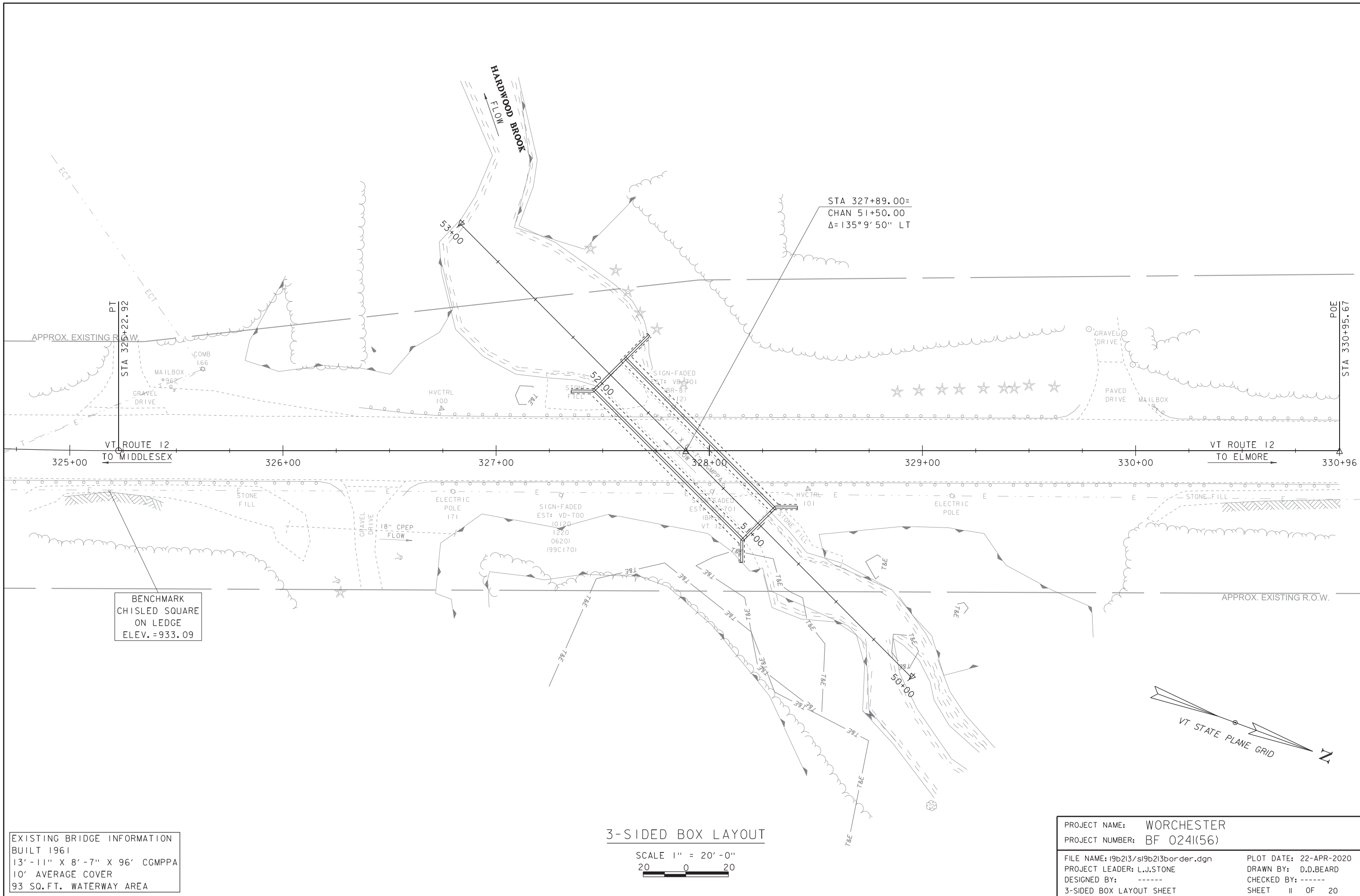

EXISTING BRIDGE INFORMATION
 BUILT 1961
 13'-11" X 8'-7" X 96' CGMPPA
 10' AVERAGE COVER
 93 SQ.FT. WATERWAY AREA

3-SIDED BOX LAYOUT
 SCALE 1" = 20'-0"
 20 0 20

PROJECT NAME: WORCHESTER	PLOT DATE: 22-APR-2020
PROJECT NUMBER: BF 0241(56)	DRAWN BY: D.D.BEARD
FILE NAME: I9b213/s19b213border.dgn	CHECKED BY: -----
PROJECT LEADER: L.J.STONE	SHEET II OF 20
DESIGNED BY: -----	
3-SIDED BOX LAYOUT SHEET	

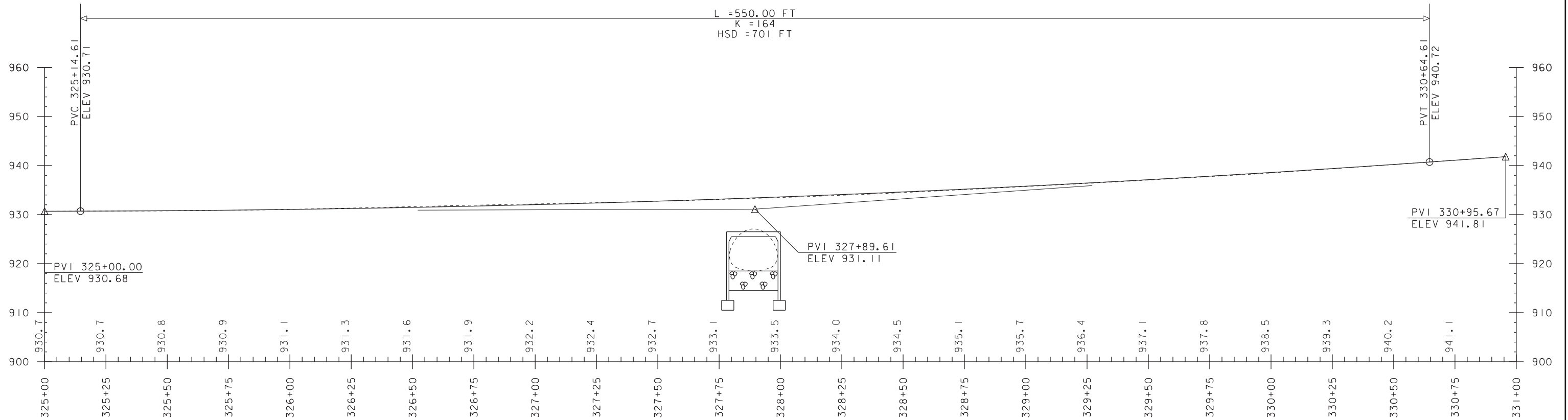

VT ROUTE 12 PROFILE

SCALE: HORIZONTAL 1"=20'-0"
 VERTICAL 1"=10'-0"

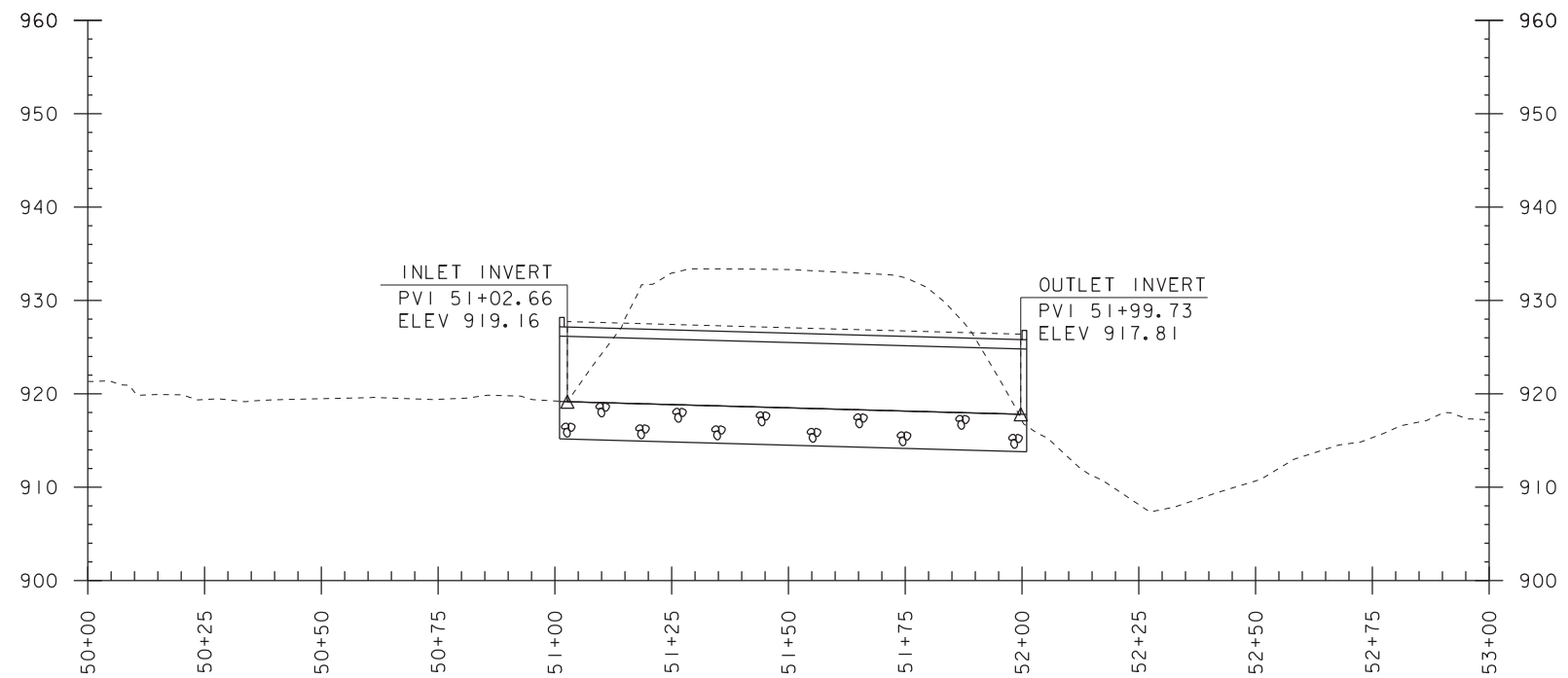

CULVERT 87 PROFILE

SCALE: HORIZONTAL 1"=20'-0"
 VERTICAL 1"=10'-0"

NOTE:
 GRADES SHOWN TO THE NEAREST TENTH ARE EXISTING GROUND ALONG CL
 GRADES SHOWN TO THE NEAREST HUNDRETH ARE FINISH GRADE ALONG CL

PROJECT NAME: WORCESTER	PLOT DATE: 22-APR-2020
PROJECT NUMBER: BF 0241(56)	DRAWN BY: D.D.BEARD
FILE NAME: I9b213/sb9b213profile.dgn	CHECKED BY: -----
PROJECT LEADER: L.J.STONE	SHEET 12 OF 20
DESIGNED BY: -----	
3-SIDED BOX PROFILE SHEET	

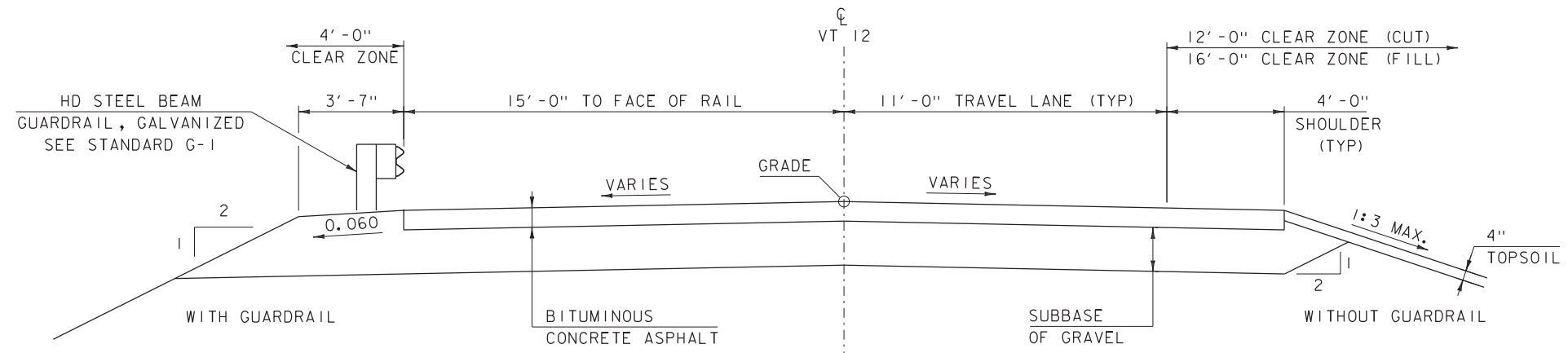

PROPOSED VT 12 TYPICAL SECTION

SCALE $\frac{3}{8}$ " = 1'-0"

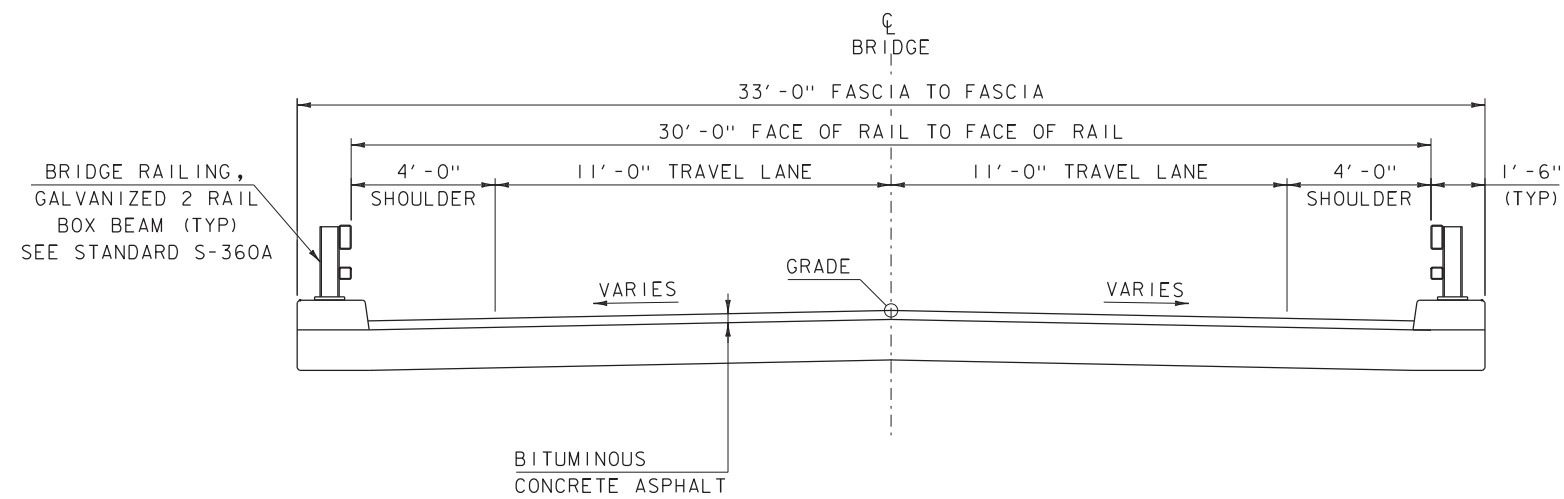

PROPOSED BRIDGE TYPICAL SECTION

SCALE $\frac{3}{8}$ " = 1'-0"

MATERIAL TOLERANCES
(IF USED ON PROJECT)

SURFACE	
- PAVEMENT (TOTAL THICKNESS)	+/- 1/4"
- AGGREGATE SURFACE COURSE	+/- 1/2"
SUBBASE	+/- 1"
SAND BORROW	+/- 1"

PROJECT NAME: WORCESTER

PROJECT NUMBER: BF 0241(56)

FILE NAME: I9b213\sb9b213\typical.dgn

PROJECT LEADER: L.J.STONE

DESIGNED BY: -----

NEW BRIDGE TYPICAL SECTIONS

PLOT DATE: 22-APR-2020

DRAWN BY: D.D.BEARD

CHECKED BY: -----

SHEET 13 OF 20

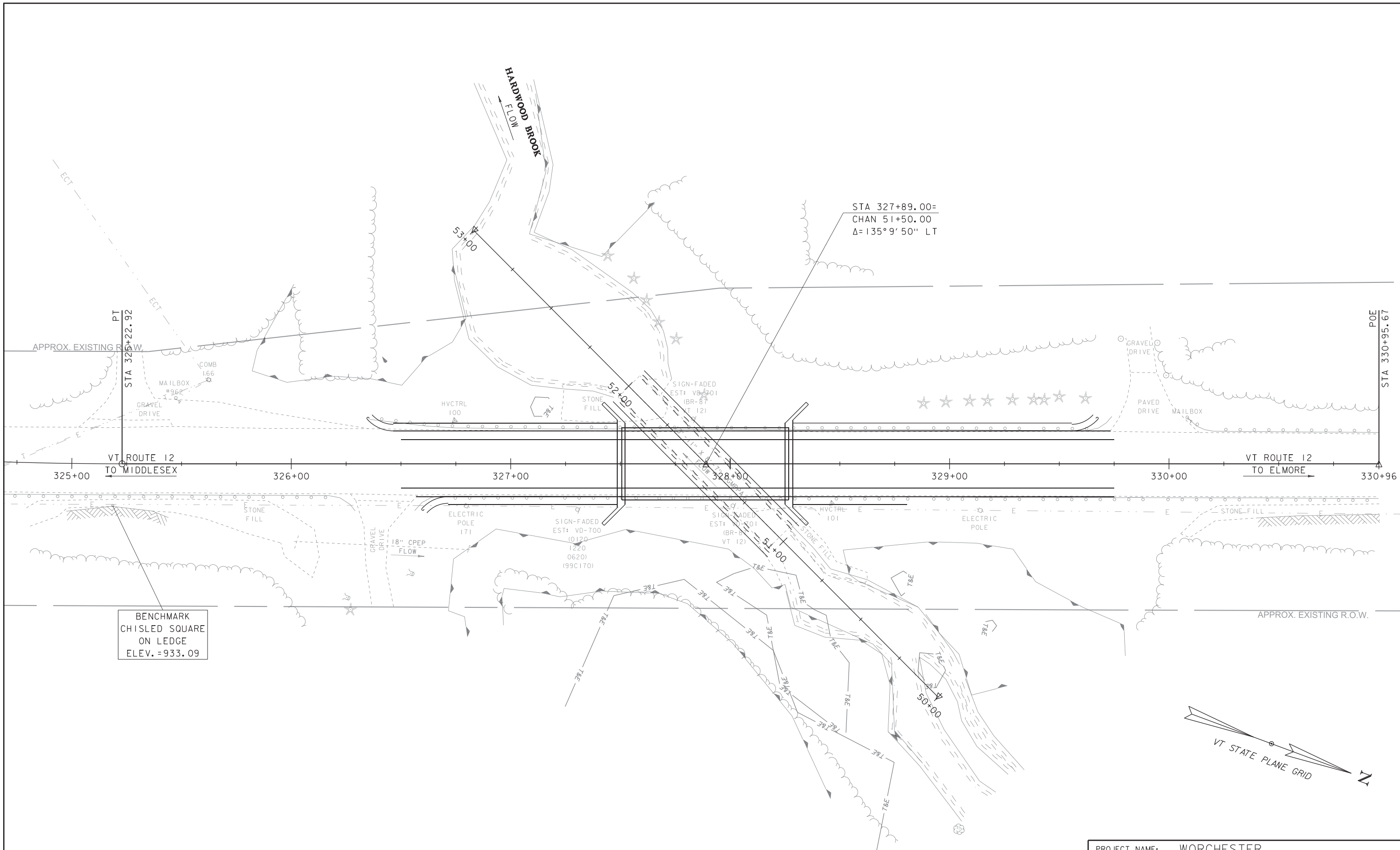

EXISTING BRIDGE INFORMATION
 BUILT 1961
 13'-11" X 8'-7" X 96' CGMPPA
 10' AVERAGE COVER
 93 SQ.FT. WATERWAY AREA

NEW BRIDGE LAYOUT

SCALE 1" = 20'-0"
 20 0 20

PROJECT NAME: WORCHESTER	PLOT DATE: 22-APR-2020
PROJECT NUMBER: BF 0241(56)	DRAWN BY: D.D.BEARD
FILE NAME: I9b213/s19b213border.dgn	CHECKED BY: -----
PROJECT LEADER: L.J.STONE	SHEET 14 OF 20
DESIGNED BY: -----	
NEW BRIDGE LAYOUT SHEET	

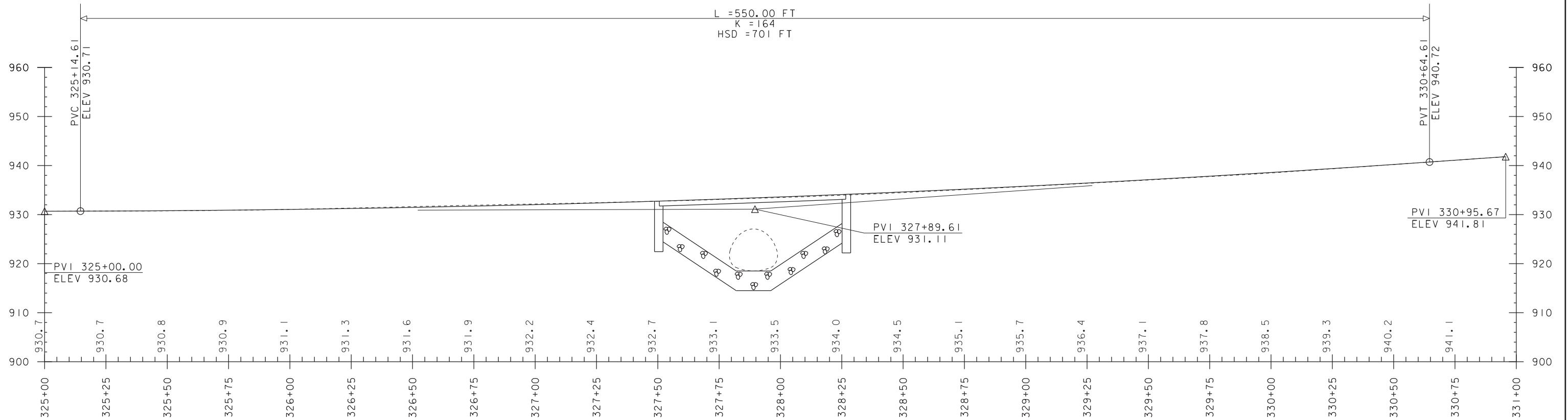

VT ROUTE 12 PROFILE

SCALE: HORIZONTAL 1"=20'-0"
VERTICAL 1"=10'-0"

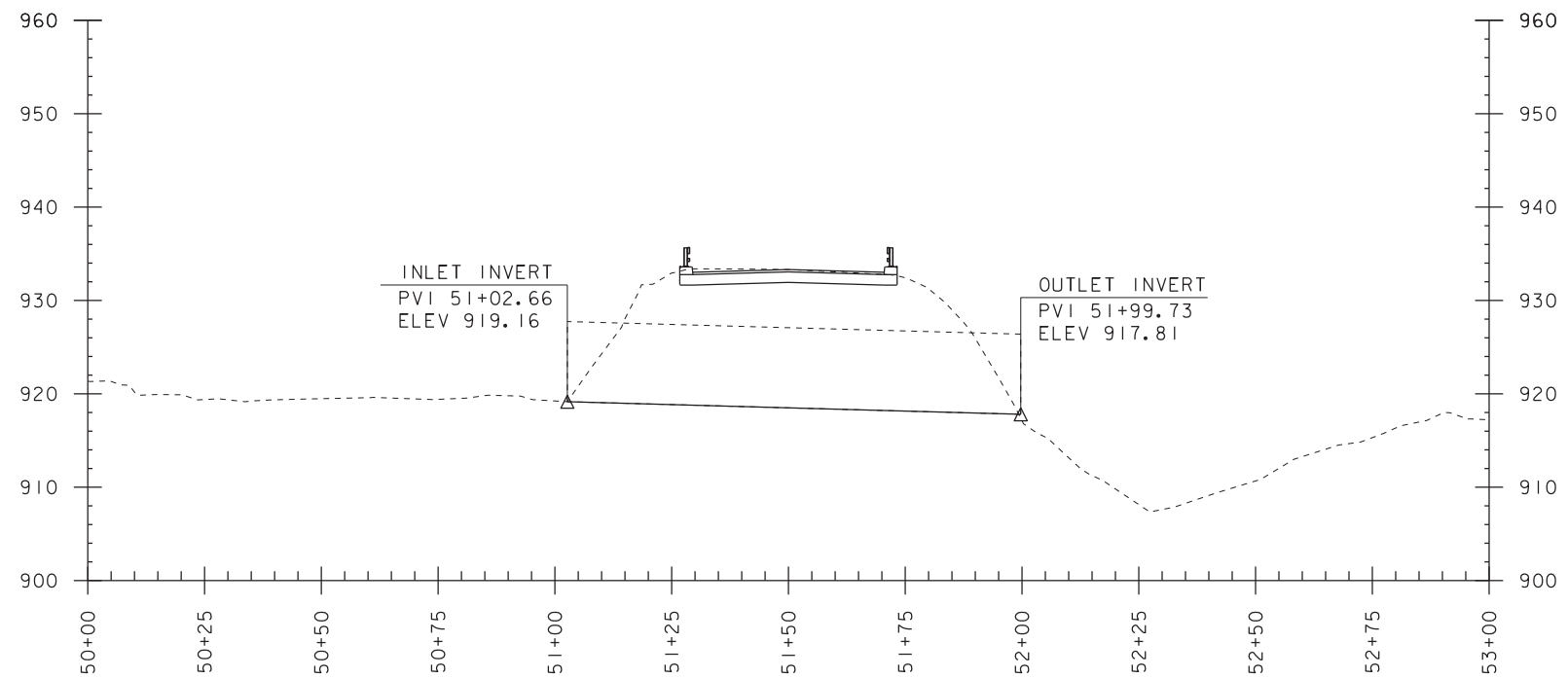

CULVERT 87 PROFILE

SCALE: HORIZONTAL 1"=20'-0"
VERTICAL 1"=10'-0"

NOTE:
GRADES SHOWN TO THE NEAREST TENTH ARE EXISTING GROUND ALONG CL
GRADES SHOWN TO THE NEAREST HUNDRETH ARE FINISH GRADE ALONG CL

PROJECT NAME: WORCESTER	PLOT DATE: 22-APR-2020
PROJECT NUMBER: BF 0241(56)	DRAWN BY: D.D.BEARD
FILE NAME: I9b213/sb9b213profile.dgn	CHECKED BY: -----
PROJECT LEADER: L.J.STONE	SHEET 15 OF 20
DESIGNED BY: -----	
NEW BRIDGE PROFILE SHEET	

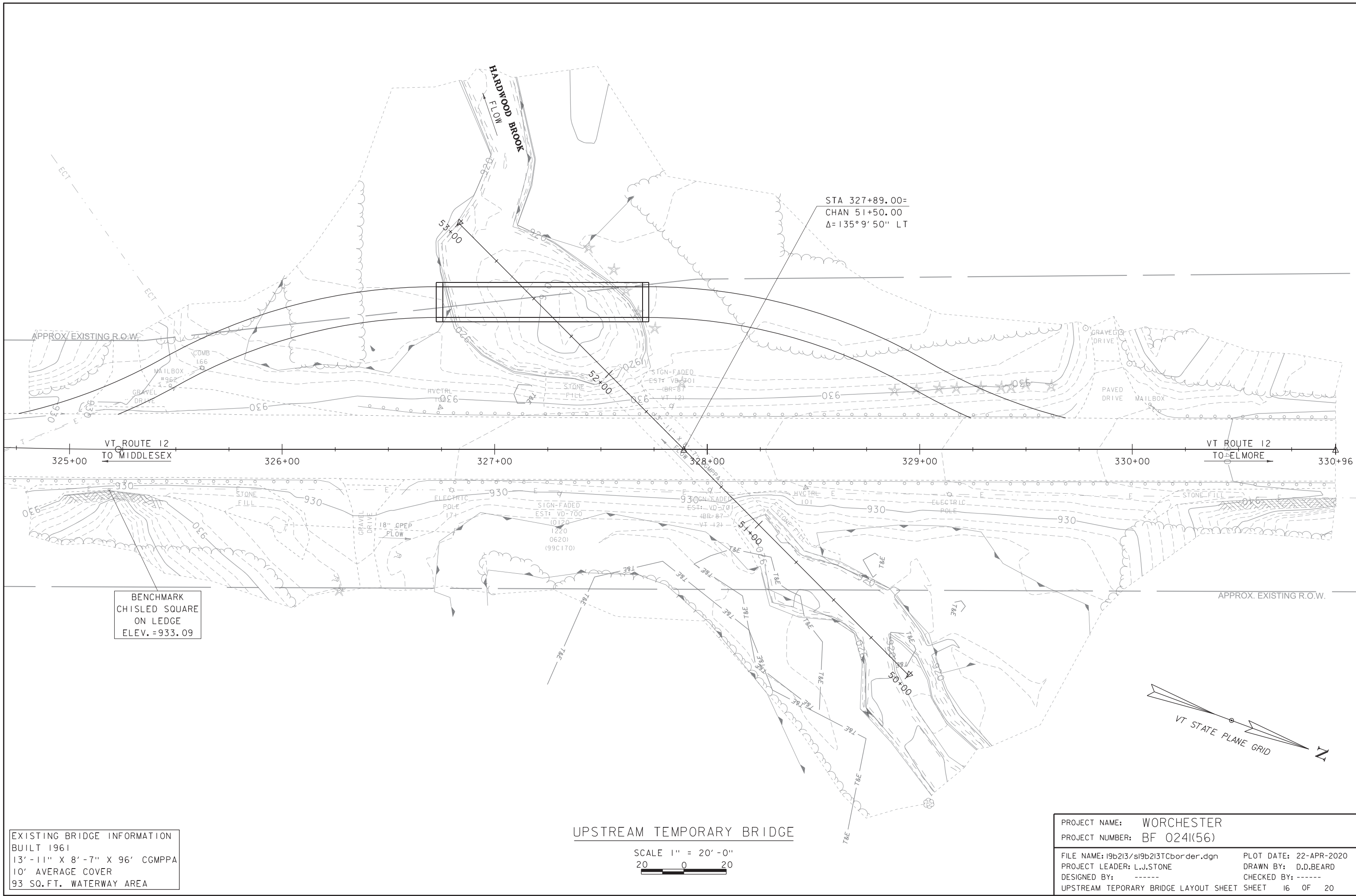

EXISTING BRIDGE INFORMATION
 BUILT 1961
 13'-11" X 8'-7" X 96' CGMPPA
 10' AVERAGE COVER
 93 SQ.FT. WATERWAY AREA

UPSTREAM TEMPORARY BRIDGE

SCALE 1" = 20'-0"
 20 0 20

PROJECT NAME:	WORCHESTER	PLOT DATE:	22-APR-2020
PROJECT NUMBER:	BF 0241(56)	DRAWN BY:	D.D.BEARD
FILE NAME:	I9b213/s19b213Tcborder.dgn	CHECKED BY:	-----
PROJECT LEADER:	L.J.STONE	DESIGNED BY:	-----
UPSTREAM TEMPORARY BRIDGE LAYOUT SHEET		SHEET 16 OF 20	

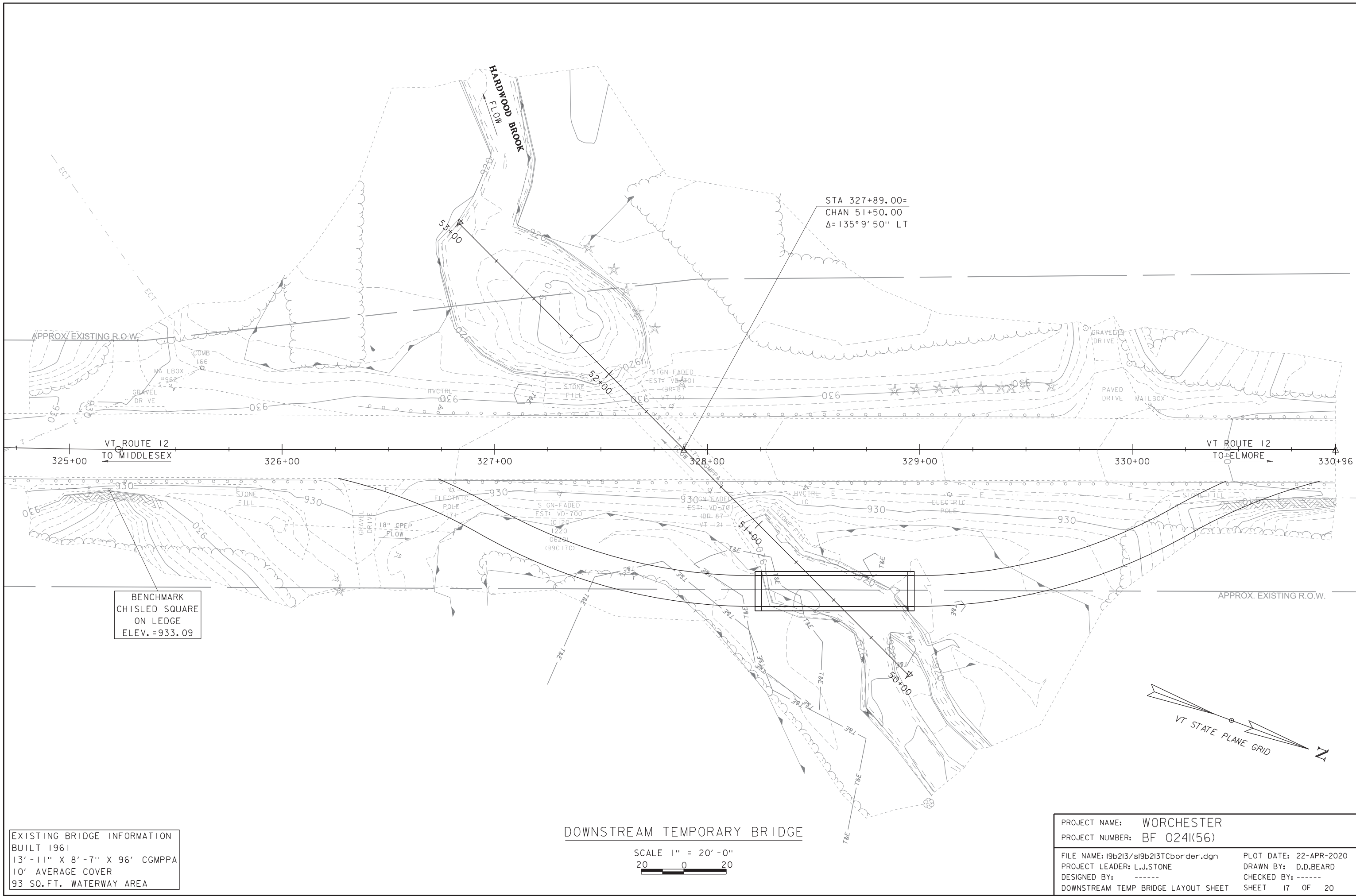

STA 327+89.00=
 CHAN 51+50.00
 $\Delta = 135^{\circ} 9' 50''$ LT

BENCHMARK
 CHISLED SQUARE
 ON LEDGE
 ELEV. = 933.09

EXISTING BRIDGE INFORMATION
 BUILT 1961
 13' - 11" X 8' - 7" X 96' CGMPPA
 10' AVERAGE COVER
 93 SQ.FT. WATERWAY AREA

DOWNSTREAM TEMPORARY BRIDGE

SCALE 1" = 20' - 0"
 20 0 20

PROJECT NAME: WORCHESTER
 PROJECT NUMBER: BF 0241(56)

FILE NAME: I9b213/s19b213Tcborder.dgn PLOT DATE: 22-APR-2020
 PROJECT LEADER: L.J.STONE DRAWN BY: D.D.BEARD
 DESIGNED BY: ----- CHECKED BY: -----
 DOWNSTREAM TEMP BRIDGE LAYOUT SHEET SHEET 17 OF 20

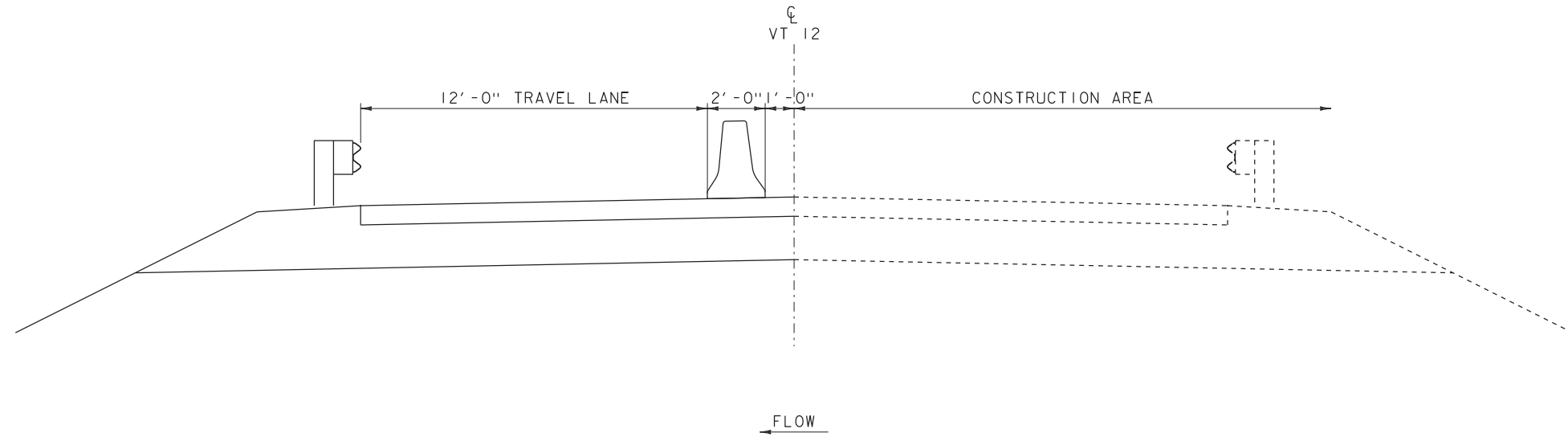

PHASE 1 TYPICAL SECTION

SCALE $\frac{3}{8}$ " = 1'-0"

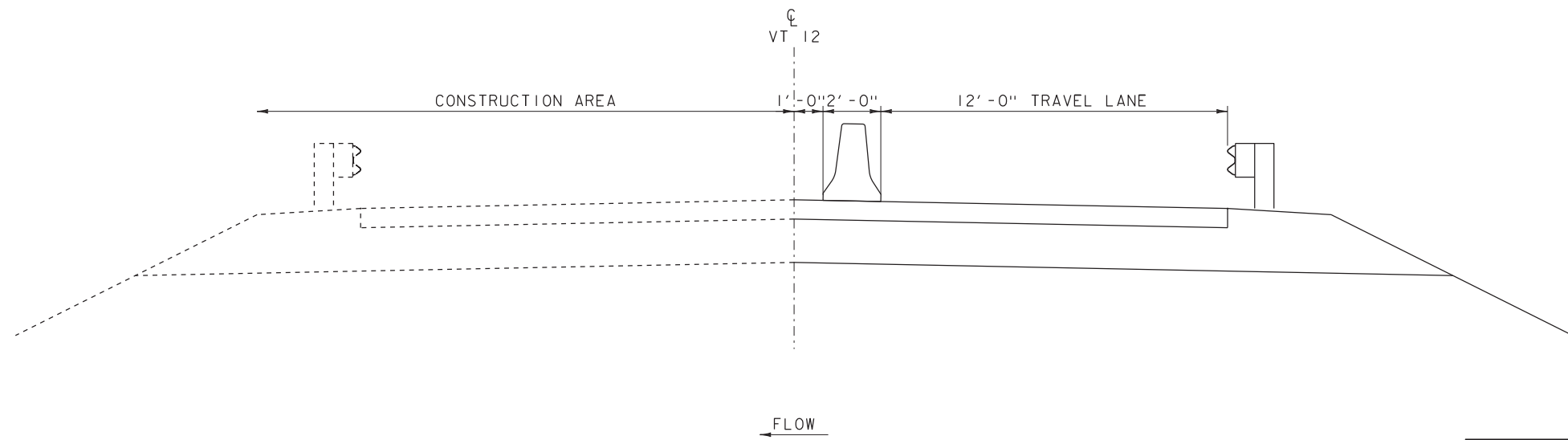

PHASE 2 TYPICAL SECTION

SCALE $\frac{3}{8}$ " = 1'-0"

PROJECT NAME:	WORCESTER	PLOT DATE:	22-APR-2020
PROJECT NUMBER:	BF 0241(56)	DRAWN BY:	D.D.BEARD
FILE NAME:	I9b213\sb9b213traffic.dgn	DESIGNED BY:	-----
PROJECT LEADER:	L.J.STONE	CHECKED BY:	-----
PHASING TYPICAL SECTIONS		SHEET	18 OF 20

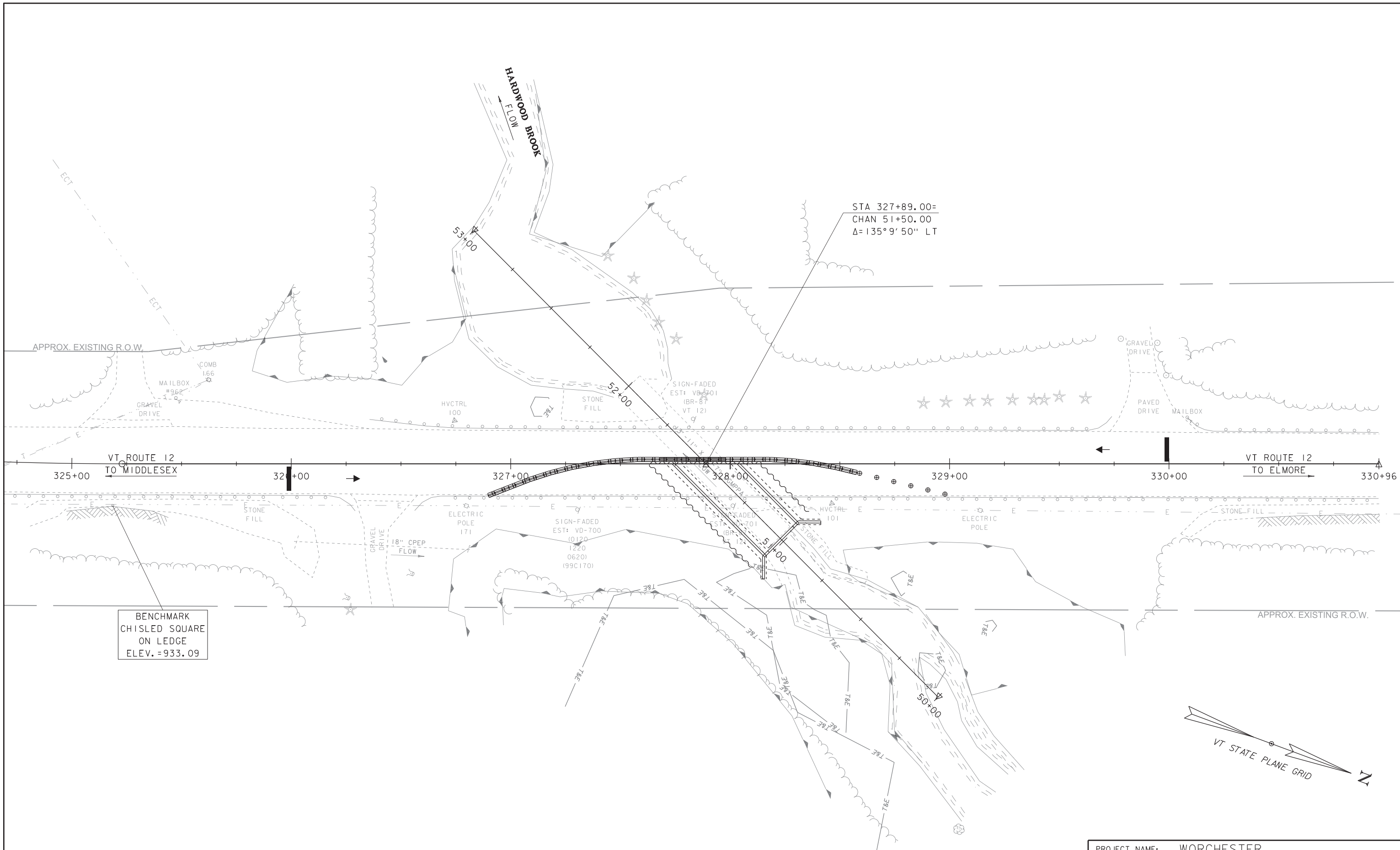

PHASE I LAYOUT

SCALE 1" = 20'-0"
 20 0 20

EXISTING BRIDGE INFORMATION
 BUILT 1961
 13'-11" X 8'-7" X 96' CGMPPA
 10' AVERAGE COVER
 93 SQ.FT. WATERWAY AREA

PROJECT NAME: WORCHESTER	PLOT DATE: 22-APR-2020
PROJECT NUMBER: BF 0241(56)	DRAWN BY: D.D.BEARD
FILE NAME: I9b213/sb213TCborder.dgn	CHECKED BY: -----
PROJECT LEADER: L.J.STONE	SHEET 19 OF 20
DESIGNED BY: -----	
PHASE I LAYOUT SHEET	

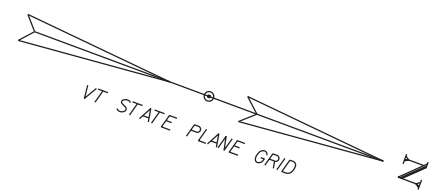

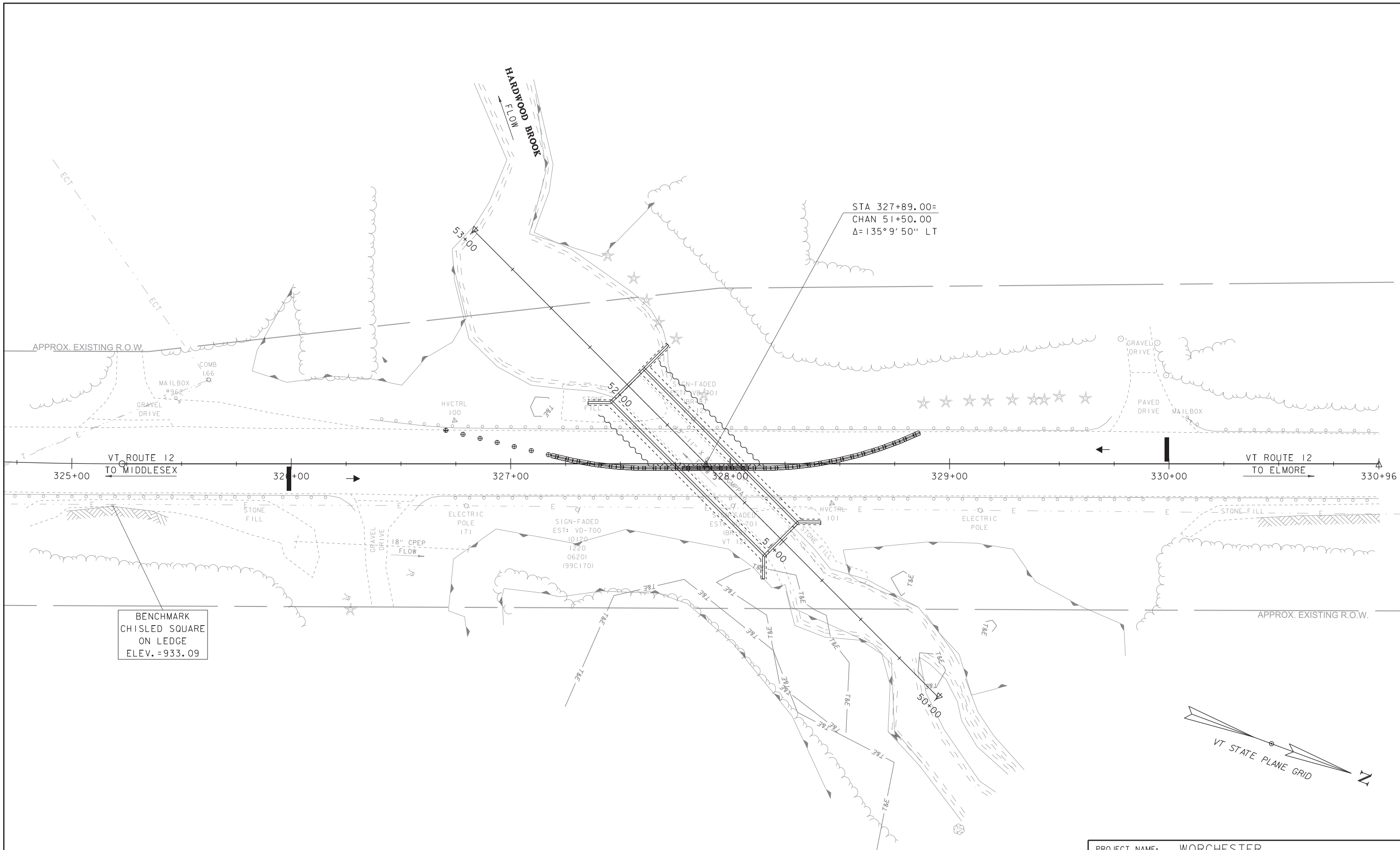

EXISTING BRIDGE INFORMATION
 BUILT 1961
 13'-11" X 8'-7" X 96' CGMPPA
 10' AVERAGE COVER
 93 SQ.FT. WATERWAY AREA

PHASE 2 LAYOUT

SCALE 1" = 20'-0"
 20 0 20

PROJECT NAME: WORCHESTER	PLOT DATE: 22-APR-2020
PROJECT NUMBER: BF 0241(56)	DRAWN BY: D.D.BEARD
FILE NAME: I9b213/s19b213Tcborder.dgn	CHECKED BY: -----
PROJECT LEADER: L.J.STONE	SHEET 20 OF 20
DESIGNED BY: -----	
PHASE 2 LAYOUT SHEET	