

**STATE OF VERMONT  
AGENCY OF TRANSPORTATION**

**Scoping Report**

**FOR  
WATERBURY IM CULV(109)**

**I-89 & US2 PID 68002 OVER SHARKEYVILLE BROOK**

June 30, 2023

---



# I. Contents

<b>I. Site Information</b> .....	<b>4</b>
Need .....	4
Traffic .....	4
Design Criteria.....	5
Inspection Report Summary .....	6
Hydraulics.....	7
Utilities .....	7
Right-Of-Way.....	7
Resources .....	7
<i>Archaeological:</i> .....	7
<i>Historic:</i> .....	8
<i>Natural Resources:</i> .....	8
<i>Hazardous Materials:</i> .....	9
<i>Stormwater:</i> .....	9
<b>II. Safety</b> .....	<b>10</b>
I-89 Crashes.....	10
US2 Crashes.....	10
Wildlife Collision Data .....	11
<b>III. Local Concerns</b> .....	<b>11</b>
<b>IV. Operations Concerns</b> .....	<b>11</b>
<b>V. Maintenance of Traffic</b> .....	<b>11</b>
Option 1: Off-Site Detour .....	11
<i>Lateral Slide</i> .....	13
<i>Prefabricated Bridge Units (PBU)</i> .....	13
<i>Installation Costs</i> .....	13
Option 2: Phased Construction .....	14
Option 3: Temporary Bridge .....	14
Option 4: On-Site Detour with Crossovers.....	15
Option 5: Sequential Excavation Tunneling (SET) Method .....	15
<b>VI. Structural Evaluations Discussion</b> .....	<b>16</b>
No Action.....	16
Rehabilitation.....	16
Alternative 1: Culvert Replacement with a New Buried Structure .....	16
a. <i>Structure Type and Alignment</i> .....	16
b. <i>Excavation Method</i> .....	17
Alternative 2: Replacement with an At-Grade Bridge .....	18

<i>e.</i> Superstructure Type .....	19
<i>f.</i> Substructure Type .....	19
<b>VII. Alternatives Summary .....</b>	<b>20</b>
<b>VIII. Cost Matrix.....</b>	<b>21</b>
<b>IX. Conclusion.....</b>	<b>23</b>
<b>X. Appendices.....</b>	<b>24</b>
Appendix A: Site Pictures .....	25
Appendix B: Town Map.....	35
Appendix C: Small Culvert Inspection Report .....	37
Appendix D: Preliminary Hydraulics Memo .....	40
Appendix E: Preliminary Geotechnical Memo .....	44
Appendix F: Resource ID Completion Memo .....	49
Appendix G: Natural Resources Memo.....	51
Appendix H: Archeology Memo .....	55
Appendix I: Historic Memo .....	60
Appendix J: Environmental Specialist Resource ID .....	66
Appendix K: Hazardous Sites Map .....	68
Appendix L: Stormwater Resource ID .....	70
Appendix M: Landscape Clearance Resource ID.....	72
Appendix N: Bolton Waterbury STP 2709(1) Wildlife Connectivity Study .....	75
Appendix O: Local Input.....	170
Appendix P: Operations Input.....	175
Appendix Q: Crash Data .....	178
Appendix R: Detour Maps .....	183
Appendix S: Plans .....	192

## I. Site Information

PID 68002 is located beneath US Route 2 and both barrels of I-89 at mile marker 67.49 and carries the Sharkeyville brook in the Town of Waterbury. The culvert crossing is approximately 0.18 miles eastbound along US2 from the intersection of US2 and Sharkyville Road. The existing conditions were gathered from a combination of a site visit, the small culvert inspection report, the Route Log, and the existing survey. See correspondence in the Appendix for more detailed information.

Roadway Classifications	I-89: Principal Arterial – Interstate, National Highway System US2: Minor Arterial, Federal Aid Highway System
Structure Type	CGMPP cross pipe
Culvert Span	5 feet
Culvert Length	385 feet
Fill Over Culvert	40 – 60 feet
Year Built	1961
Ownership	State of Vermont

### Need

PID 68002 extends under US2 and I89. The following is a list of deficiencies of PID 68002:

1. The culvert is listed as good condition but there are scattered perforations with heavy pitting and rust scaling throughout the invert. Settlement has occurred in the last third of the pipe at the outlet end. Considering that the pipe is hydraulically undersized it should be listed as fine to poor condition.
2. The existing culvert does not meet the state stream equilibrium standards for bankfull width resulting in an extremely undersized structure. This has caused increased debris blockage, ponding, and an approximate 150ft diameter scour hole at the outlet.
3. The existing culvert does not allow for wildlife passage in a highly rated area for habitat fragmentation and wildlife connectivity needs.
4. The existing culvert does not allow for aquatic organism passage (AOP).

In 2014-2016 there was a Wildlife connectivity study done along I-89 and US2 in Bolton and Waterbury (see Appendix N) aimed to determine what wildlife mortality is currently occurring and where wildlife is attempting to cross these fragmenting roadway features. The data from 24 trail cameras and winter tracking efforts showed that I-89 and US2 are indeed major fragmenting features that disconnects two of Vermont’s biggest habitat blocks of the Green Mountains, the Mt. Mansfield Habitat and Camels Hump habitat blocks. Based on the data collected in the study, it was clear that wildlife mortality continues along I-89 through this corridor. Furthermore, they identified the Sharkeyville culvert (PID 68002) as one of the two highest priority connection points for wildlife attempting to cross the roads at.

Because of the environmental importance of this area, the main goal of this project is to provide wildlife passage through the new structure. In doing so we will not only be providing safe passage for wildlife and reconnecting two of the largest habitat blocks in the state, but we will also be improving the vehicular safety of the roadway with less vehicle crashes being caused by wildlife crossing the road.

### Traffic

A traffic study of this site was performed by the Vermont Agency of Transportation. The traffic volumes are projected for the years 2027 and 2047.

Section	AADT		DHV		%T		%D		ADTT		ESALs	
	2027	2047	2027	2047	2027	2047	2027	2047	2027	2047	(2027~2047)	(2027~2047)
<b>I89 NB</b>	12,277	13,468	1,500	1,700	10.1	15.6	100	100	1,769	2,998	9,780,000	22,591,000
<b>I89 SB</b>	12,222	13,409	1,500	1,700	11.7	18.2	100	100	1,726	2,943	8,296,000	20,639,000
<b>US2</b>	5,514	6,049	775	850	3.9	5.3	52	52	430	651	2,418,000	5,426,000

### Design Criteria

The design standards for this project are the Vermont State Standards (VSS), dated October 22, 1997, A Policy on Geometric Design of Highways and Streets (Green Book), 7th Edition, and the VTrans Structures Design Manual, dated 2018. Minimum standards are based on the I-89 traffic volumes and a design speed of 70mph.

### I-89 Design Criteria:

Design Criteria	Source	Existing Condition	Minimum Standard	Comment
Approach Lane and Shoulder Widths	VSS Table 3.3	4'-12'-12'-10' (38')	4'-12'-12'-10' (38')	Jersey barrier in median
Bridge Lane and Shoulder Widths	VSS Table 3.3	NB: 6'-12'-12'-10' (40') SB: 8'-12'-12'-10' (42')	4'-12'-12'-10' (38')	Meets or exceeds minimum standards
Clear Zone Distance	VSS Table 3.4	Shielded by guardrail on both sides and jersey barrier in median	26' fill/16' cut	
Banking	VSS Section 3.13	Superelevated 6.6%	6-8% max	
Speed	VSS Section 3.3	65 mph (posted)	65 mph (min), 70mph (design)	
Horizontal Alignment	AASHTO Green book Table 3-10b	R = 1598'	R <sub>min</sub> = 2,790' @ e = 6.6%	
Vertical Grade	VSS Table 3.5	-2.78%, -3.05%	4% max for rolling terrain, 5% for mountainous terrain	
K Values for Vertical Curves	AASHTO Tables 3-35 & 3-37	K = 1648'	247' crest/181' sag	
Vertical Clearance Issues	VSS Section 3.8	N/A	N/A	
Stopping Sight Distance	AASHTO Green book Table 3-35 & 3-37	4178'	730'	
Bicycle/Pedestrian Criteria	VSS Table 3.14	No	No	No bike/ped access allowed on I-89
Hydraulics	VTrans Hydraulics Section	HW/D @ 1% AEP = 6.3ft; Water overtopping road before check event (0.5% AEP); Span: 5 feet	Minimum span = 18ft; Minimum 1ft freeboard at 1% AEP event; Provide AOP	
Bridge Railing (and Approach Railing)	Structures Design Manual Section 13.2	Steel beam guardrail and jersey barrier	TL-5	
Structural Capacity	Structures Design Manual Section 3.4.1	Structurally Sufficient	Design Live Load: HL-93	

The design standards for this project are the Vermont State Standards (VSS), dated October 22, 1997, A Policy on Geometric Design of Highways and Streets (Green Book), 7th Edition, and the VTrans Structures Design Manual, dated 2018. Minimum standards are based on an ADT of 5,514, a DHV of 775, and a design speed of 50 mph for a Minor Arterial.

**US2 Design Criteria:**

Design Criteria	Source	Existing Condition	Minimum Standard	Comment
Approach Lane and Shoulder Widths	VSS Table 4.3	11'4' (30)	11'5' (32')	Does not meet minimum standard
Bridge Lane and Shoulder Widths	VSS Table 4.3	11'4' (30)	11'5' (32')	Does not meet minimum standard
Clear Zone Distance	VSS Table 4.4	Shielded by guardrail on both sides and jersey barrier in median	26' fill/20' cut	
Banking	VSS Section 4.13	Superelevated 5.0%	6-8% max	
Speed	VSS Section 4.3	50 mph	50 mph	
Horizontal Alignment	AASHTO Green book Table 3-10b	R = 1,598'	R <sub>min</sub> = 2,040' @ e = 5.0%	
Vertical Grade	VSS Table 4.5	3.13%, 3.66%	5% max for rolling terrain, 6% for mountainous terrain	
K Values for Vertical Curves	AASHTO Tables 3-35 & 3-37	K = 1112	84 crest/96 sag	
Vertical Clearance	VSS Section 4.8	N/A	N/A	
Stopping Sight Distance	AASHTO Green book Table 3-35 & 3-37	HSSD = INF FT	425ft	
Bicycle/Pedestrian Criteria	VSS Table 4.14	4ft shoulders on US2 provided	4ft	
Hydraulics	VTrans Hydraulics Section	HW/D @ 1% AEP = 6.3ft; Water overtopping road before check event (0.5% AEP); Span: 5 feet	Minimum span = 18ft; Minimum 1ft freeboard at 1% AEP event; Provide AOP	
Bridge Railing (and Approach Railing)	Structures Design Manual Section 13.2	Steel beam guardrail	TL-4	
Structural Capacity	Structures Design Manual Section 3.4.1	Structurally deficient	Design Live Load: HL-93	

**Inspection Report Summary**

Inlet Condition	Unknown
Barrel Condition	Good
Outlet Condition	Good

This culvert is on the Small Culvert Inspection circuit and does not have any inspection comments to record. From a field visit conducted by the VTrans Scoping and Hydraulics teams on 5/3/22 the culvert looked to be in fine condition. The inlet was partially blocked by debris pile ups and the

invert is rusted throughout the invert. There may be additional damage to the barrel of the culvert, but the structure is so long and under 5ft in diameter that it is difficult to inspect the true condition of the structure without a remote controlled “culvert crawler” inspection device. There may be perforations along the invert or piping that we cannot see in the barrel.

## **Hydraulics**

The existing 5ft span does not meet the minimum bankfull width standard of 18ft, nor does it meet the current VTrans hydraulic standards of passing the 100-year (Q100) design storm event. This structure results in approximate HW/D ratio of 6.3 at the Q100 design event and 9.2 at the Q200 check event with possible water overtopping the roadway before Q200. The HY-8 modeling software utilized for existing conditions does not account for upstream storage. There appears to be enough storage for flood flow attenuation upstream, therefore the roadway may not experience overtopping during the check event.

The bridge is not located in a floodplain and does not increase the 100-year base flood elevations.

## **Utilities**

The existing utilities are shown on the Existing Conditions Layout Sheet, and are as follows:

Aerial: There are aerial facilities owned by Vermont Electric Cooperative (VELCO) and Consolidated Communications. VELCO has transmission lines that cross over US2 and I-89 approximately 675’ to the east from the culvert. Consolidated Communications have a single aerial line that runs on the north side of US2.

Underground: Consolidated Communications has an underground line that runs just off the edge of pavement on the north side of US2.

Municipal Utilities: There are no municipal water or sewer facilities within the project area.

Adjustments may need to be made to the existing utilities depending on the project scope of work.

## **Right-Of-Way**

Both US2 and I89 have ample state and historic ROW on both sides of the project limits. All parts of the structure are located within the existing Right-of-Way. The acquisition of additional Right-of-Way may be needed depending on the proposed design and temporary space needed for construction as the northern side of US-2 has less ROW than the southern side of I89.

## **Resources**

The environmental resources present at this project are shown on the layout sheets.

### ***Archaeological:***

An archaeological study was performed by the VTrans Environmental team and one archeological sensitive area was identified near the southern quadrant of the project area. Right along the edge of

the river there is one small terrace that sits on a higher ridge that is considered sensitive, but this area is well outside the areas likely to be impacted by the project.

***Historic:***

There are no historic properties on any properties adjacent to the ROW near the culvert.

***Natural Resources:***

Wetlands/Watercourses

Wetlands were delineated by the VTrans Environmental team in accordance with the US Corps of Engineers Wetland Delineation Methodologies. No wetlands were identified within the immediate vicinity of the culvert. There were wetlands outside the study area on the south side of I-89 to the east of the outlet of the culvert. An unnamed tributary of the Winooski River flows southerly beneath US Route 2 and both I-89 NB and SB lanes.

The unnamed tributary is regulated by the US Army Corps of Engineers and the Agency of Natural Resources. Project design alternatives need to avoid and minimize impacts to regulated waterways to the maximum extent practicable.

Wildlife Habitat

The project area is located along the spine of the Green Mountains. Interstate 89 (and traffic barrier) and US 2 (traffic and infrastructure) present a significant barrier to terrestrial and aquatic wildlife, separating the Northern Green Mountains from the Southern Green Mountains. This stretch of highway has been studied extensively (see Appendix N for Wildlife Connectivity Study) and species diversity is rich on both sides of the interstate. Protected lands are within this corridor of the interstate as well. The area is mapped within the VT Fish and Wildlife Bio Finder mapping as Highest Priority - Surface Water and Riparian Areas, Physical Landscape Diversity and Riparian and Wildlife Connectivity. Reestablishing connectivity to aquatic and terrestrial species should be considered on all replacement options.

Rare, Threatened and Endangered Species (R/T/E)

The VTrans Environmental team has queried the VT Fish and Wildlife Natural Heritage database. The historical occurrence of Fragrant fern (*Dyopteris fragrans*) a state listed rare (S2) plant is known to occur around the Bolton Falls. This species does not have regulatory protection unless Act 250 is triggered. There is a state listed (T) freshwater mussel within the Winooski River outside the project area.

I have queried the USFWS' Information, Planning and Conservation Planning website and two species were identified as potentially present in the action area: northern long-eared bat (*Myotis septentrionalis*), and the Monarch Butterfly (*Danaus plexippus*).

The project site is located within the summer range of the federally and state endangered northern long-eared bat (Agency of Natural Resources, 2022). Suitable summer habitat for this species includes trees  $\geq 3$  inches in diameter that contain exfoliating or furrowed bark, cracks, crevices and/or cavities (U.S. Fish and Wildlife Service, 2022). The northern long-eared bat has also been documented roosting in structures with suitable microclimates (Vermont Fish and Wildlife Department, 2016).



There are no known hibernacula or known maternity roosts within 1- mile of the project site for northern long eared bats. There is potentially suitable habitat adjacent to the Project site including potential roost trees. Depending on the scale of the project, acoustic surveys may need to be conducted to know if this species is present or not.

The Project also occurs within the summer range of the monarch butterfly, a species undergoing review for potential listing under the Endangered Species Act (USFWS, 2022). No critical habitat has been designated for this species.

#### Agricultural Soils / Floodplains

No mapped prime agricultural soils are present in the project area.

#### ***Hazardous Materials:***

According to the Vermont Agency of Natural Resources (VANR) Vermont Hazardous Sites List, the bridge is not located near any hazardous sites or within any areas of concern.

#### ***Stormwater:***

Depending on the scope and extent of the impacts to impervious surface, it seems likely that an Operational stormwater permit (OSW) will be required for this project. The trigger for a permit associated with this project would be if there is greater than 0.5ac of redevelopment (full depth reconstruction) of impervious surface. If an OSW permit is not triggered, but the area of disturbance is above 1 acre, that would trigger the need for a construction SW permit and also require the project to follow the TS4 "Gap" procedure and incorporate feasible post construction treatment measures. It will be useful early in the design to quantify the stormwater related impacts on a Project Impact Data Form to determine if jurisdiction for a permit will be triggered.

## II. Safety

### I-89 Crashes

Crashes on I-89 north and southbound from the last five-year period are shown to the right, encompassing the culvert project limits. Crashes are represented by black dots on the map. There have been 3 crashes near the project area in the last 5 years.

There is a High Crash Location Segment located just east of the project area:



High Crash Location Segment:

Route	Town	Mileage	# of Crashes	# of Fatalities	# of Injuries
I-89 NB	Waterbury	66.8 – 67.1	34	0	0

### High Crash Locations 2012-2016 Interactive Map

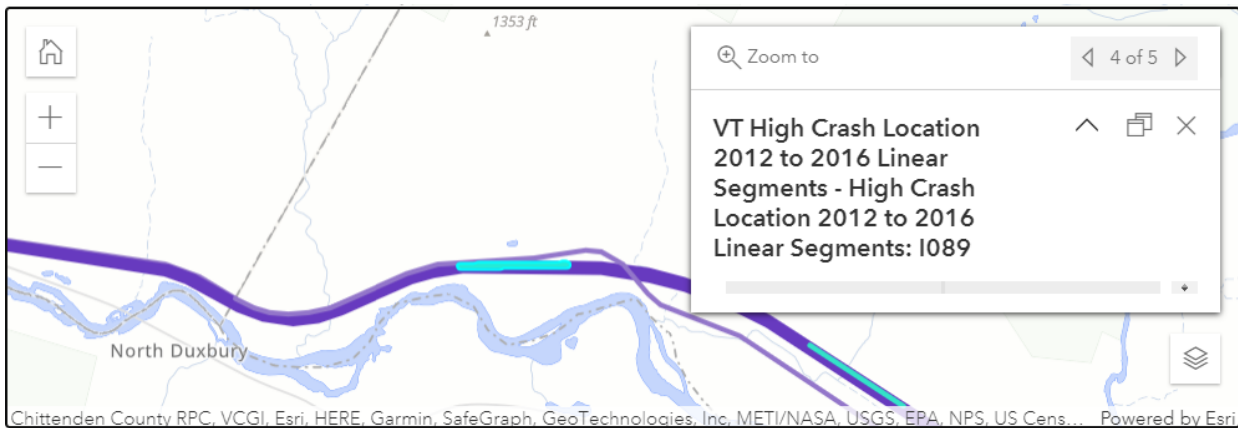

### US2 Crashes

Crashes on US2 from the last five-year period are shown to the right, encompassing the culvert project limits. Crashes are represented by black dots on the map.

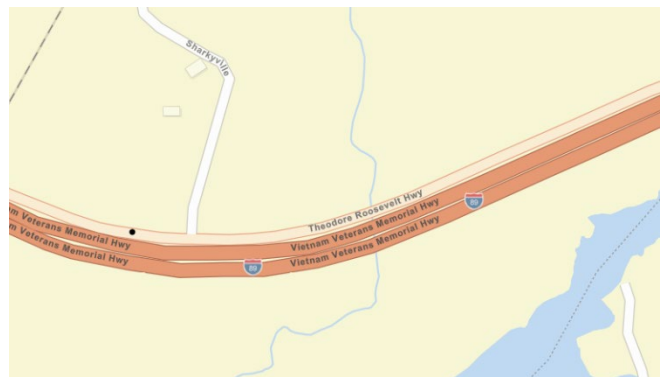

## **Wildlife Collision Data**

At the time of this writing, VTrans has just begun to collect statewide wildlife-vehicle-collision data. Therefore, this data is not readily available. However, this project falls in the middle of a very significant wildlife corridor where it is known that wildlife attempt to cross US2, I-89, and the Railroad.

Because of the environmental importance of this area one of the main goals of this project is to provide wildlife passage through the new structure. In doing so we will not only be providing safe passage for wildlife and reconnecting two of the largest habitat blocks in the state, but we will also be improving the vehicular safety of the roadway with less vehicle crashes being caused by wildlife crossing the road.

### **III. Local Concerns**

A local concerns questionnaire was sent to the town of Waterbury. No response has been received to date. There is a copy of the blank questionnaire in Appendix O.

### **IV. Operations Concerns**

An operations concerns questionnaire was sent to the VTrans maintenance District 6. No response has been received to date. There is a copy of the blank questionnaire in Appendix P.

### **V. Maintenance of Traffic**

The Vermont Agency of Transportation reviews each new project to determine suitability for the Accelerated Bridge Program, which focuses on faster delivery of construction plans, permitting, and Right of Way, as well as faster construction of projects in the field. One practice that will help in this endeavor is closing bridges for portions of the construction period, rather than providing temporary bridges. In addition to saving money, the intention is to minimize the closure period with faster construction techniques and incentives to contractors to complete projects sooner. The Agency will consider the closure option on most projects where rapid reconstruction or rehabilitation is feasible. The use of prefabricated elements in new bridges will also expedite construction schedules. This can apply to decks, superstructures, and substructures. Accelerated Construction should provide enhanced safety for the workers and the travelling public while maintaining project quality. The following options have been considered:

#### **Option 1: Off-Site Detour**

This option would close the road and reroute traffic onto an offsite detour. Since the culvert is located under a State Highway and a federal interstate, a detour will likely not be a favorable option for this project. The culvert is located on one of the longer stretches between exits and in one of the highest traveled areas of I-89.

The shortest possible detour route for US2 and I-89 traffic is the southern detour route which has an end-to-end distance of 66.6 miles and adds 37.0 miles to the through route. This route is as follows:

1. If travelers are approaching east of the project on US2 in Waterbury, they will have to use the traffic circle in Waterbury to continue onto US2 traveling southeast, then turn onto VT100 and travel south. Travelers should continue driving south on VT100 until they get to Irasville where they turn onto VT17 and travel west until Starksboro where they turn onto VT116 and travel north to VT Route 2A, back to US Route 2.
  - a. Through distance = 14.8 miles
  - b. detour distance = 51.8 miles
  - c. added distance = 37.0 miles
  - d. end-to-end distance = 66.6 miles
2. If travelers are approaching east of the project in Richmond, the same route applies but in reverse order.
3. If travelers are approaching the project on I-89 from either direction, the same route for US2. Travelers approaching the project from the east on I-89 should take Exit 10 in Waterbury and travelers approaching from the west on I-89 should use Exit 12 in Williston and follow the US Route 2 detour.

An alternative northern detour for both US2 and I89 has an end-to-end distance of 71.6 miles and adds 42.0 miles to the through route. This route is as follows:

1. If travelers are approaching east of the project on US2 in Waterbury, they will have to use the traffic circle in Waterbury to travel northeast on VT Route 100 to VT Route 108, VT Route 15, VT Route 289, and VT Route 117, back to US Route 2.
  - a. Through distance = 14.8 miles
  - b. detour distance = 56.8 miles
  - c. added distance = 42.0 miles
  - d. end-to-end distance = 71.6 miles
2. If travelers are approaching east of the project in Richmond, the same route applies but in reverse order.
3. If travelers are approaching the project on I-89 from either direction, the same route for US2. Travelers approaching the project from the east on I-89 should take Exit 10 in Waterbury and travelers approaching from the west on I-89 should use Exit 11 in Richmond and follow the US Route 2 detour.

An alternative local bypass detour route for both US2 and I89 has an end-to-end distance of 32.7 miles and adds 3.1 miles to the through route. This would not be a signed detour route, but local vehicles may use this route if US Route 2 is closed during construction. This route is as follows:

1. If travelers are approaching east of the project on US2 in Waterbury, they will have to use the traffic circle in Waterbury to continue onto US2 traveling southeast, turn onto Winooski St, then turn onto River Rd and travel northwest continuing on River Rd/Duxbury Rd until turning on Cochran Rd in Jonesville and then turning onto US2. From there travelers continue onto US2 through Richmond and beyond or get back onto I-89 at Exit 11 in Richmond.
  - a. Through distance = 14.8 miles
  - b. detour distance = 17.9 miles
  - c. added distance = 3.1 miles
  - d. end-to-end distance = 32.7 miles
2. If travelers are approaching east of the project in Richmond, the same route applies but in reverse order.
3. If travelers are approaching the project on I-89 from either direction, the same route for US2. Travelers approaching the project from the east on I-89 should take Exit 10 in Waterbury and travelers approaching from the west on I-89 should use Exit 11 in Richmond and follow the detour.

It is recommended that a detour only be utilized for brief closure periods during off peak hours, such as nights or weekends, in order to rapidly replace the deck or superstructures. The methods available to replace a deck or superstructure during a short closure period include: lateral slide or prefabricated bridge elements. Each of these methods is discussed briefly below.

### ***Lateral Slide***

A lateral slide consists of constructing an entire superstructure adjacent to the location where it is intended and physically pushing or pulling the structure into its design location along lubricated rails. This allows traffic to be maintained on the existing structure while construction of the bridges takes place. Traffic would then be detoured for approximately 3 days while the existing bridge is removed and the new bridge is moved into place.



[Images from “Accelerated Bridge Construction - Experience in Design, Fabrication and Erection of Prefabricated Bridge Elements and Systems” from FHWA (2011).]

### ***Prefabricated Bridge Units (PBU)***

Another method of constructing the bridge in a safer and less restricted environment is to prefabricate portions of the bridge structure and deliver those pieces to the construction site to be joined together to form the bridge. These bridge superstructure pieces are referred to as Prefabricated Bridge Units, or PBUs. Many substructure pieces can be prefabricated as well and lifted into place before the PBUs are placed.



Using rapid setting concrete for the joint closure pours, the closure period can be reduced to 3 days per bridge for this method of superstructure replacement as well.

### ***Installation Costs***

The baseline method of installing the superstructure is using a crane to lift the PBUs into place. These costs are included in the baseline bridge costs. The extra engineering and temporary supports required for a lateral slide are approximately \$150,000 per bridge.

A map of the detour routes can be found in Appendix Q.

*Advantages:* This option would eliminate the need for a temporary bridge, which would significantly decrease cost and time of construction. This option would not require the need to obtain rights from adjacent property owners for a temporary bridge. This is the safest traffic control option since the traveling public is removed from the construction site.

*Disadvantages:* Traffic flow would not be maintained through the project site during construction. With I-89 being closed between Exits 10 and 11 for about a 15-mile stretch all traffic is usually detoured using US2 which is about a 10-minute difference in travel time and approximately 15.3 miles between exits. However, with this project, US2 would also be detoured along with I-89 leaving a southern detour route option using VT-17. This detour would significantly impact traffic since I-89 has an DHV of 1500 and with significant truck traffic at 11.7%. This detour has a distance of 51.8 miles and would add about an hour of travel time to the journey.

## **Option 2: Phased Construction**

Phased construction is the maintenance of one-way alternating traffic on the existing road while building one lane at a time of the proposed structure. This allows keeping the road open during construction, while having minimal impacts to adjacent property owners and environmental resources. The project begins with traffic being constricted to one lane, while work is done on the other. After completion of improvements to the first lane, traffic is switched to the completed lane and work proceeds on the second lane. Traffic flow is constant, although delayed due to slower speeds in the work zone. In the case of Interstate bridges, phasing is usually appropriate only for repairs or replacement of deck and/or railing. For I-89 NB and SB, the DHV volume of vehicles per hour is above the 1,250 vehicles per hour cutoff that guidance allows for one lane during peak hours, therefore phasing should be considered for a reasonable period of time without needing to reopen both lanes but should be limited in order to reduce traffic congestion. Periodic short-term lane closures or shifts on US Route 2 may be necessary to provide access to crews working on the superstructures from below. These shifts or closures would not be advised during peak hours.

*Advantages:* Traffic flow is maintained through the corridor during the project. Phasing the work allows the work to proceed one lane at a time without the expense of a temporary bridge or crossovers and without the inconvenience of a closure and detour.

*Disadvantages:* Compared to a closure and detour or a temporary bridge scenario, it takes longer and costs more to construct a bridge project in phases because some of the construction tasks have to be performed multiple times and cannot be performed concurrently. Additional permit requirements may come into play. The safety risks for both workers and travelers are also increased due to the close proximity to each other. Some structural qualities, such as joints, demand more coordination time and may suffer in quality as well. Periodic lane closures outside of peak hours on US Route 2 may be required.

## **Option 3: Temporary Bridge**

From a constructability standpoint, a temporary bridge could be placed either upstream or downstream of the existing structure. The culvert is located in a rural area with a gravel drive off of US 2 about 325ft east of the existing structure. A temporary bridge on the upstream (northern) or downstream (southern) side of the roadways would have impacts to wetlands and the gravel drive if the temporary bridge was built near the existing brook. There are buried communications and telephone lines that run just off the edge of pavement on the north side of US 2 side and arial transmission lines that cross over US2 and I-89 about 675-ft to the east. If the temporary bridge were placed on the upstream side, the utilities would need to be relocated.

Additional costs would be incurred to construct a temporary bridge, including the cost of fill for the approaches and the bridge itself, installation and removal of the temporary bridges and approaches, and restoration of the disturbed area.

If a temporary bridge is chosen as the preferred method of traffic control, based on the traffic volumes and site conditions, it should be a two-lane bridge with alternating traffic to minimize impacts to surrounding resources. See the Temporary Bridge Layout Sheets in Appendix R.

*Advantages:* A temporary bridge maintains traffic along the existing corridor during construction.

*Disadvantages:* There are extra costs associated with constructing or launching temporary bridges. Changes in traffic patterns can increase the probability of accidents and the increased time associated with constructing temporary approaches and launching the temporary bridges puts the construction workers at increased risk for accidents. In order to minimize the length of median affected by the temporary roadwork, the design speed should probably be reduced to more safely allow vehicles to navigate the temporary roadway. This decrease in speed would cause traffic delays.

#### **Option 4: On-Site Detour with Crossovers**

Another method for maintaining traffic on parallel structures with multiple lanes of unidirectional traffic is creating a crossover in the median before and after the structures to get all traffic off one structure and on to the parallel structure. This option is rarely available for most projects, because most non-interstate structures in Vermont do not have parallel bridges. The possibilities on interstates may even be limited based on site distance, traffic patterns or obstructions in the median.

There is adequate site distance and there are no obstructions other than the median barrier. Additionally, the elevation of the northbound and southbound lanes are nearly equal, making this a good candidate for crossovers.

#### **Option 5: Sequential Excavation Tunneling (SET) Method**

Utilizing a tunnel as temporary support under I89 and US2 to install a precast concrete arch as a permanent structure. This would allow for continual adjustment of line and grade and any obstructions (trees, boulders, etc.) would be easily handled. In some cases, this method can reduce risks associated with uncertainty of jacking which then can potentially save money on the cost of jacking.

Factors that need to be considered and designed for this method would be ground types, excavation geometry, excavation support design, groundwater/ground stress levels in the project area, and vertical deformation studies before and after construction.

*Advantages:* This method would allow traffic to continue to flow on both US2 and I89 throughout the duration of construction.

*Disadvantages:* This method is not used often in Vermont. The design of the tunneling is very complex and can be expensive. This option could only be used for select buried structure design alternatives and would not be used for a bridge replacement. From the preliminary geotechnical scoping report, it is likely that there are cobbles and large boulders within the fill underneath the roadways which would make tunneling difficult.

## VI. Structural Evaluations Discussion

### No Action

This alternative is not recommended. The culvert needs to be upsized and the stream and watershed around this structure will continue to deteriorate if no action is taken. This area is a major area for wildlife crossing and there is a significant amount of wildlife activity around this area. US2 and I-89 are both major habitat barriers at this location and right in the middle of a major wildlife corridor between Mt. Mansfield and Camels Hump state forests. These roadways have caused habitat fragmentation between these habitat blocks and in order to connect them the existing culvert here needs to be replaced with a new structure large enough to allow for adequate wildlife passage.

No cost estimate has been provided for this alternative since there are no immediate costs.

### Rehabilitation

This alternative is not recommended. Typically, a culvert rehabilitation option includes minimal amounts of work necessary to address maintenance needs, correct substandard features, and extends the useful life of the culvert. In this case rehabilitation options such as invert repair, pipe liner options, or embankment/channel improvements are not an adequate solution since they would reduce the hydraulic capacity of the already hydraulically inadequate structure and would not meet the needs of the project.

### Alternative 1: Culvert Replacement with a New Buried Structure

This option involves removing the existing Corrugated Galvanized Metal Plate Pipe and replacing it with a new buried structure. Per the preliminary hydraulics report, the new structure shall be a minimum span of 18 feet wide to meet bankfull width and a minimum clear height of 6 feet, providing a 108 square foot waterway area. With a range of 40-60 feet worth of fill above the culvert across the length of the pipe, there would need to be a considerable amount of earthwork to gain access to the structure. Due to the amount of flow in the stream and duration of construction, the existing pipe will need to maintain flow of the stream throughout construction of the new structure. Any new structure is anticipated to incorporate flared wingwalls at the inlet and outlet to make a smooth transition between the channel and the culvert. The final conditions of US2 and I-89 will match the existing roadways for all alternatives. The various subsets of this Alternative which were explored include: structure type, structure alignment, and excavation method.

#### *a. Structure Type and Alignment*

To maintain a minimum of 108 square feet of waterway area, the replacement culvert would likely be either a 4-sided box culvert or a 3-sided structure. The new stream bottom will need to be built using E-stone, Type III through any structure due to the significant aggradation upstream of the structure and channel/bank erosion downstream of the structure. The existing alignment of the culvert will be maintained as to not run into the dam downstream at Bolton falls. Keeping the alignment, the same with a new structure will most likely be the easiest, least impacting, and least expensive to construct.

**4-Sided Box Culvert:** This structure type would provide additional protection against scour and undermining due to the structure having a concrete bottom instead of just earth. Installation would also be easier as the structure would not require separate footings to be cast prior to placing the structure. The 4-sided box would be placed on-alignment, but the length would be shortened by approximately 20ft on each side of the structure to better fit



the topography of the site. This may require minor bank stabilization up and downstream and stream realignment work downstream.

**3-sided Rigid Frame:** This structure type would be an open bottom structure that would span over the existing structure, resulting in the final alignment of the structure being the same as its current location. Compared to a 4-sided structure, this structure would require additional excavation to install foundations. If phased construction is used, the downstream portion of the new structure would be installed first, to allow the existing culvert portion beneath the new segment to be removed prior to backfilling the embankment.

**Long Span Precast Concrete Arch:** This structure type would be an open bottom structure founded on piles that would span over the existing structure, resulting in the final alignment of the structure being the same as its current location. The arch span should be maximized in order to get the foundations placed as high as possible on the new channel banks. With the arch placed high on the side slopes, the amount of fill over the structure would be reduced. Compared to a 4-sided structure, this structure would require additional excavation to install foundations. If this option is chosen as the recommended alternative, designers should consider daylighting between structures if possible.

#### *b. Excavation Method*

Three primary methods of excavation could be used to construct the new structure: either using a braced excavation method, open cutting while maintaining 1.75H:1V side slopes, or using trenchless excavation method. Using a braced excavation method at this site will result in sheeting being placed east-west across the roadway in two rows and braced between the rows of sheeting. Braced excavation will reduce the amount of impacted area and the amount of soil that will need to be removed from the site, but the unit cost of excavation will likely be more due to access constraints.

The open cut excavation will allow for open cutting the entire embankment at once by incorporating the use of a temporary bridge or phased construction with a temporary earth support system (TESS) placed in the median. Median crossovers outside the limits of the TESS, would be utilized to maintain traffic. Due to the height of excavation, the TESS would need to incorporate tie backs into the embankments with either soil anchors or deadmen, increasing the cost in comparison to typical cantilever sheeting.

The trenchless excavation method will allow for a new structure to be installed without affecting traffic on US-2 or I-89. The conventional trenchless excavation method of jack and bore, would be able to be used but are typically used for pipes less than 6-ft diameter. Installing a 18-ft minimum span structure to meet bankfull width requirements would come with a significant cost premium, or even be unavailable for the area. Installing twin 9-ft culverts adjacent to each other could be used to meet the bankfull width requirement, but this is not a favored solution hydraulically due to the twin culverts having an increased chance of collecting debris therefore increasing the flow into the opposing culvert. The twin culverts would not be a preferred solution for the wildlife or Aquatic Organism passage since the opening is split in two.

The primary challenge with open cutting the embankment is the magnitude of soil that needs to be moved off site and returned to backfill. The site does not have a place to store significant volumes of fill without a significant amount of clearing or impacts to wetlands or residential properties.

*Advantages:* This alternative provides the lowest upfront cost for a replacement structure and

minimal future maintenance costs, while maintaining the minimum required hydraulic opening.

*Disadvantages:* Large amounts of excavation and backfilling is required, especially if open cutting the embankment. Limited onsite storage areas would require temporary offsite storage or reuse on another project if possible.

*Maintenance of Traffic:* All structural options allow phased construction with the use of median crossovers, temporary bridge, or an off-site detour. The trenchless excavation method can only be used for the four-sided box culvert option.

## **Alternative 2: Replacement with an At-Grade Bridge**

This alternative would replace the existing culvert with three integral abutment bridges. Due to the existing depth of the stream in relation to I-89 and US2, the minimum allowable structure depth would not be a concern.

### *a. Alignment*

The structure is located under a horizontal curve along VT Route 2 and I-89. The current alignment is well aligned with the waterway so the bridges will be designed to be constructed on alignment.

### *b. Bridge Width*

The two interstate structures would match the typical section required through the corridor, two 12-ft lanes, 4-ft inside shoulders and a 10-ft outside shoulders. The remaining state route structure for US2 would match the typical section of two 11-ft lanes, and two 5ft shoulders.

### *c. Bridge Length and Skew*

The existing structure has a span of 5-feet and a skew of about 12 degrees. This clear span does not meet the minimum bankfull width of 18-feet required for hydraulics. The structure lengths would each be approximately 215' to maintain 1.75H:1V for slopes from the stream and the minimum required bankfull width of 18- ft. The skew of 12 degrees is recommended to match the existing conditions of the channel.

### *d. Structure Type*

*Option 1 – New Two-Span Bridges:* This option would replace the existing culvert with three two-span steel girder superstructure bridges with cast-in-place composite concrete decks. This structure type is not preferred as it would have one pier constructed directly in the path of the stream. This would not only be not preferable for wildlife using this structure for passage, but it would also not be favorable hydraulically as it would increase scour around the pier compared to a three-span design. This superstructure type would meet the minimum hydraulic requirements.

*Option 2 – New Three-Span Bridges:* This option would replace the existing culvert with three three-span steel girder superstructure bridges with cast-in-place composite concrete decks. This structure type is preferred as it has two piers that will be set back on the side slopes out of the waterway area. With this design, wildlife will be able to pass underneath the structure in an un-obstructed path and scour will not be as big of a concern.

*e. Superstructure Type*

The most economical superstructure type for this span is a steel girder superstructure with a cast-in-place composite concrete deck. If an offsite detour is chosen to be the preferred method of traffic control, then accelerated bridge construction methods would be recommended. These are explained in section III: Maintenance of Traffic of this report and could include a lateral slide, self-propelled Modular Transporters, or prefabricated elements. The most common type of prefabricated superstructure elements that can satisfy a 215-foot maximum span length are Prefabricated Precast Bridge Units (PBUs) or prefabricated precast deck slabs on steel beams.

*f. Substructure Type*

The preliminary geotechnical report indicates that new abutments and piers could be founded on integral abutments, spread footings bearing on suitable foundation soils, or deep foundations such as driven piles or drilled shafts extending to bedrock. Sufficient subsurface information should be obtained in design to verify the in-situ conditions and determine the best foundation type. The preliminary geotechnical report can be found in Appendix D.

*g. Maintenance of Traffic*

Traffic could be maintained on an offsite detour, a temporary bridge, crossovers, or with phased construction.

*Advantages:* Three-Span bridges would be preferred for hydraulic and wildlife passage options to avoid placing a pier in the middle of the stream crossing.

*Disadvantages:* All bridge replacement options would be expensive with the cost of steel and the construction costs. Large amounts of excavation and backfilling are required, especially if open cutting the embankment. Limited onsite storage areas would require temporary offsite storage or reuse on another project if possible. Overall constructing new bridges at this site would take longer to complete and would impact traffic greatly.

## **VII. Alternatives Summary**

Based on the existing site conditions, bridge condition, and recommendations from hydraulics, there are several viable alternatives:

- Alternative 1a: Culvert Replacement with a New Buried Structure and Traffic Maintained by Offsite Detour
- Alternative 1b: Culvert Replacement with a New Buried Structure and Traffic Maintained by Phased Construction
- Alternative 1c: Culvert Replacement with a New Buried Structure and Traffic Maintained by Temporary Bridge
- Alternative 1d: Culvert Replacement with a New Buried Structure and Traffic Maintained by SET Method
- Alternative 2a: Full Structure Replacement with New At-Grade Bridges and Traffic Maintained by Offsite Detour
- Alternative 2b: Full Structure Replacement with New At-Grade Bridges and Traffic Maintained by Phased Construction
- Alternative 2c: Full Structure Replacement with New At-Grade Bridges and Traffic Maintained by Temporary Bridge

**VIII. Cost Matrix<sup>1</sup>**

Waterbury IM CULV(109)		Do Nothing	Alternative 1						Alternative 2						
			Full Structure Replacement with a Buried Structure						Full Structure Replacement with a Conventional Steel Bridge						
			4-Sided Precast Cox Culvert			Long-Span Precast Concrete Arch			2-Span Bridges			3-Span Bridges			
			On-Alignment			On-Alignment			On-Alignment			On-Alignment			
			a. Offsite Detour	b. Median Crossovers with Phased Construction	c. Temporary Bridge	d. Offsite Detour	e. Median Crossovers with Phased Construction	f. Temporary Bridge	a. Offsite Detour	b. Median Crossovers with Phased Construction	c. Temporary Bridge	d. Offsite Detour	e. Median Crossovers with Phased Construction	f. Temporary Bridge	
COST	Bridge Cost	\$0	\$4,800,613	\$5,520,704	\$4,800,613	\$6,698,906	\$6,429,393	\$5,590,776	\$18,976,800	\$21,823,300	\$18,976,800	\$12,183,600	\$14,011,100	12,183,600	
	Removal of Structure	\$0	\$192,500	\$221,375	\$192,500	\$192,500	\$221,375	\$192,500	\$0	\$0	\$0	\$0	\$0	0	
	Roadway	\$0	\$340,657	\$771,990	\$501,037	\$261,867	\$599,040	\$380,723	\$1,214,000	\$3,480,000	\$2,421,000	\$878,000	\$2,993,000	2,082,000	
	Maintenance of Traffic	\$0	\$175,300	\$3,046,600	\$1,985,790	\$221,300	\$3,046,600	\$1,985,790	\$275,300	\$3,046,600	\$2,185,790	\$278,300	\$3,046,600	2,185,790	
	Construction Costs	\$0	\$5,509,069	\$9,560,670	\$7,479,939	\$7,374,573	\$10,296,407	\$8,149,790	\$20,466,100	\$28,349,900	\$23,583,590	\$13,339,900	\$20,050,700	16,451,390	
	Construction Engineering & Contingencies	\$0	\$1,101,814	\$1,912,134	\$1,495,988	\$1,474,915	\$1,750,389	\$1,629,958	\$3,069,915	\$5,669,980	\$3,537,539	\$2,000,985	\$4,010,140	2,467,709	
	Accelerated Premium	\$0	\$0	\$0	\$0	\$0	\$0	\$0	\$0	\$0	\$0	\$0	\$0	\$0	0
	Total Construction Costs w CEC	\$0	\$6,610,883	\$11,472,804	\$8,975,927	\$8,849,488	\$12,046,797	\$9,779,747	\$23,536,015	\$34,019,880	\$27,121,129	\$15,340,885	\$24,060,840	18,919,099	
	Preliminary Engineering	\$0	\$1,101,814	\$1,912,134	\$1,495,988	\$1,474,915	\$1,544,461	\$1,629,958	\$2,046,610	\$5,669,980	\$4,716,718	\$1,333,990	\$4,010,140	3,290,278	
	Right of Way	\$0	\$0	\$0	\$0	\$0	\$0	\$0	\$0	\$0	\$0	\$0	\$0	\$0	0
	<b>Total Project Costs</b>	<b>\$0</b>	<b>\$7,712,697</b>	<b>\$13,384,938</b>	<b>\$10,471,915</b>	<b>\$10,324,403</b>	<b>\$13,591,258</b>	<b>\$11,409,705</b>	<b>\$25,582,625</b>	<b>\$39,689,860</b>	<b>\$31,837,847</b>	<b>\$16,674,875</b>	<b>\$28,070,980</b>	<b>22,209,377</b>	
Annualized Costs	\$0	\$77,127	\$133,849	\$104,719	\$103,244	\$135,913	\$114,097	\$255,826	\$396,899	\$318,378	\$166,749	\$280,710	\$222,094		
SCHEDULEING	Project Development Duration	N/A	2 years	2 years	2 years	2 years	2 years	2 years	4 years	4 years	4 years	4 years	4 years	4 years	
	Construction Duration	N/A	4 months	8 months	8 months	4 months	8 months	8 months	10 months	16 months	16 months	10 months	16 months	16 months	
	Closure Duration (If Applicable)	N/A	Construction duration	NA	NA	Construction duration	NA	NA	Construction duration	NA	NA	Construction duration	NA	NA	
ENGINEERING	Typical Section - I-89 Roadway (feet)	38	38	38	38	38	38	38	38	38	38	38	38	38	
	Typical Section - US2 Roadway (feet)	30	32	32	32	32	32	32	32	32	32	32	32	32	
	Geometric Design Criteria	Minimum standard width for I-89 but does not meet minimum standard for US2	Meets Minimum Standard			Meets Minimum Standard			Meets Minimum Standard			Meets Minimum Standard			
	Traffic Safety	No Change	Improved	Improved	Improved	Improved	Improved	Improved	Improved	Improved	Improved	Improved	Improved	Improved	Improved
	Alignment Change	No Change	No Change	No Change	No Change	No Change	No Change	No Change	No Change	No Change	No Change	No Change	No Change	No Change	No Change

<sup>1</sup> Costs are estimates only, used for comparison purposes.

	Bicycle Access	No Change	Yes	Yes	Yes	Yes	Yes	Yes	Yes	Yes	Yes	Yes	Yes	Yes		
	Pedestrian Access	No Change	No Change	No Change	No Change	No Change	No Change	No Change	No Change	No Change	No Change	No Change	No Change	No Change		
	Hydraulics	No Change	Minimum BFW and freeboard			Minimum BFW and freeboard			Minimum BFW and freeboard			Minimum BFW and freeboard				
	Utilities	No Change	No Change	No Change	No Change	No Change	No Change	No Change	No Change	No Change	No Change	No Change	No Change	No Change		
WILDLIFE CONNECTIVITY	Openness Ratio		Openness Ratio	Openness Ratio			Openness Ratio			Openness Ratio			Openness Ratio			
	Structure can pass:	AOP	N/A	No	Yes	Yes	Yes	Yes	Yes	Yes	Yes	Yes	Yes	Yes	Yes	
		Herpeofauna	0.005 - 0.02	No	No, length should be <200' if no natural lighting			No, length should be <200' if no natural lighting			Yes, 67.6, I-89 bridges (104 for US2 bridge)			Yes, 67.6, I-89 bridges (104 for US2 bridge)		
		Small mammals	0.008 - 0.016	No	No, length should be <250' if no natural lighting			No, length should be <250' if no natural lighting			Yes, 67.6, I-89 bridges (104 for US2 bridge)			Yes, 67.6, I-89 bridges (104 for US2 bridge)		
		Medium mammals	> 0.4	No	0.55, Yes			0.7, Yes			Yes, 67.6, I-89 bridges (104 for US2 bridge)			Yes, 67.6, I-89 bridges (104 for US2 bridge)		
		Large mammals	> 0.9	No	0.55, No			0.7, No			Yes, 67.6, I-89 bridges (104 for US2 bridge)			Yes, 67.6, I-89 bridges (104 for US2 bridge)		
OTHER	ROW Acquisition		No Change	No	No	Yes	No	No	Yes	No	No	Yes	No	No	Yes	
	Road Closure		No Change	Yes	No	No	Yes	No	No	Yes	No	No	Yes	No	No	
	Design Life		N/A	100	100	100	100	100	100	100	100	100	100	100	100	

## IX. Conclusion

**Alternative 1b is recommended:** replacement of the existing culvert with new Long Span Precast Concrete Arch structures while maintaining traffic on crossovers by phased construction.

### Structure:

The existing culvert is 62 years old and looks to be in fine condition from a site visit done in early May of 2022. The culvert inlet is prone to debris blockage and the outlet of the pipe is perched about 1.5ft. There may be damage to the barrel of the culvert, but the structure is so long and under 5ft in diameter that it is difficult to inspect the true condition of the structure without a remote controlled “culvert crawler” inspection device.

The structure does not meet the current hydraulic standards, nor does it meet the state stream equilibrium standards for bankfull width. Because of the perched outlet and small pipe diameter, no AOP or wildlife passage is provided. Therefore, replacement structures are recommended since any rehabilitation option would further restrict the channel and not provide AOP or wildlife passage.

The new structures are recommended to be two at-grade long span precast concrete arches with an anticipated design life of 100-years. By replacing the entire structure with new buried structures, the foundations will be placed up as high as possible on the side slopes so that the arch span will extend beyond the stream corridor. This is in order to provide better access for wildlife passage and reduced scour risk. Geotechnical borings should be requested early in the design phase to determine the in-situ soil conditions.

The current roadway width on both barrels of I-89 meets the minimum standards roadway width of 38 feet. As such, the typical section of 4'-12'-12'-10' will be maintained for both bridges. The current roadway width on US2 does not meet the minimum standard roadway width of 32 feet. The proposed bridge and approach typical sections should be constructed to 5'-11'-11'-5'.

### Wildlife Connectivity:

The project area is located along the spine of the Green Mountains. I-89 and US2 are significant barriers to terrestrial and aquatic wildlife, separating the Northern Green Mountains from the Southern Green Mountains. This stretch of highway has been studied extensively and species diversity is rich on both sides of the interstate. The Sharkeyville brook culvert was found to be one of the highest priority connection points for wildlife attempting to cross the roads.

Because of the environmental importance of this area one of the main goals of this project is to provide wildlife passage through the new structure. In doing so we will not only be providing safe passage for wildlife and reconnecting two of the largest habitat blocks in the state, but we will also be improving the vehicular safety of the roadway with less vehicle crashes being caused by wildlife crossing the road. The importance of this ecological connection point cannot be understated; it is critical now more than ever to provide wildlife connectivity to this area as wildlife traffic rates across these habitat blocks will only increase as climate change becomes more of a threat to species, forcing them to travel north along the spine of the green mountains.

### Traffic Maintenance:

Traffic is recommended to be maintained on median crossovers during construction.

## **X. Appendices**

Appendix A: Site Pictures

Appendix B: Town Map

Appendix C: Small Culvert Inspection Report

Appendix D: Preliminary Hydraulics Report

Appendix E: Preliminary Geotechnical Information

Appendix F: Resource ID Completion Memo

Appendix G: Natural Resources Memo

Appendix H: Archeology Memo

Appendix I: Historic Memo

Appendix J: Environmental Specialist Resource ID

Appendix K: Hazardous Sites Map

Appendix L: Stormwater Resource ID

Appendix M: Landscape Clearance Resource ID

Appendix N: Bolton Waterbury STP 2709(1) Wildlife Connectivity Study

Appendix O: Local Input

Appendix P: Operations Input

Appendix Q: Crash Data

Appendix R: Detour Maps

Appendix S: Plans



## Appendix A: Site Pictures



Inlet of PID68002



Looking South at Inlet of PID68002



Looking Upstream from inlet



Close up of inlet at PID68002



Looking through the culvert from inlet side.



Outlet of PID68002 (looking north)



Looking southwest over the outlet at scour hole.



Profile of outlet perch PID68002



Scour pool view from north of outlet



Perch view and downstream view from outlet



Looking downstream from outlet PID68002



Looking farther downstream from outlet PID68002





Looking up through culvert to the inlet from the outlet side.



Concrete “wingwall” on east bank upstream of inlet.



Concrete “wingwall” on east bank upstream of inlet (view from west bank upstream of inlet).



Inlet of PID68002, close up of woody debris.

## Appendix B: Town Map

Scale: 1:62,550

N

- ★ INTERSTATE
- STATE LONG
- STATE SHORT
- ▲ TOWN LONG
- ▼ FEDERAL AID
- ◆ BIKE PATH
- INTERSTATE
- STATE HIGHWAY
- CLASS 1
- CLASS 2
- CLASS 3
- CLASS 4
- - - LEGAL TRAIL
- - - PRIVATE
- - - DISCONTINUED
- FEDERAL AID
- MAINTENANCE DISTRICT
- NEIGHBORING DISTRICT (WITH BUFFERED EXTENSION)
- 8 - St. Albans
- POLITICAL BOUNDARY
- VTRANS REGION BOUNDARY
- NAMED RIVER-STREAM
- UNNAMED RIVER-STREAM
- Point from Local Bridge Data \*
- Point from Local Culvert Data \*

\* Points are from local town bridge and culvert inventories. Some points may overlap where VTrans has also conducted an inventory on the Town highway.  
Data source: VOBCT aka VTCulverts

Produced by:  
Mapping Section  
Division of Policy, Planning and  
Intermodal Development  
Vermont Agency of Transportation  
March 2021

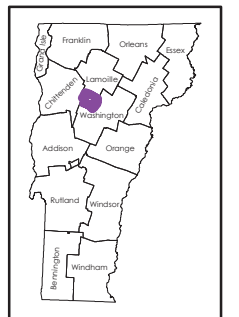

**WATERBURY**  
COUNTY-TOWN CODE: 1218-0  
WASHINGTON COUNTY  
DISTRICT # 5  
District Long Name: Colchester District  
VTrans Four Region: Northwest

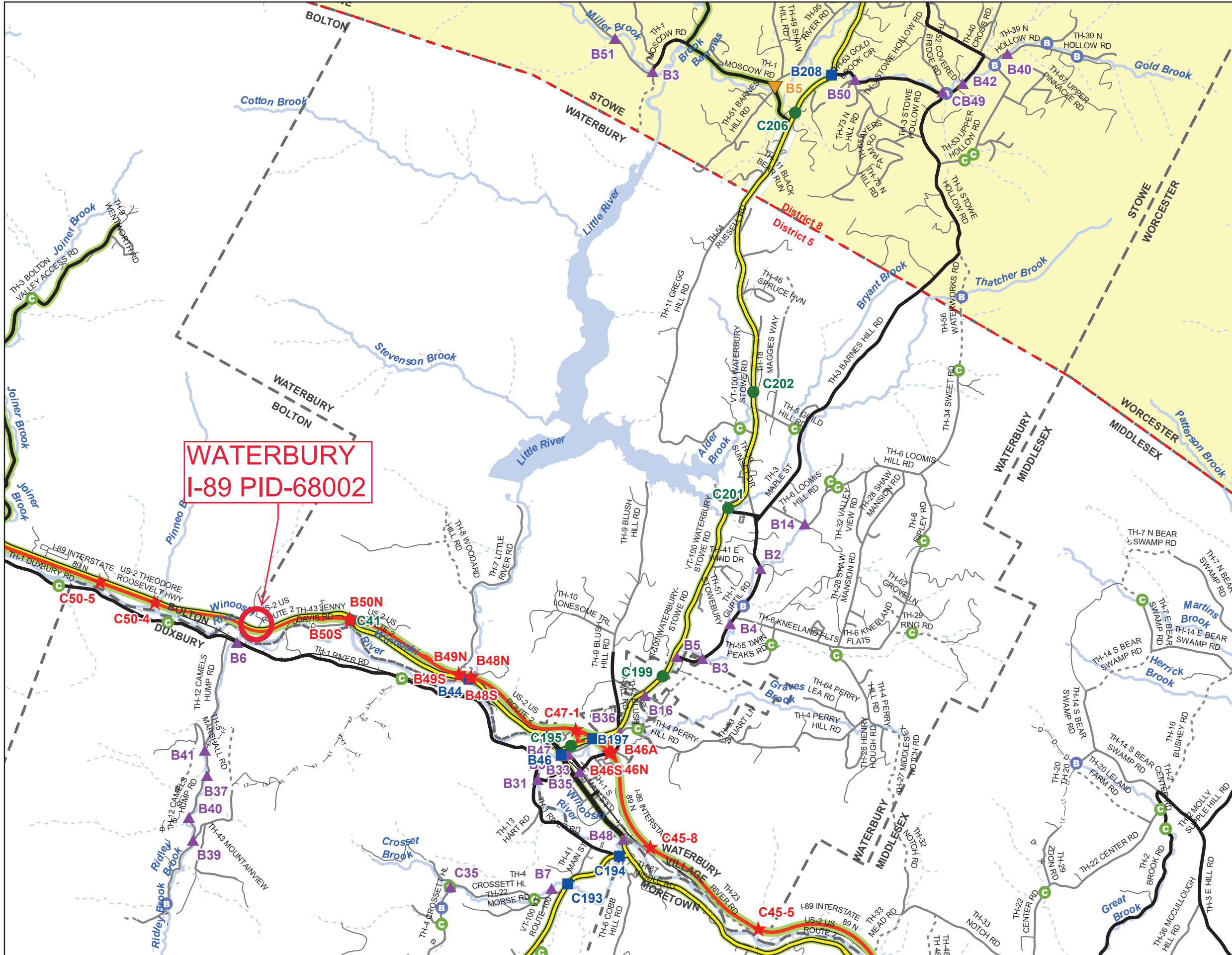

This map was funded in part through grants from the Federal Highway Administration, U.S. Department of Transportation. The representation of the authors expressed herein do not necessarily state or reflect those of the U. S. Department of Transportation.

## **Appendix C: Small Culvert Inspection Report**

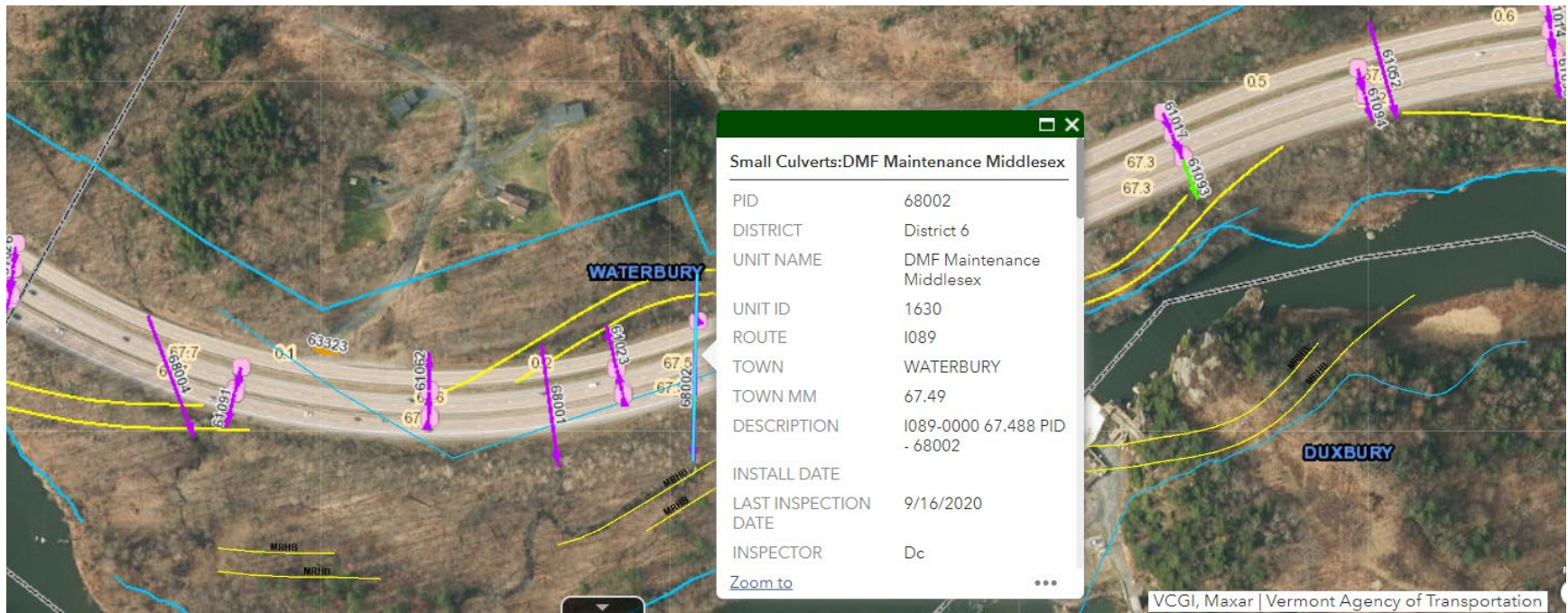

PID	DISTRICT	UNIT NAME	UNIT_ID	TOWN	ROUTE	TOWN MM	DESCRIPTION	INSTALL DATE	LAST INSPECTION DATE	INSPECTOR	MS4	DRAIN TYPE	SYSTEM TYPE	STRUCTURE TYPE
68002	District 6	DMF Maintenance Middlesex	1630	WATERBURY	1089	67.49	1089-0000 67.488 PID - 68002		9/16/2020	Dc	No	Cross	Single Pipe	Round

MATERIAL	MODIFICATIONS	SIZE	OTHER HEIGHT	OTHER WIDTH	FILL DEPTH	ELBOWS	INLET TREATMENT	INLET TIE-IN	INLET EXTENSION	INLET MARKER POST	INLET SEPARATION	INLET CONDITION	INLET SEDIMENT	INLET EROSION
Metal	None	60	60	60	30	NO	Unknown	UNKNOWN	UNKNOWN	NO	UNKNOWN	UNKNOWN	UNKNOWN	UNKNOWN

Small Culverts														
Drop Inlets   Access Holes														
Options Filter by map extent Zoom to Clear selection Refresh														
INLET PIPING	INLET COMMENT	BARREL SEPARATION	BARREL CONDITION	BARREL SEDIMENT	BARREL COMMENT	OUTLET TREATMENT	OUTLET TIE-IN	OUTLET EXTENSION	OUTLET MARKER POST	OUTLET SEPARATION	OUTLET CONDITION	OUTLET SEDIMENT	OUTLET EROSION	OUTLET PIPING
UNKNOWN		UNKNOWN	GOOD	UNKNOWN		Mitered	NO	UNKNOWN	NO	UNKNOWN	GOOD	NONE	NONE	NO

Small Culverts														
Drop Inlets   Access Holes														
Options Filter by map extent Zoom to Clear selection Refresh														
OUTLET COMMENT	PROJECTED END	STONE PAD	ROAD SETTLING	SINK HOLES	GENERAL COMMENT	STRUCTURAL RATING	FUNCTIONAL RATING	FUNCTIONAL STATUS	IN_XLOCATION	IN_YLOCATION	IN_LAT	IN_LONG	OUT_XLOCATION	OUT_YLOCATION
	YES	YES	NONE	NONE					474498.15	206699.49	44.360081	-72.819906	474495.38	206582.05

IN_OUT_LAT	IN_OUT_LONG	ROUTE	TWN_LR	ETE_MM	IN_ZLOCATION	IN_ZFEET	OUT_ZLOCATION	OUT_ZFEET	HIVE	
44.35902	-72.81994		1089-0000	67.49	398.50	-1.00	380.16	-1.00	NO	

## **Appendix D: Preliminary Hydraulics Memo**



**TO:** Laura Stone, Structures, Scoping Engineer

**CC:** Nick Wark, Hydraulics Engineer

**FROM:** Christian Boisvert, Hydraulics Project Engineer

**DATE:** December 28, 2022

**SUBJECT:** Waterbury IM CULV(109) pin #22a107  
Waterbury US-2 and I-89, Br14, over unnamed tributary to Winooski River  
Coordinates: [44.360081, -72.819906](#)

We have completed our hydraulic study for the above referenced site, and offer the following for your use:

In an email on 11/17/22, ANR indicated that a minimum span of 18-ft is recommended for this project site. The design storm flow is 1% AEP (Q100).

### **Existing Conditions:**

**Structure:** The existing structure is a 5-foot diameter corrugated metal plate pipe.

**Model Results:** This structure results in approximate HW/D ratio of 6.3 at the design event with water overtopping the roadway before the check event (0.5% AEP). The HY-8 modeling software utilized for existing conditions does not account for upstream storage. There appears to be enough storage for flood flow attenuation upstream, therefore the roadway may not experience overtopping during the check event.

**Hydraulic Standards:** The existing culvert does not meet the current hydraulic standards, nor does it meet the state stream equilibrium standards for bankfull width.

### **Proposed Option 1:**

**Structure:** An 18-foot span by 9-foot minimum rise four-sided concrete box. The invert is to be buried 3-feet, providing a 6-foot clear height as shown to the right.

**Model Results:** This structure results in HW/D ratios of 0.55 and 0.60 at the design and check AEP, respectively.

**Hydraulic Standards:** This option meets both the current hydraulics standards and state stream equilibrium standards for bankfull width. Option 1 does not increase the 100-year base flood elevations.

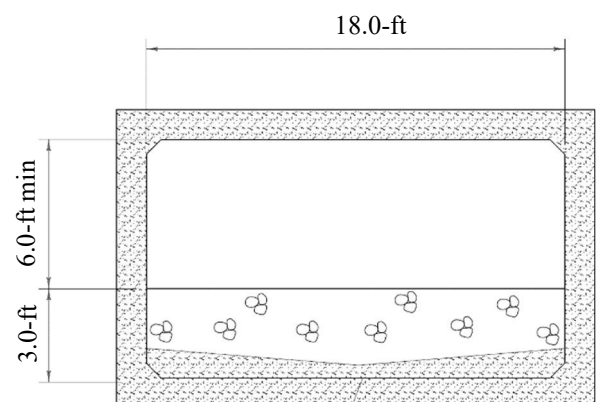

Option 1. Typical Section

**Proposed Option 2:**

**Structure:** An 18-foot span by 6-foot minimum clear height bridge as shown to the right.

**Model Results:** This structure results in freeboard of 2.7 and 2.4 -feet at the design and check AEP, respectively.

**Hydraulic Standards:** This option meets both the current hydraulics standards and state stream equilibrium standards for bankfull width. Option 2 does not increase the 100-year base flood elevations.

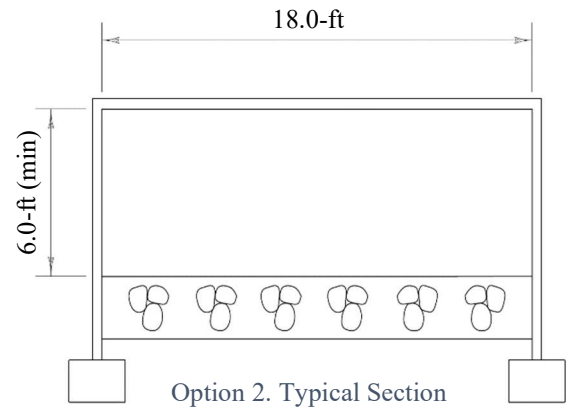

**Additional Comments:**

For options 1 and 2, E-Stone, Type III will need to be used to grade the channel through the respective structures. The channel has significant aggradation upstream of the structure and channel/bank erosion downstream of the structure, see figure 1. We recommend an approximate proposed structure slope of 4.4 to 5.5% and regrading the upstream channel with E-stone, Type III to allow for a better profile alignment, see figure 2. If this grading recommendation cannot be met, please coordinate with the hydraulics unit on other proposed structure slopes. Stone Fill, Type III shall be used to protect any disturbed channel banks or roadway slopes at the structure’s inlet and outlet.

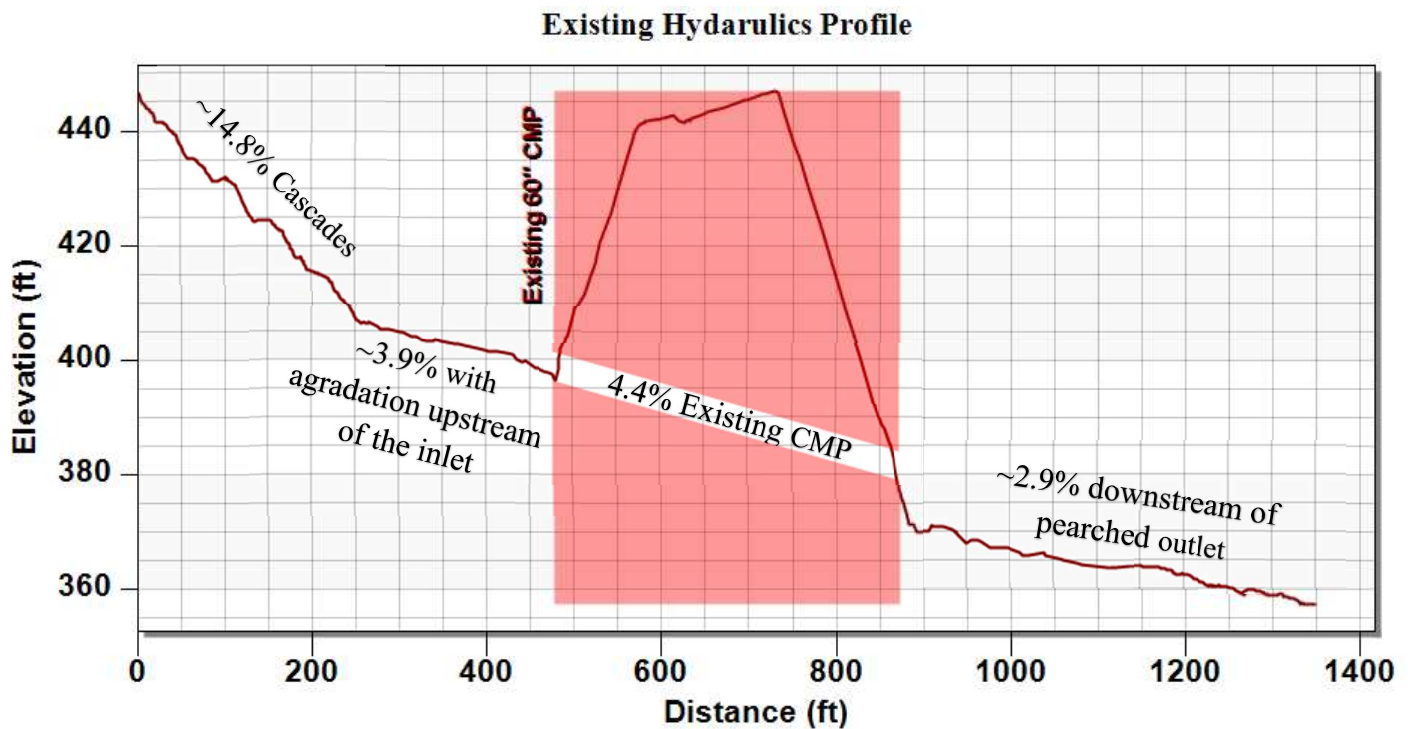

*Figure 1: Existing profile generated from survey and lidar elevation data.*

## Proposed Hydraulics Profile

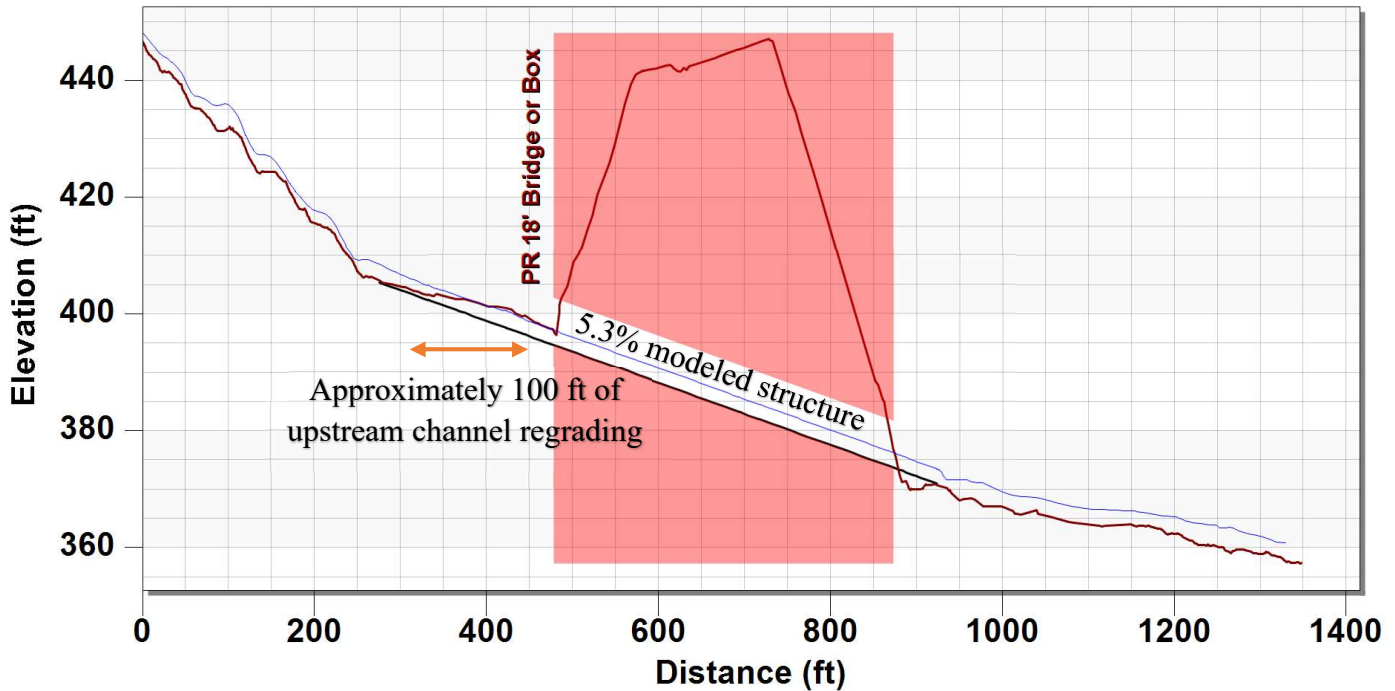

Figure 2: Modeled proposed structure/ channel regrading slope (black) and Q100 water surface elevation (blue)

For option 1, bed retention sills should be added in the bottom of the structure. Sills should be 12 inches high across the full width of the structure. Sills should be spaced no more than 8 feet apart throughout the structure with one sill placed at both the inlet and the outlet.

For option 2, the bottom of abutment footings should be at least 6 feet below the channel bottom, or to ledge.

Other similar sized structures could be considered for this site. If another alternative is considered, coordinate with the Hydraulics Unit to perform additional analyses.

Please contact us with any questions, or to check substructure configuration scenarios.

### Preliminary Hydraulics Summary Table:

Condition	Headwater Depths (ft)		HW/D		Freeboard (ft)		Meets Environmental & Hydraulic Requirements/Standards?				Stone Fill Type
	Q100	Q200	Q100	Q200	Q100	Q200	BFW/Sediment Equilibrium	AOP	Hydraulic	Increases 100-yr WSE?	
Existing	31.4	45.9	6.3	9.2	-	-	No	No	No	-	-
Proposed 1	3.3	3.6	0.55	0.60	-	-	Yes	Yes	Yes	No	III
Proposed 2	3.3	3.6	-	-	2.7	2.4	Yes	Yes	Yes	No	III

## **Appendix E: Preliminary Geotechnical Memo**

**To:** Laura Stone, PE, Scoping Engineer

*END*

**From:** Eric Denardo, PE, Geotechnical Engineer

**Date:** July 27, 2022

**Subject:** Waterbury IM CULV(109) - Preliminary Geotechnical Information

---

## 1.0 INTRODUCTION

As requested, we have completed our preliminary geotechnical investigation of Culvert PID - 68002 which runs under US RT 2 and Interstate 89 in the Town of Waterbury, VT. The 60-inch corrugated galvanized metal plate pipe culvert is located at approximately MM 67.5 of I-89. The project consists of rehabilitation or replacement of the current culvert which is approximately 385 feet (ft) long and buried under up to 60 ft of fill, to meet hydraulic needs and to create a wildlife passage. This review included the examination of as-built record plans, water well logs and hazardous site information on file at the Vermont Agency of Natural Resources (ANR), as well as published surficial and bedrock geologic maps, and information we gained from in-house bridge inspection reports and photos. This project is currently in the scoping phase.

## 2.0 SUBSURFACE INFORMATION

### 2.1 Published Geologic Data

Mapping conducted in 1970 for the Surficial Geologic Map of Vermont, shows that the project site consists of a glacial till (Doll, 1970).

According to the 2011 Bedrock Map of Vermont, published by the State of Vermont and USGS, the site is underlain with Quartzite and Schist of the Hazens Notch Formation (Ratliffe, et. al, 2011).

The Geotechnical Engineering section maintains a GIS database of historical boring logs throughout the state, which contains electronic records of the majority of investigations completed in the past 15 years. During the research into this project, the database did not reveal any nearby borings or projects that could be referenced for information of value.

### 2.2 Water Well Logs

The Vermont ANR documents and publishes a database of all public and private wells that have been drilled in the state. Published online, these logs may provide general characteristics of the soil strata and depth to bedrock in the area. Three private wells were noted within approximately 650 ft of the culvert. The private well located approximately 420 feet northwest of the culvert, (TAG#: 51320) noted 36 ft of topsoil and clay underlain by bedrock. The well located approximately 580 ft to the northwest of the culvert, (TAG#: 57434) noted 8 ft of clay underlain by bedrock. The well located approximately 640 ft to the northwest of the project, (TAG#: 33219) noted 18 ft of clay underlain by bedrock.

### 2.3 Hazardous Materials and Underground Storage Tanks

The ANR Natural Resource Atlas also maintains records of any hazardous material sites and underground storage tanks. Their records show the location of the project is not on the Hazardous Site List. There were no hazardous sites or underground storage tanks within a 0.5 mile radius of the project.

### 2.4 Record Plans

Historic record plans were found from the 1960's of the existing culvert construction as part of the relocation of US 2. The plans did not include any boring information from the culvert but the profile showed an average fill cover of about 30 ft with a maximum fill of approximately 60 ft.

## 3.0 FIELD OBSERVATIONS

A site investigation was not conducted by Geotechnical Section staff however photos from inspections, a site visit conducted by the Structures Section, and satellite imagery were reviewed to evaluate the feasibility of boring operations and assess general site conditions as they relate to the proposed project. Overhead utilities run along the north side of US 2 in the location of the culvert. The subsurface investigation can be adjusted to avoid the overhead utilities and still evaluate the subsurface conditions in this location. The embankments are steep and heavily vegetated which can be seen in Figure 1. If borings are requested in the area of the inlet and outlet, access will need to be constructed and the trees will need to be cleared.



**Figure 1:** *Outlet of the Pipe Showing Steep Wooded Embankment*

#### 4.0 RECOMMENDATIONS

Based on preliminary findings of nearby private wells, bedrock may be within 20 feet of the native material below the fill. The native material, based on geologic mapping, is likely glacial till and consistent across the project. This material is typically suitable for supporting shallow foundations needed to support the wingwalls for a new structure. If replacement is the chosen alternative the culvert could be replaced with a precast reinforced box culvert or metal plate arch with new headwalls and wingwalls. Based on preliminary findings from well logs and published geologic data, the soil conditions at the site should be assessed in more detail for either an open cut or trenchless approach to the culvert replacement operations. The reported glacial till soils can often contain cobbles and boulders which can be prohibitive to both trenchless technologies and support of excavation installation for open cut methods.

##### 4.1 Proposed Subsurface Investigation

The proposed investigation would likely include, at a minimum, borings at opposite corners of the culvert but should also include borings along the alignment of the proposed structure. Borings can be advanced in the roadway of US 2 and the interstate as well as in the median with proper traffic control. If problematic soils are encountered, additional borings should be considered at the locations of the inlet and outlet wingwalls. As previously mentioned, access to the inlet and outlet of the pipe may be difficult but could be accessed with the construction of access roads and drilling platforms. Sampling frequency of the borings should be increased at the proposed bearing elevation to determine if any obstructions or problematic soils exist. This information will be useful if tunneling or jacking techniques are utilized. Additional borings may also be needed if traffic crossovers will be required for construction.

#### 5.0 CLOSING

The Geotechnical Section can assist in developing a subsurface investigation plan that appropriately aligns with information needed for either design or development of RFP documents, considers the risk involved in the project, and the contracting mechanism chosen to move forward with.

If you have any questions or would like to discuss this report, please contact me at [Eric.Denardo@vermont.gov](mailto:Eric.Denardo@vermont.gov).

#### 6.0 REFERENCES

Doll, C. G., 1970, Surficial Geologic Map of Vermont, Vermont Geological Survey, Montpelier, VT.

Ratliffe, N. M., Stanley, R. S., Gale, M. H., Thompson, P. J., Walsh, G. J., 2011, Bedrock Geologic Map of Vermont, Vermont Geological Survey, Montpelier, VT.

Vermont Agency of Natural Resources Department of Environmental Conservation, Natural Resources Atlas, [www.anr.vermont.gov/maps/nr-atlas%20](http://www.anr.vermont.gov/maps/nr-atlas%20), accessed 7/20/2022.

Review by: Stephen Madden, Acting Geotechnical Engineering Manager [SPM](#)

cc: Electronic Read File/MG  
Project File/END

Z:\Highways\CMB\GeotechEngineering\Projects\Waterbury IM CULV(109)\REPORTS\Waterbury IM CULV(109) preliminary geotechnical recommendations.docx



## **Appendix F: Resource ID Completion Memo**



**OFFICE MEMORANDUM**  
AOT - PDB - ENVIRONMENTAL SECTION

**RESOURCE IDENTIFICATION COMPLETION MEMO**

**TO:** Daniel Beard, Project Manager  
**FROM:** Julie Ann Held, Environmental Specialist  
**DATE:** September 28, 2022  
**Project:** Waterbury IM CULV(109)

**ENVIRONMENTAL RESOURCES:**

Archaeological Resources:	<input checked="" type="checkbox"/> Yes	<input type="checkbox"/> No	<u>See Archaeological Resource ID Memo</u>
Historic Resources:	<input type="checkbox"/> Yes	<input checked="" type="checkbox"/> No	<u>See Historic Resource ID Memo</u>
Wetlands:	<input type="checkbox"/> Yes	<input checked="" type="checkbox"/> No	<u>See Natural Resource ID Memo</u>
Aquatic Organism Passage:	<input checked="" type="checkbox"/> Yes	<input type="checkbox"/> No	<u>See Natural Resource ID Memo</u>
Agricultural Soils:	<input type="checkbox"/> Yes	<input checked="" type="checkbox"/> No	<u>See Natural Resource ID Memo</u>
Wildlife Habitat:	<input checked="" type="checkbox"/> Yes	<input type="checkbox"/> No	<u>See Natural Resource ID Memo</u>
Endangered Species:	<input checked="" type="checkbox"/> Yes	<input type="checkbox"/> No	<u>See Natural Resource ID Memo</u>
Stormwater Considerations:	<input checked="" type="checkbox"/> Yes	<input type="checkbox"/> No	<u>See Stormwater Resource ID Memo</u>
Landscape Considerations:	<input checked="" type="checkbox"/> Yes	<input type="checkbox"/> No	<u>See Landscape Resource ID Memo</u>
6(f) Properties:	<input type="checkbox"/> Yes	<input checked="" type="checkbox"/> No	<u>See Environmental Specialist Resource ID Memo</u>
Hazardous Waste:	<input type="checkbox"/> Yes	<input checked="" type="checkbox"/> No	<u>See Environmental Specialist Resource ID Memo</u>
Contaminated Soils:	<input type="checkbox"/> Yes	<input checked="" type="checkbox"/> No	<u>See Environmental Specialist Resource ID Memo</u>
Wild Scenic Rivers:	<input type="checkbox"/> Yes	<input checked="" type="checkbox"/> No	<u>See Environmental Specialist Resource ID Memo</u>
Act 250 Permits:	<input checked="" type="checkbox"/> Yes	<input type="checkbox"/> No	<u>See Environmental Specialist Resource ID Memo</u>
FEMA Floodplains:	<input type="checkbox"/> Yes	<input checked="" type="checkbox"/> No	<u>See Environmental Specialist Resource ID Memo</u>
Flood Hazard Area:	<input type="checkbox"/> Yes	<input checked="" type="checkbox"/> No	<u>See Environmental Specialist Resource ID Memo</u>
River Corridor:	<input checked="" type="checkbox"/> Yes	<input type="checkbox"/> No	<u>See Environmental Specialist Resource ID Memo</u>
Protected Lands:	<input type="checkbox"/> Yes	<input checked="" type="checkbox"/> No	<u>See Environmental Specialist Resource ID Memo</u>
US Coast Guard:	<input type="checkbox"/> Yes	<input checked="" type="checkbox"/> No	<u>See Environmental Specialist Resource ID Memo</u>
Lakes and Ponds:	<input type="checkbox"/> Yes	<input checked="" type="checkbox"/> No	<u>See Environmental Specialist Resource ID Memo</u>
Scenic Highway/ Byway:	<input type="checkbox"/> Yes	<input checked="" type="checkbox"/> No	<u>See Environmental Specialist Resource ID Memo</u>
Environmental Justice:	<input type="checkbox"/> Yes	<input checked="" type="checkbox"/> No	<u>See Environmental Specialist Resource ID Memo</u>
Other:	<input type="checkbox"/> Yes	<input checked="" type="checkbox"/> No	<u>See Environmental Specialist Resource ID Memo</u>

cc:  
Project File

## **Appendix G: Natural Resources Memo**

To: Julie Ann Held, VTrans Environmental Specialist  
From: Glenn Gingras, VTrans Environmental Biologist  
Date: 8/30/2022  
Subject: Waterbury IM CULV (109) - Natural Resource ID

### Introduction

The Waterbury IM CULV (109) project is in for resource identification. The project area involves a PID 68002 metal culvert, known as the “Sharkyville culvert” is a state-owned culvert located off US Route 2 and extends under US2 and both barrels of I-89 at mile marker 67.49. The culvert crossing is approximately 0.18 miles eastbound along US2 from the intersection of US2 and Sharkyville Road. (Figure 1). I have included areas immediately upstream and downstream of the existing culvert and approach work. I reviewed existing remote sensing mapping to include: ANR Natural Resource Mapping, NRCS soil mapping and VT Fish and Wildlife Natural Heritage Inventory. A field visit was also performed on 7/18/2022.

### Wetlands/Watercourses:

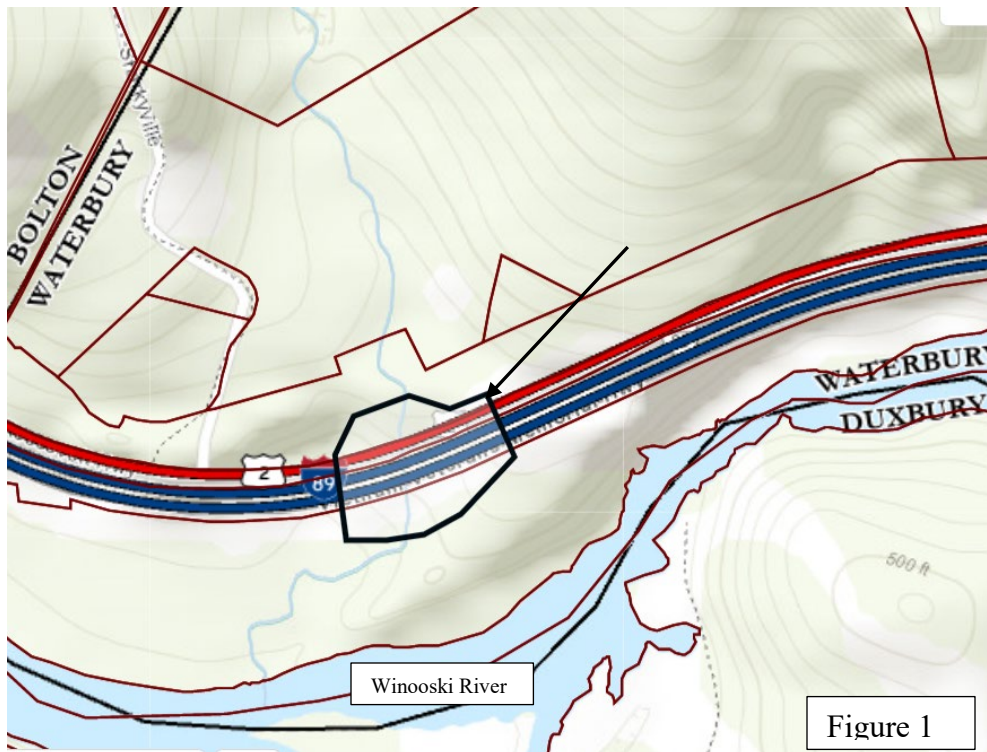

Wetlands were delineated in accordance with the US Corps of Engineers Wetland Delineation Methodologies. No wetlands were identified within the immediate vicinity of the culvert. There were wetlands outside the study area on the south side of I89 to the east of the outlet of the culvert.

An unnamed tributary of the Winooski River flows southerly beneath US Route 2 and both I-89 NB and SB lanes.

The unnamed tributary is regulated by the US Army Corps of Engineers and the Agency of Natural Resources. Project design alternatives need to avoid

and minimize impacts to regulated waterways to the maximum extent practicable.

### Wildlife Habitat:

The project area is located along the spine of the Green Mountains. Interstate 89 (and traffic barrier) and US 2 (traffic and infrastructure) present a significant barrier to terrestrial and aquatic wildlife, separating the Northern Green Mountains from the Southern Green Mountains. This stretch of highway has been studied extensively and

species diversity is rich on both sides of the interstate. Protected lands are within this corridor of the interstate as well. The area is mapped within the VT Fish and Wildlife Bio Finder mapping as Highest Priority- Surface Water and Riparian Areas, Physical Landscape Diversity and Riparian and Wildlife Connectivity (Figure 2). Reestablishing connectivity to aquatic and terrestrial species should be considered on all replacement options.

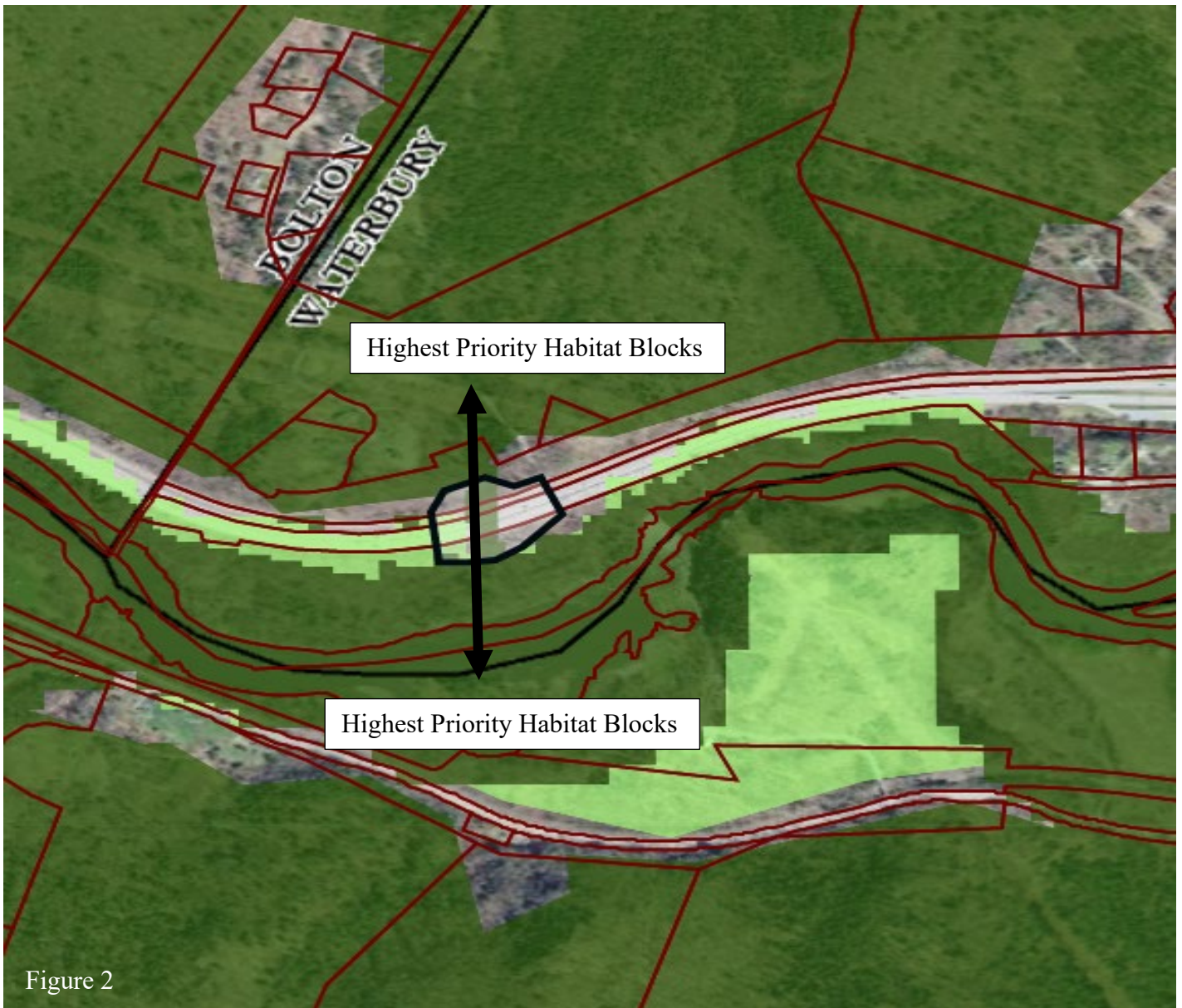

**Rare, Threatened and Endangered Species:**

I have queried the VT Fish and Wildlife Natural Heritage database. An historical occurrence of Fragrant fern (*Dyopteris fragrans*) a state listed rare (S2) plant is known to occur around the Bolton Falls. This species does not have regulatory protection unless we trigger Act 250. There is a state listed (T) freshwater mussel within the Winooski River outside the project area.

I have queried the USFWS' Information, Planning and Conservation Planning website and two species were identified as potentially present in the action area: northern long-eared bat (*Myotis septentrionalis*), and the Monarch Butterfly (*Danaus plexippus*).

The project site is located within the summer range of the federally threatened (proposed endangered) and state endangered northern long-eared bat (Agency of Natural Resources, 2022). Suitable summer habitat for this species includes trees  $\geq 3$  inches in diameter that contain exfoliating or furrowed bark, cracks, crevices and/or cavities (U.S. Fish and Wildlife Service, 2022). The northern long-eared bat has also been documented roosting in structures with suitable microclimates (Vermont Fish and Wildlife Department, 2016).

There are no known hibernacula or known maternity roosts within 1- mile of the project site for northern long eared bats. There is potentially suitable habitat adjacent to the Project site including potential roost trees. Depending on the scale of the project, we may want to conduct these surveys to know if this species is present or not.

The Project also occurs within the summer range of the monarch butterfly, a species undergoing review for potential listing under the Endangered Species Act (USFWS, 2022). No critical habitat has been designated for this species.

**Agricultural Soils:**

No mapped prime agricultural soils are present in the project area.

**Conclusion:**

Regulated natural resources present within the study area include an unnamed tributary of the Winooski River significant wildlife habitat corridor, and potential suitable habitat for a federally/state listed bat species.

## Appendix H: Archeology Memo

**Jeannine Russell**  
**VTrans Archaeology Officer**  
**State of Vermont**  
**Environmental Section**

Barre City Place  
219 Main St.  
Barre City, VT 05641  
802-477-3460 phone  
[Jeannine.russell@vermont.gov](mailto:Jeannine.russell@vermont.gov)

*Agency of Transportation*

To: JulieAnn Held, Environmental Specialist  
From: Jeannine Russell, VTrans Archaeology Officer  
Date: August 31, 2022  
Subject: Waterbury IM CULV(109) – Archaeological Resource ID

This project is located on I-89 at MM 67.490 in Waterbury just east of the Waterbury/Bolton town line. The scope for this project has yet to be defined and therefore the VTrans Archaeology Officer reviewed an area surrounding the culvert that is sufficient to allow for access and potential staging for a variety of alternatives.

The project area sits on the edge of a high ridge within the spine of the Green Mountains overlooking the Winooski River. The culvert carries an unnamed stream from the mountains to the Winooski River. Two Pre-Contact sites have been recorded in the vicinity south of the Winooski River on a high terrace south of Bolton Falls. These are VT-WA-0002 which is a multi-component site containing Archaic period artifacts in addition to Iroquoian pottery, and muskets found within a “water cave”. The second site VT-WA-0008 is a rumored site that was recounted by a Green Mountain Power employee who told of a cave shelter containing artifacts.

The general project area is characterized as very steep slopes on both sides of I-89. Along the north (inlet) side, the stream sits in a narrow area between steep slopes. Two concrete slabs are situated adjacent to the river but do not appear to be associated with any archaeological feature and may be part of an old bridge abutment for something like a logging road or even access while constructing the interstate.

At the southern (outlet) end, the stream empties into a large scour pool and then runs along a level lower terrace to a mapped wetland along the river in what is beyond the southwest quadrant. Some of the area to the east appears to have been disturbed and uneven areas appear in the landscape. However, there is a long, narrow area along the edge of the stream that exhibits an organic layer over intact floodplain soils. Further south right along the edge of the river there is one small terrace that sits on a higher ridge that is also considered sensitive, but this area is well outside the areas likely to be impacted by the project.

Sensitive areas are illustrated in the map below and have been entered into a .dgn file for plans design.

Please let me know if you have any questions.

*Jeannine Russell*

Thank you,  
Jen Russell  
VTrans Archaeology Officer





Google aerial image of project location in context (yellow)

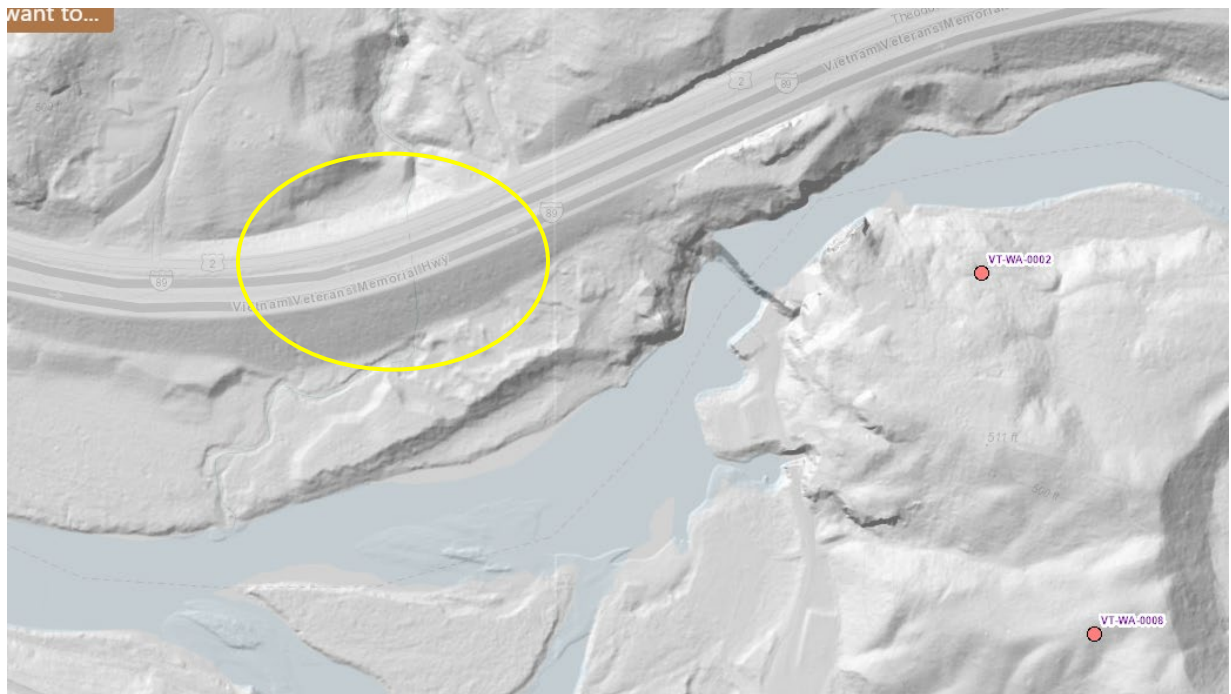

ORC LiDAR map showing project area (yellow) and recorded sites



Image of culvert at north (inlet) end. Note concrete slabs center left and row of stones (rip rap) center right of stream channel



View of outlet end from base of slope looking upward toward I-89



View of outlet end and scour area from slope. Portions of the lower level terrace can be seen beyond the scour area before the land rises to the higher terrace.

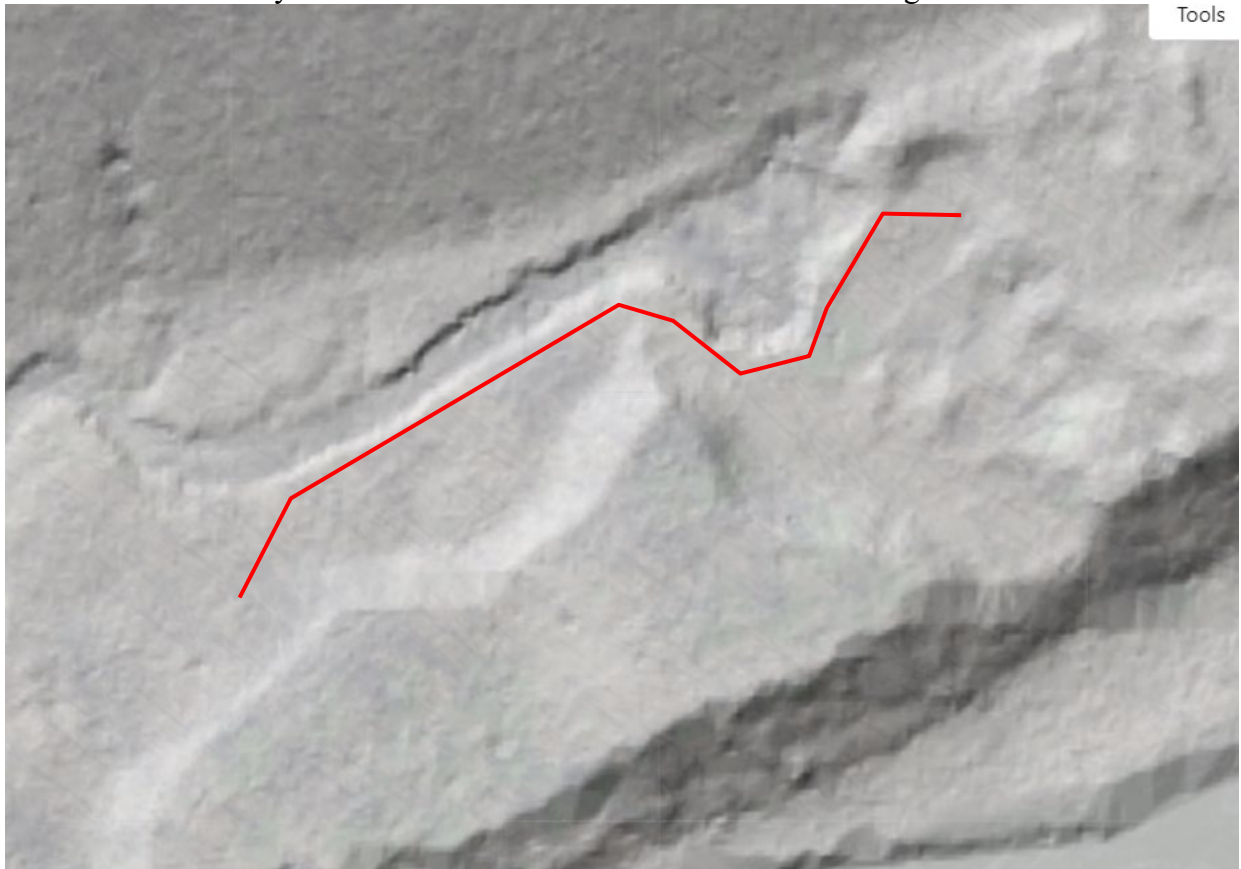

LiDAR image showing area of arch sensitivity (both low and high terraces)

## **Appendix I: Historic Memo**

Vermont Agency of Transportation  
Project Delivery Bureau - Environmental Section  
Barre City Place  
Tel: 802.595-3744

**To:** JulieAnn Held, Environmental Specialist  
**From:** Judith Williams Ehrlich, VTrans Historic Preservation Officer  
**Date:** September 28, 2022  
**Subject:** Historic Resource Identification for Culvert PID 68002 on I-89 in Waterbury

---

I have completed a resource identification (ID) for Culvert PID 68002 on I-89 in Waterbury. At this time, we are evaluating whether this culvert is historic and also identifying if there are historic resources in the area of the culvert.

Culvert PID 68002 is a 60” metal pipe culvert that extends under U.S. 2 and both barrels of I-89 NB and SB in Waterbury.

This Resource Identification effort is being undertaken to provide information to the VTrans designers working on a proposed improvement project. Toward that end, VTrans Cultural Resources staff have identified potential resources within a broad preliminary Area of Potential Effect to ensure the designers are aware of all cultural resources that could possibly be affected by a project. Once the project is defined at the Conceptual Design phase, Cultural Resources staff will be able to determine a formal Area of Potential Effect for purposes of Section 106 and 22 VSA § 14.

The majority of the Interstate Highway System is exempt from consideration as an historic resource under Section 106 of the National Historic Preservation Act and Section 4(f) of the Department of Transportation Act requirements. The project area along I-89 in Waterbury is located within the right of way of the Interstate Highway System and, as such, is not subject to Section 106 review per the Section 106 Exemption Regarding Effects to the Interstate Highway System adopted by the Advisory Council on Historic Preservation on March 7, 2005. (See Federal Register Vol.70/No.46).

However, the culvert also runs under U.S. Route 2, which is subject to Section 106 review so PID 68002 should be evaluated for National Register eligibility. This metal pipe culvert is not considered historic per the Registration Requirements established in the Historic Bridges of Vermont MPDF so is not eligible for listing on the National Register of Historic Places.

The culvert is located within the state ROW. There are no historic properties on any properties adjacent to the ROW near the culvert.

Please do not hesitate to contact me should you require additional information.



Google Earth aerial view of the location of the culvert. Note the area surrounding the culvert is not developed.

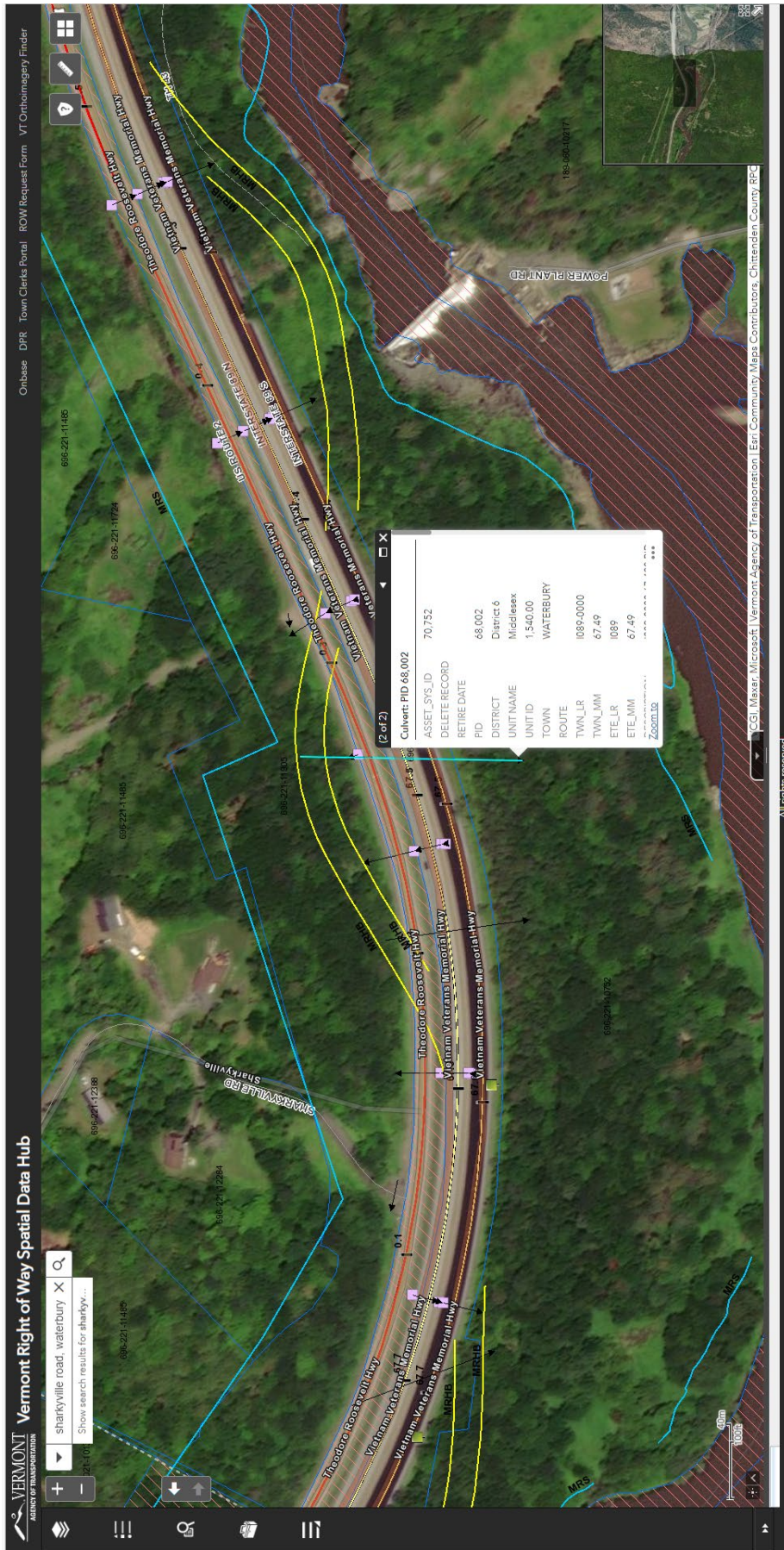

Image of Vermont ROW Spatial Data Hub showing location of Culvert PID 68002.



Culvert inlet





Culvert outlet



Concrete headwall

## **Appendix J: Environmental Specialist Resource ID**

Date: September 28, 2022  
Project: Waterbury IM CULV(109)

**6(f) Properties:**

There aren't any 6(f) Properties within the project area.

**Hazardous Waste:**

There aren't any Hazardous Wastes Sites identified within the project area.

**Contaminated Soils:**

There aren't any Contaminated Soils within the project area.

**Wild Scenic Rivers:**

There aren't any designated Wild Scenic Rivers within the project area.

**Act 250 Permits:**

There are adjacent parcels that have Act 250 Permits and may need to be amended if impacted. The Permit adjacent to the project is permit no. 5W1448 for the creation of an eight lot subdivision on 139 acres next to Sharkville Road. If there is any work outside the ROW and material changes are made, an amendment will be required.

**FEMA Floodplains:**

There aren't any FEMA Floodplains mapped within the project area.

**River Corridor:**

There are River Corridors mapped within the project area and a Flood Hazard Area/ River Corridor Permit may be required if there are impacts.

**Protected Lands:**

There aren't any Protected Lands within the project area.

**US Coast Guard:**

There aren't any US Coast Guard navigable waterways within the project area.

**Lakes and Ponds:**

There aren't any lakes or ponds within the project area.

**Scenic Highway/ Byway:**

There aren't any Scenic Highway/ Byways within the project area.

**Environmental Justice:**

There are no EJ populations present within the study area, therefore there is no potential to have a disproportionately high and adverse effect.

**Other:**

There aren't any other resources within the project area.

---

## **Appendix K: Hazardous Sites Map**

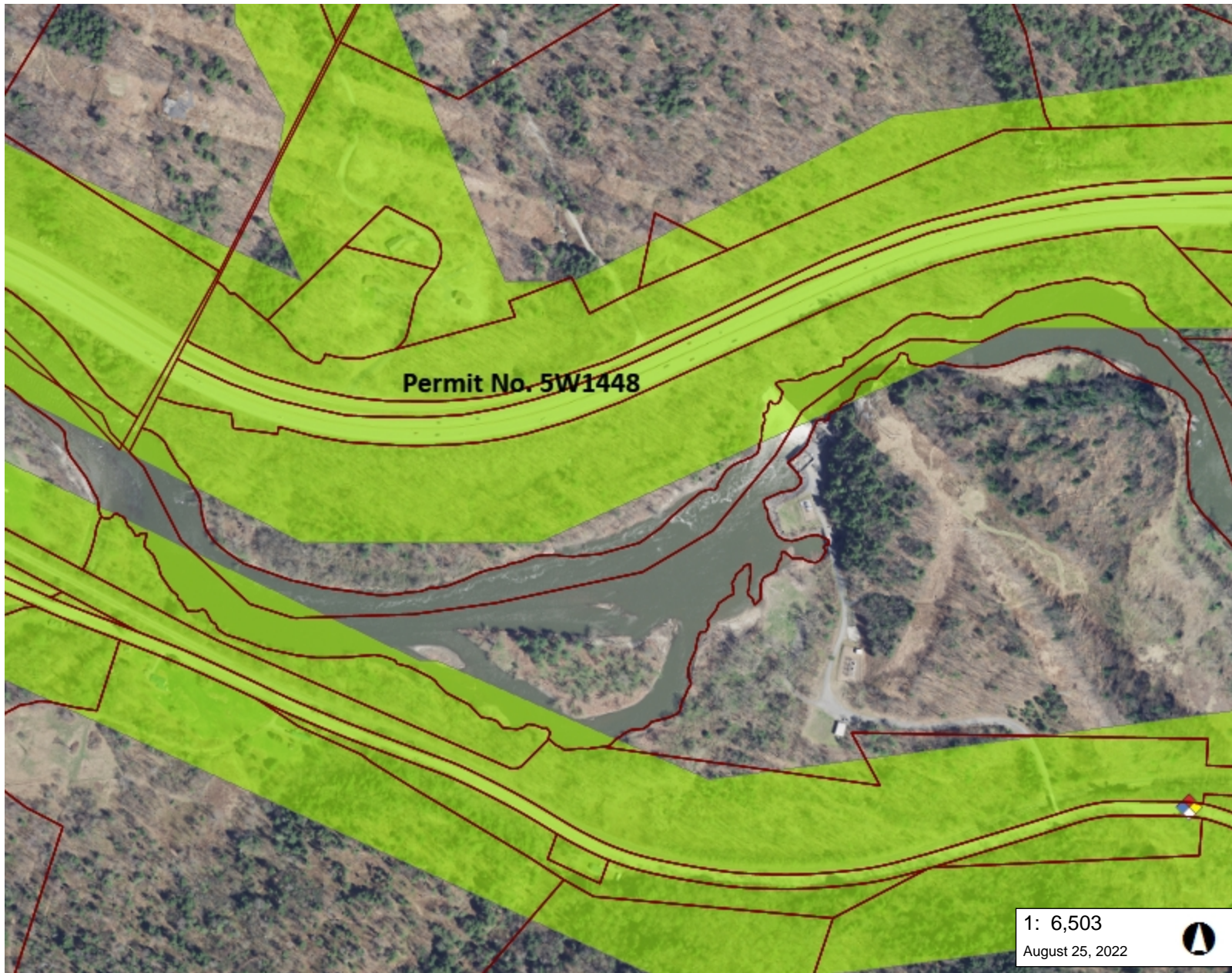

### LEGEND

- Landfills**
  - OPERATING
  - CLOSED
- Land Use Restrictions**
  - Class IV GW Reclass
  - Class VI GW Reclass
  - Deed Restriction
  - Easement
  - Land Record Notice
  - Other
- Hazardous Site
- Hazardous Waste Generators
- Brownfields
- Salvage Yard
- Aboveground Storage Tank
- Underground Storage Tank (w/...)
- Dry Cleaner
- Architectural Waste Recycling
- Urban Soil Background Areas
- Parcels (standardized)

1: 6,503  
August 25, 2022

### NOTES

Map created using ANR's Natural Resources Atlas

330.0 0 165.00 330.0 Meters  
 WGS\_1984\_Web\_Mercator\_Auxiliary\_Sphere 1" = 542 Ft. 1cm = 65 Meters  
 © Vermont Agency of Natural Resources THIS MAP IS NOT TO BE USED FOR NAVIGATION

DISCLAIMER: This map is for general reference only. Data layers that appear on this map may or may not be accurate, current, or otherwise reliable. ANR and the State of Vermont make no representations of any kind, including but not limited to, the warranties of merchantability, or fitness for a particular use, nor are any such warranties to be implied with respect to the data on this map.

## **Appendix L: Stormwater Resource ID**

State of Vermont  
Environmental Section  
219 North Main Street  
Barre, Vermont 05641  
Vtrans.vermont.gov

Agency of Transportation

[phone] 802-595-9143

To: Julie Ann Held, VTrans Environmental Specialist  
From: Jon Armstrong, Stormwater Management Engineer  
Date: August 18, 2022  
Subject: WATERBURY IM CULV(109) Stormwater Resource ID Review

**Project Description:** I have reviewed the project area for stormwater related regulatory and water quality concerns. This project Location is MM 67.49 of I-89, and MM0.25 on US Route 2 in Waterbury. The scope hasn't yet been determined, but Initial projections are for a new bridge to replace the 60" dia round metal culvert which conveys an unnamed tributary to the Winooski river under US2 and I89.

My evaluation has included the review of existing imagery and mapping (ANR Natural Resource Atlas, VTrans Operational Stormwater Permits) to capture existing stormwater features and existing drainage.

#### Regulatory Considerations

Depending on the scope and extent of the impacts to impervious surface, it seems likely that an Operational stormwater permit (OSW) will be required for this project. The trigger for a permit associated with this project would be if there is greater than 0.5ac of redevelopment (full depth reconstruction) of impervious surface. If an OSW permit is not triggered, but the area of disturbance is above 1 acre, that would trigger the need for a construction SW permit and also require the project to follow the TS4 "Gap" procedure and incorporate feasible post construction treatment measures. There are no existing stormwater permits near the site area. No formal stormwater treatment is located within the ROW. It will be useful early in the design to quantify the stormwater related impacts on a Project Impact Data Form to determine if jurisdiction for a permit will be triggered.

The following are not noteworthy stormwater regulatory concerns at this time:

- This project site is not within a designated groundwater public water supply source protection area.
- The project site is not located within a stormwater impaired (303(d) list) watershed.

#### Existing Drainage

The project area largely consists of sheet flow over the fairly steep road embankments with no apparent defined drainage conveyances.

#### Design Considerations

To the extent feasible, sheet flow through vegetation should be encouraged with the design. Soils in the project area are shown as hydrologic soil group C/D on the upstream side of the project area (not well suited for infiltration treatment practices) and B on the downstream side, although much of the project area is likely undefined fill associated with the roadway prism. The project design should ideally conform to the VTrans Phosphorus Control Highway Drainage Management Standards and there is a potential that VTrans can get credit towards our Phosphorus reduction target for the Lake Champlain Phosphorus TMDL as part of our TS4 permit Phosphorus Control Plan.

## **Appendix M: Landscape Clearance Resource ID**





**State of Vermont** | Agency of Transportation  
Environmental Section  
219 North Main  
Barre, VT 05641  
[Vtrans.vermont.gov](http://Vtrans.vermont.gov)

To: Project File  
From: Bonnie Kirn Donahue, *VTrans Landscape Architect*  
Date: June 21, 2022  
Project: **WATERBURY IM CULV(109) 22A107**  
Subject: Landscape (LA) Clearance for Resource ID

### **SUMMARY**

I have reviewed the proposed area for **WATERBURY IM CULV(109) 22A107**, and have determined that there will be major plant impacts occurring as a result of the proposed work:

- Initial projections are for a new bridge to replace the short culvert.

### **DESCRIPTION OF IMPACT**

The inlet and outlet end of the existing culvert are located deep in mature forest. The forest on both ends has evidence of the presence of terrestrial and aquatic wildlife. There are beaten paths made by animals throughout the area. The outlet end is difficult to access, and far below the interstate, therefore extensive tree clearing may be required in and beyond the riparian buffer.

#### Riparian Buffer:

Riparian and wetland buffers serve an important purpose for the health of Vermont's water quality and wildlife. They prevent erosion on steep embankments, provide shade, food sources and woody debris for healthy aquatic habitat, and provide wildlife corridors along wetlands and streams. With a vegetated riparian buffer, sediment and pollutants like phosphorus are prevented from entering water bodies, keeping our rivers, ponds and lakes clear from algae and cool for fish and other aquatic species to thrive. Revegetating areas where riparian and wetland buffers are impacted establishes a connection between the newly completed project with the existing conditions. Selecting native plants that complement the character of the area will make projects more visually appealing and merge the transportation asset with its surroundings.

Using native trees and shrubs in addition to a seed mix speeds up natural succession, establishing an effective riparian buffer more quickly than using seed alone. Selecting plants that have already started to grow will also have a better chance of establishing before invasive plants have a chance to fill in.

## RECOMMENDATIONS

1. I recommend minimizing the extent of tree clearing as much as possible.
2. I recommend incorporating safe aquatic and terrestrial wildlife passage into the design of the bridge.
3. I recommend re-vegetating the area with native trees and shrubs for river buffers, willow fascines or live stakes (depending on soil conditions at the waters' edge) and a diverse pollinator seed mix.
  - a. See the *2022 VTrans Riparian Planting Toolkit* for design guidelines and species ([link](#)).

## NOTES

1. I would be glad to assist with a plant list and plan ([bonnie.donahue@vermont.gov](mailto:bonnie.donahue@vermont.gov)).

## **Appendix N: Bolton Waterbury STP 2709(1) Wildlife Connectivity Study**



**Bolton Waterbury STP 2709(1)**  
**Wildlife Connectivity Study**  
**Final Report**

Prepared by

**McFarland Johnson**

In association with

**James S. Andrews**

**Northern Stewards**

**July 2016**





**Bolton Waterbury STP 2709(1)**

**Wildlife Connectivity Study**

**Final Report**

**July 2016**

**Table of Contents**

EXECUTIVE SUMMARY ..... 5

RATIONALE FOR STUDY..... 8

STUDY QUESTIONS..... 8

METHODS..... 15

TRAIL CAMERA RESULTS ..... 18

    Introduction ..... 18

    Overall Results (combined results of all cameras)..... 19

    Camera Results by Station ..... 20

    Camera Results by Corridor Location ..... 25

WINTER TRACKING RESULTS..... 28

    Introduction ..... 28

    Transect Tracking Results: Distance from Road..... 30

    Road Tracking Results: Overall..... 34

    Road and Transect Tracking Results: Track Density..... 35

        Track Density Along I-89 Segments..... 47

        Track Density Along the River Road Study Corridor ..... 51

    Road Tracking Results: Culvert and Bridge Usage ..... 52

DISCUSSION..... 59

    Comparing Tracking and Camera Results ..... 59

    Study Questions ..... 60

    Importance of I-89 Segments to Connectivity ..... 64

## Appendices

A	Photo Log
B	Camera Dates of Deployment and Calculation of Camera-years
C	Transect Lengths and Calculations

## List of Tables

Table 1. Primary and secondary focus species .....	15
Table 2. Numbers of animals of all species photographed at all cameras .....	19
Table 3. Comparison of road and transect tracking effort .....	29
Table 4. I-89 winter tracking summary .....	34
Table 5. Comparison of transect and road tracking results, per 400 feet per 90 days.....	36
Table 6. Comparison of transect and road permeability, assuming transect line represents 100% permeability.....	37
Table 7. Numbers of tracks of each species found using structures under I-89 during winter.....	53
Table 8. Numbers of tracks of each species found using structures under I-89 during winter, grouped by structure size.....	54

## List of Figures

Figure 1. Vermont Ecological Habitat Blocks .....	9
Figure 2. Study area with roadway study segments highlighted.....	11
Figure 3. Previously mapped habitat features and wildlife crossing values for study area .....	12
Figure 4. Potential impediments to wildlife movement across I-89.....	13
Figure 5. Transect and camera station layout .....	14
Figure 6. Number of deer photographed at each camera station (per camera/year) .....	21
Figure 7. Number of coyotes photographed at each camera station (per camera/year) .....	21
Figure 8. Number of black bears photographed at each camera station (per camera/year).....	22
Figure 9. Number of moose photographed at each camera station (per camera/year).....	22
Figure 10. Number of fishers photographed at each camera station (per camera/year) .....	23
Figure 11. Number of bobcats photographed at each camera station (per camera/year) .....	23
Figure 12. Number of foxes photographed at each camera station (per camera/year) .....	24
Figure 13. Number of raccoons photographed at each camera station (per camera/year) .....	24
Figure 14. Number of animals/camera/year - all species.....	26
Figure 15. Number of animals/ camera/year - all species excl. deer .....	26
Figure 16. Number of animals/ camera/year – primary and secondary species.....	26
Figure 17. Number of animals/ camera/year – primary and secondary species excl. deer .....	26
Figure 18. Number of animals/ camera/year - primary species .....	26

Figure 19. Number of animals/ camera/year - primary species excl. deer .....	26
Figure 20. Number of animals/camera/year - deer .....	27
Figure 21. Number of animals/camera/year - coyote .....	27
Figure 22. Number of animals/camera/year – black bear .....	27
Figure 23. Number of animals/camera/year - moose .....	27
Figure 24. Number of animals/camera/year - fisher .....	27
Figure 25. Number of animals/camera/year - bobcat .....	27
Figure 26. Number of track sets/400 feet/90 days - all species .....	30
Figure 27. Number of track sets/400 feet/90 days – primary and secondary species .....	31
Figure 28. Number of track sets/400 feet/90 days - primary species .....	31
Figure 29. Number of track sets/400 feet/90 days – primary species excl. deer .....	32
Figure 30. Number of track sets/400 feet/90 days - deer .....	32
Figure 31. Number of track sets/400 feet/90 days - coyote.....	33
Figure 32. Number of track sets/400 feet/90 days - fisher.....	33
Figure 33. Track densities along I-89 and River Road segments - all species .....	39
Figure 34. Track densities along I-89 and River Road segments – primary and secondary focus species .	40
Figure 35. Track densities along I-89 and River Road segments – primary focus species .....	41
Figure 36. Track densities along I-89 and River Road segments – deer .....	42
Figure 37. Track densities along I-89 and River Road segments – coyote .....	43
Figure 38. Track densities along I-89 and River Road segments – fox.....	44
Figure 39. Track densities along I-89 and River Road segments – fisher .....	45
Figure 40. Track densities along I-89 and River Road segments – mink.....	46
Figure 41. Culverts and bridges used by wildlife (1) .....	55
Figure 42. Culverts and bridges used by wildlife (2) .....	56
Figure 43. Culverts and bridges used by wildlife (3) .....	57
Figure 44. Culverts and bridges used by wildlife (4) .....	58
Figure 45. Numbers of deer photographed by month of year and corridor location .....	60
Figure 46. Relative wildlife crossing value of road segments .....	67

## List of Photos

Photo 1. I-89 bridge over US 2 and Joiner Brook in Bolton Village.....	47
Photo 2. End of chain link fence and beginning of median Jersey barrier .....	48
Photo 3. Condition of chain link fence.....	48
Photo 4. Segment with Jersey barrier in median and rock cuts on both sides of I-89 .....	49
Photo 5. Chain link fence meeting rock cut section.....	49
Photo 6. Rest area with parallel chain link fences and smaller rock cut .....	50
Photo 7. I-89 forested both sides to pavement edge with no obvious barriers.....	51
Photo 8. Typical segment of River Road (Duxbury Road) in study area .....	51



INTENTIONALLY BLANK

## **EXECUTIVE SUMMARY**

### **Purpose of Study**

This study was undertaken to answer the following questions:

- Is the habitat in the vicinity rich in wildlife?
- Is there an edge effect zone along the corridor?
- Is the I-89/Route 2 corridor currently a fragmenting feature?
- Is wildlife road mortality currently occurring?
- Are existing culverts and bridges facilitating wildlife movement?
- Would infrastructure modifications improve wildlife movements across barriers?

### **Methods**

The study focused on medium- to large-sized, wide-ranging mammals. The principal means of collecting information on these species and answering the study questions included the placement of 40 wildlife cameras and winter tracking for two consecutive years. Wildlife cameras were placed at the larger existing culverts, the Little River bridge, along transects perpendicular to the roads, and in some locations more distant from the main roads. Winter tracking was undertaken at least twice each winter along transects, I-89, and a local road.

### **Responses to Study Questions**

Results showed that a broad range of medium- and large-sized mammals occur on both sides of the corridor, near and far from the roads. The distribution of most species changes with distance from the road edge, so it is concluded there is an edge effect. Most focus species appear to be repelled by the road corridor, but others, such as deer and fox, may be attracted to the forest edge habitat or the open-canopy habitat between the road and forest.

Many more animals crossed the woodland transects than crossed River Road or I-89, and more crossed River Road than I-89. This suggests that these roads inhibit or deter animal movements, and that larger roads such as I-89 have a greater inhibitory effect than smaller roads. The road corridor therefore can be said to fragment habitats and wildlife populations in the general area. The degree of fragmentation appears to vary with the species and other factors such as the presence of natural and man-made barriers.

Some apparent road mortality was observed (8 dead animals along I-89 over two winters), and appear to confirm historical records of wildlife mortality on this segment of I-89.

Winter tracking showed that about one-fifth of animals entering the I-89 roadway passed through culverts and 10 percent passed under bridges. The most frequently used structures

included the Pineo Brook box culvert, a 36-inch CMP near Sharkeyville Road, a 42-inch RCP west of Little River, and the Little River bridge. Several other structures carried a few sets of tracks, including two bridges, two 36-inch CMPs, a 48-inch CMP, and a 48-inch RCP. Some structures under I-89 did not show animal usage during this study's tracking rounds.

Tracking showed relatively little use of the two bridges over US Route 2. The Joiner Brook structure, an approximately 32-foot wide bridge under US Route 2, also had no animal tracks and no trail camera photos of wildlife. The Sharkeyville Stream inlet, a 60-inch CMP, had one set of mink tracks and no wildlife photos.

In short, some structures are frequently used and facilitate wildlife movement, while other structures, including bridges, do little to facilitate movement. There are presumably certain features which make some culverts or bridges hospitable and others inhospitable for animal travel. For example, the wildlife shelf under the Little River bridge is clearly a success, while the bridge over Joiner Brook is not conducive to wildlife movement. These features should be investigated, and the information used to guide future structure placement and design. The likelihood of the structure to be utilized by wildlife should be considered in planning future roadway infrastructure improvements, with higher priority given to areas that showed more wildlife activity.

A number of other structures may impede animal movement across the corridor. Chain-link fencing, woven wire fencing, Jersey barriers, and steep embankments may deter certain species from crossing roads. The potential impact to wildlife movement should be evaluated and weighed against the other benefits provided by these structures. For example, chain-link fence is impermeable to most medium and large-size wildlife species, and could result in animals spending more time on the road, increasing the chances of wildlife-vehicle collisions. This risk could be compared with the fence's benefits, such as the ability to deter humans from the roadway.

### **Importance of I-89 Segments to Connectivity**

The I-89 roadway within the study area was evaluated for its ability to facilitate wildlife crossing and improve habitat and population connectivity. The evaluation takes into account the camera and tracking results, existing landscape conditions along the corridor, and existing impediments to wildlife movement.

High priority areas: The Pineo Brook crossing and the roadway segment between Pineo Brook and the bridge over US Route 2 at Farr's Landing Road. There were relatively high numbers of wildlife crossings in this area, usage of culverts by wildlife, a perennial stream corridor, conservation land both north and south of the corridor, and moose and bear roadkill records

along this stretch of I-89. The Sharkeyville Road and stream area had a particularly high level of wildlife activity.

Medium priority areas: West of Bolton Valley Road and Joiner Brook (high value habitat north of I-89); Bolton Valley Road to Pineo Brook Road (high value habitat but fragmented by chain link fence, farmland, and residential land); US Route 2 bridge at Farr's Landing Road to Exit 10 (conservation land nearby, somewhat fragmented landscape, moderate wildlife crossings, small culverts); and the Little River bridge (an important wildlife crossing but already suitable for passage).

The Bolton Valley Road / Joiner Brook area is considered lower priority because of existing habitat fragmentation and the relatively low amount of wildlife activity observed during the study.

## **RATIONALE FOR STUDY**

The Green Mountains run north-south through Vermont and represent a nearly continuous band of habitat with some of the largest remaining unfragmented habitat blocks in Vermont (Figure 1). Perhaps the largest single fragmenting feature within this mountain range is the Interstate 89 corridor. I-89, a railroad line, the Winooski River, a local road, and scattered development traverse this corridor east to west and present a partial barrier to wildlife movement. The segment between Waterbury and Bolton Village, shown on Figure 2, is the focus of this project. North and south of this corridor are large habitat blocks with extensive upland forests along with many habitat features such as ridge lines and stream valleys, rare species and habitats, and deer wintering areas (Figure 3). Figure 1 shows that these habitat blocks are highly rated based on physical and ecological diversity, and Figure 3 shows that the habitat linkage value is mostly high.

There are many potential impediments to wildlife movement along I-89, including fencing, Jersey barriers, rock cuts, and steep slopes (Figure 4). Opportunities for wildlife to safely cross the roadway corridor are limited and take the form of road or railroad bridges, stream culverts, and perhaps other structures that were not designed or located with wildlife in mind.

How these fragmenting features and associated infrastructure affect wildlife populations and movements is not well understood, and there is interest in improving the connectivity of this habitat. Until this study, neither the permeability of the existing roads nor the potential for improved wildlife crossings had been studied at this location.

## **STUDY QUESTIONS**

This study addresses this lack of information on local wildlife occurrence, movement, and interaction with the road corridor by posing the following questions:

Is the habitat in the vicinity rich in wildlife?

Is there an edge effect zone?

Is the I-89/Route 2 corridor currently a fragmenting feature?

Is wildlife road mortality currently occurring?

Are existing culverts and bridges facilitating wildlife movement?

Would infrastructure modifications improve wildlife movements across barriers?

Figure 1. Vermont Ecological Habitat Blocks

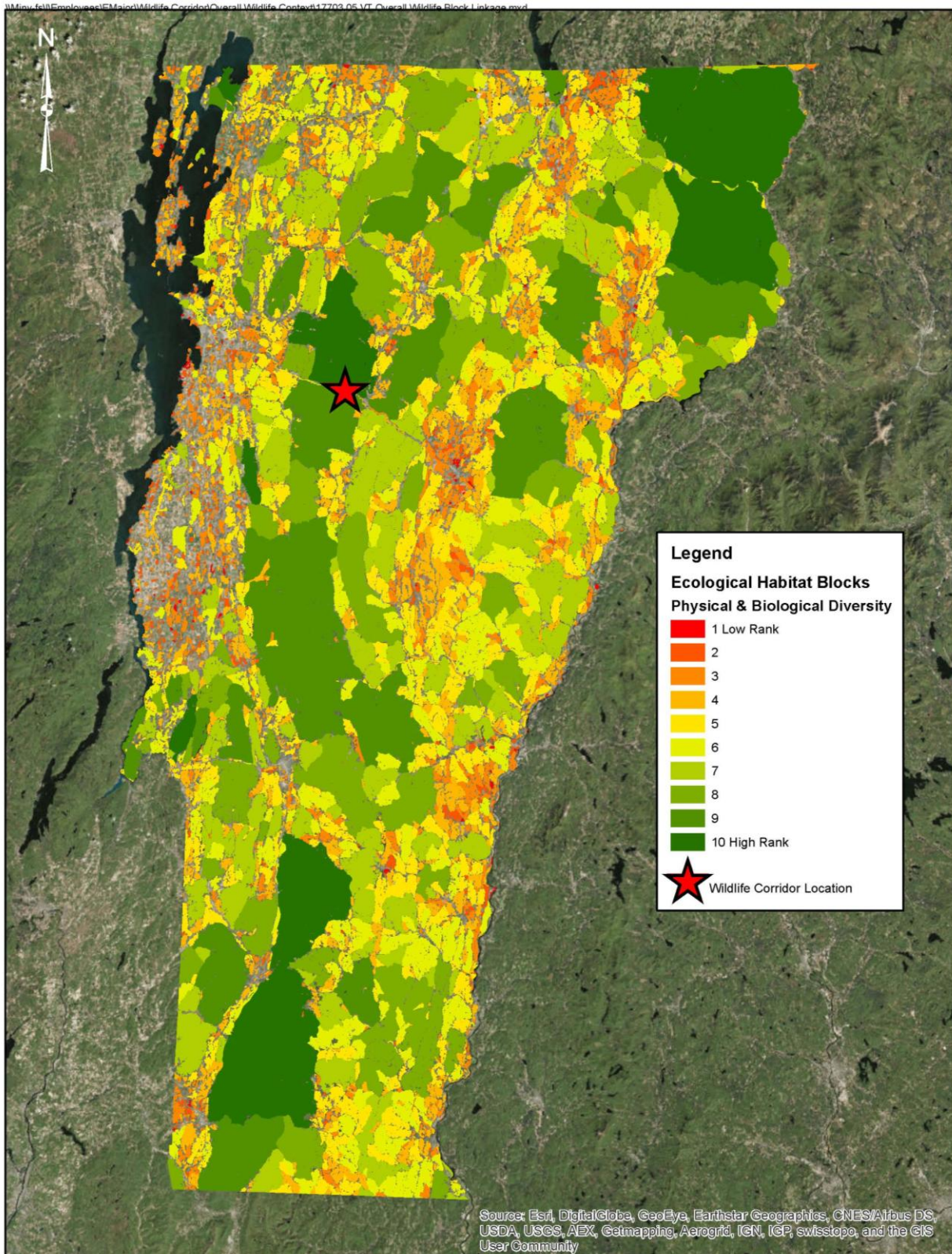

INTENTIONALLY BLANK

Figure 2. Study area with roadway study segments highlighted

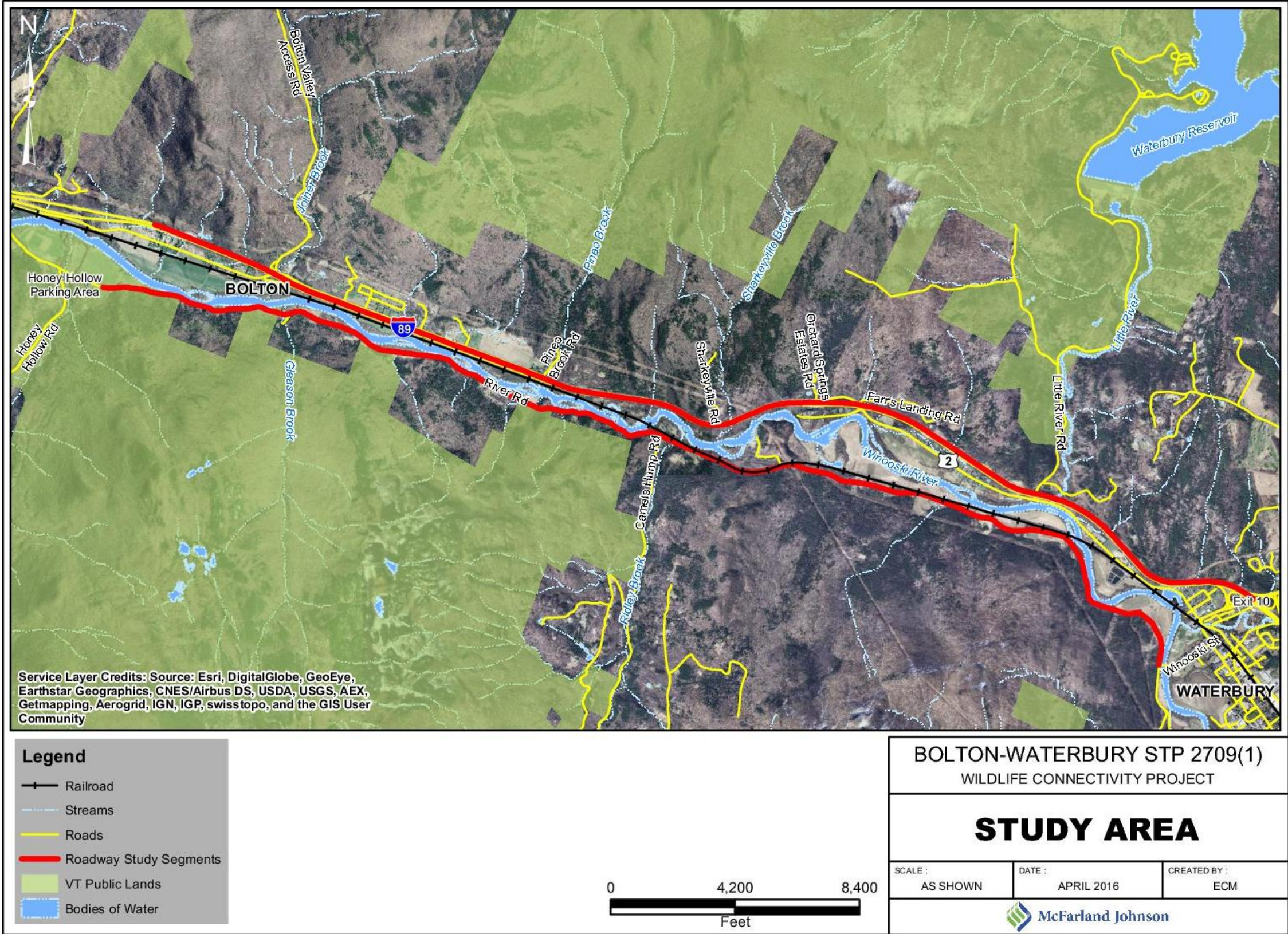



Figure 3. Previously mapped habitat features and wildlife crossing values for study area

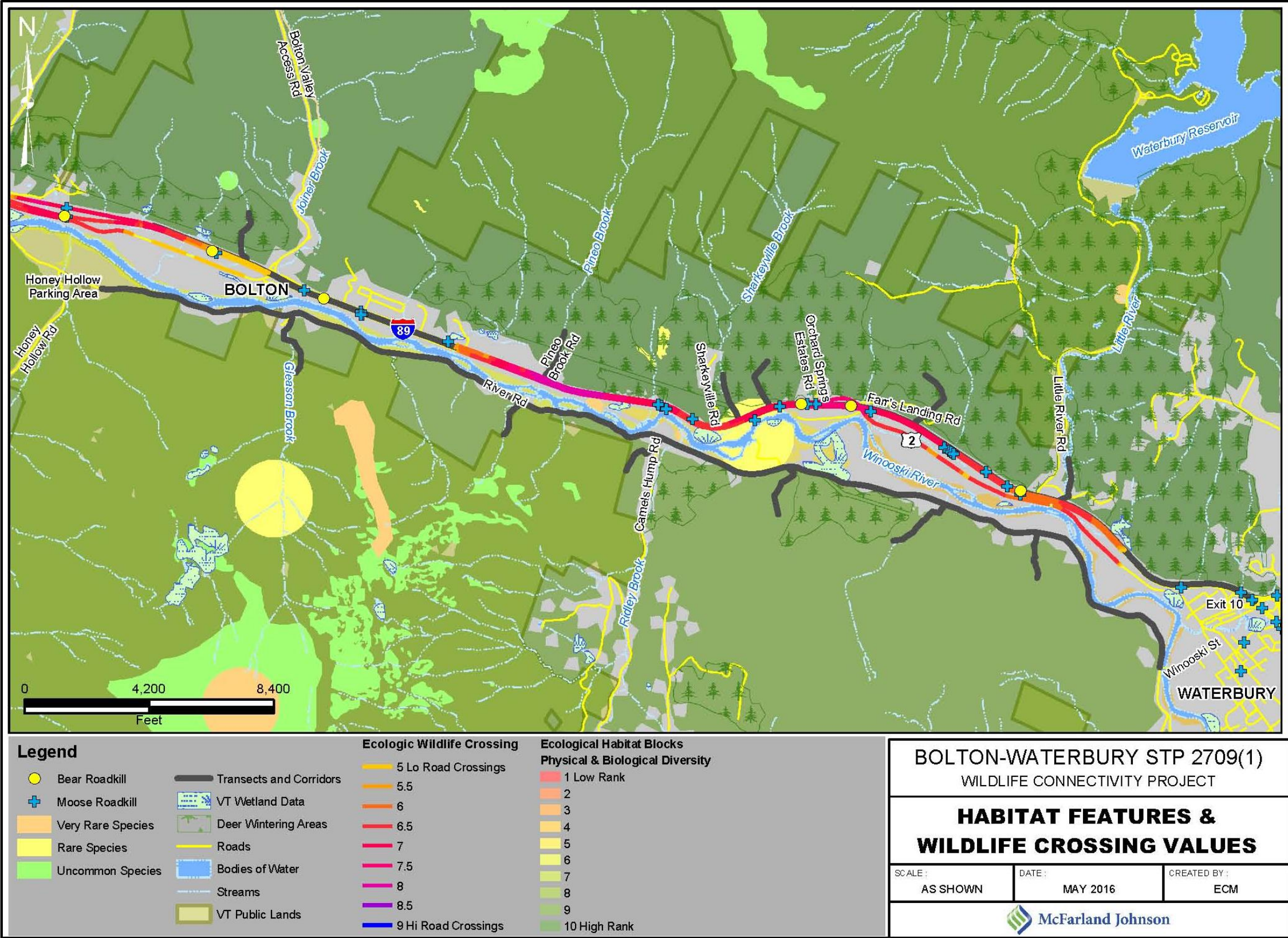

Figure 4. Potential impediments to wildlife movement across I-89

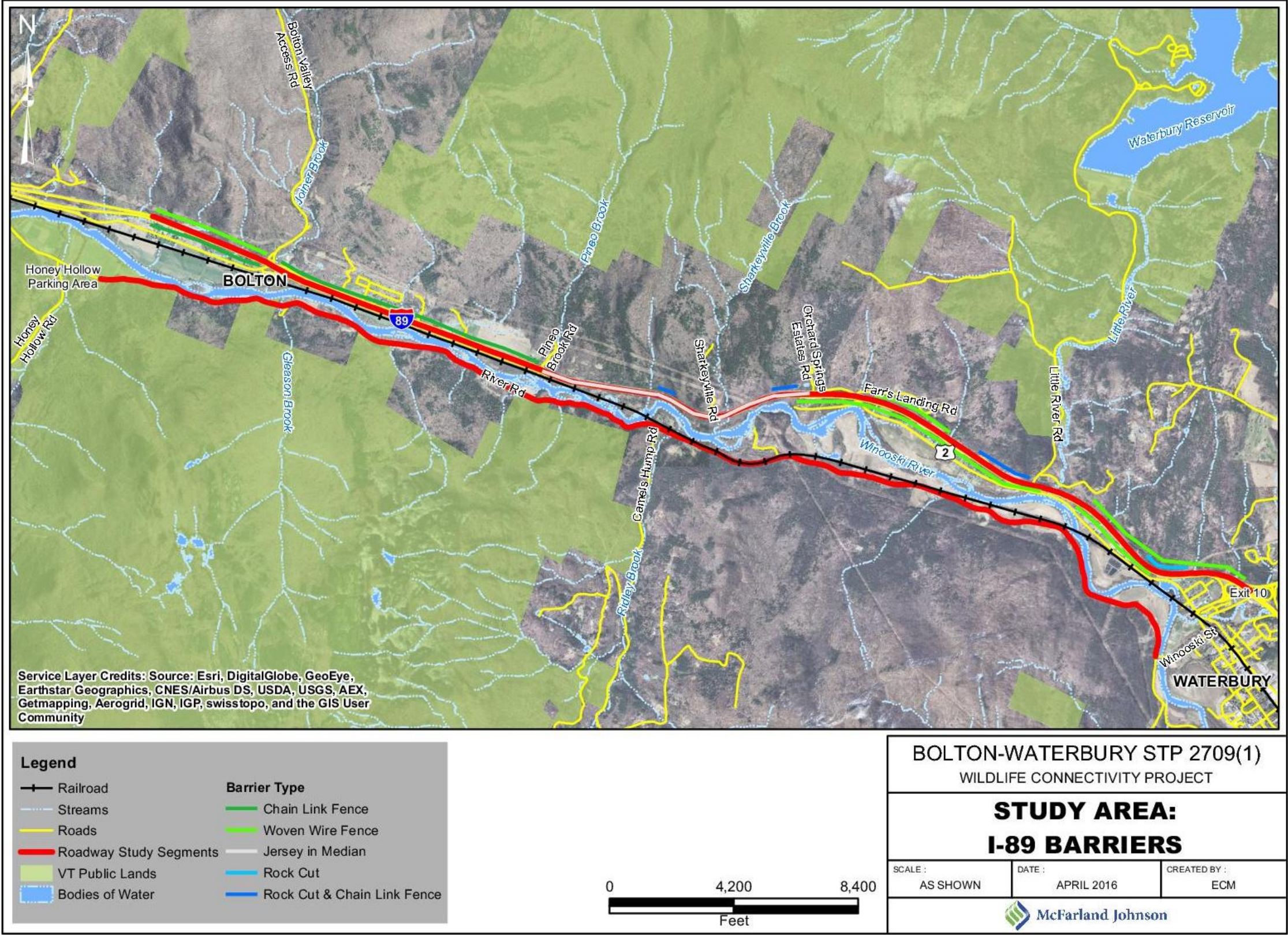
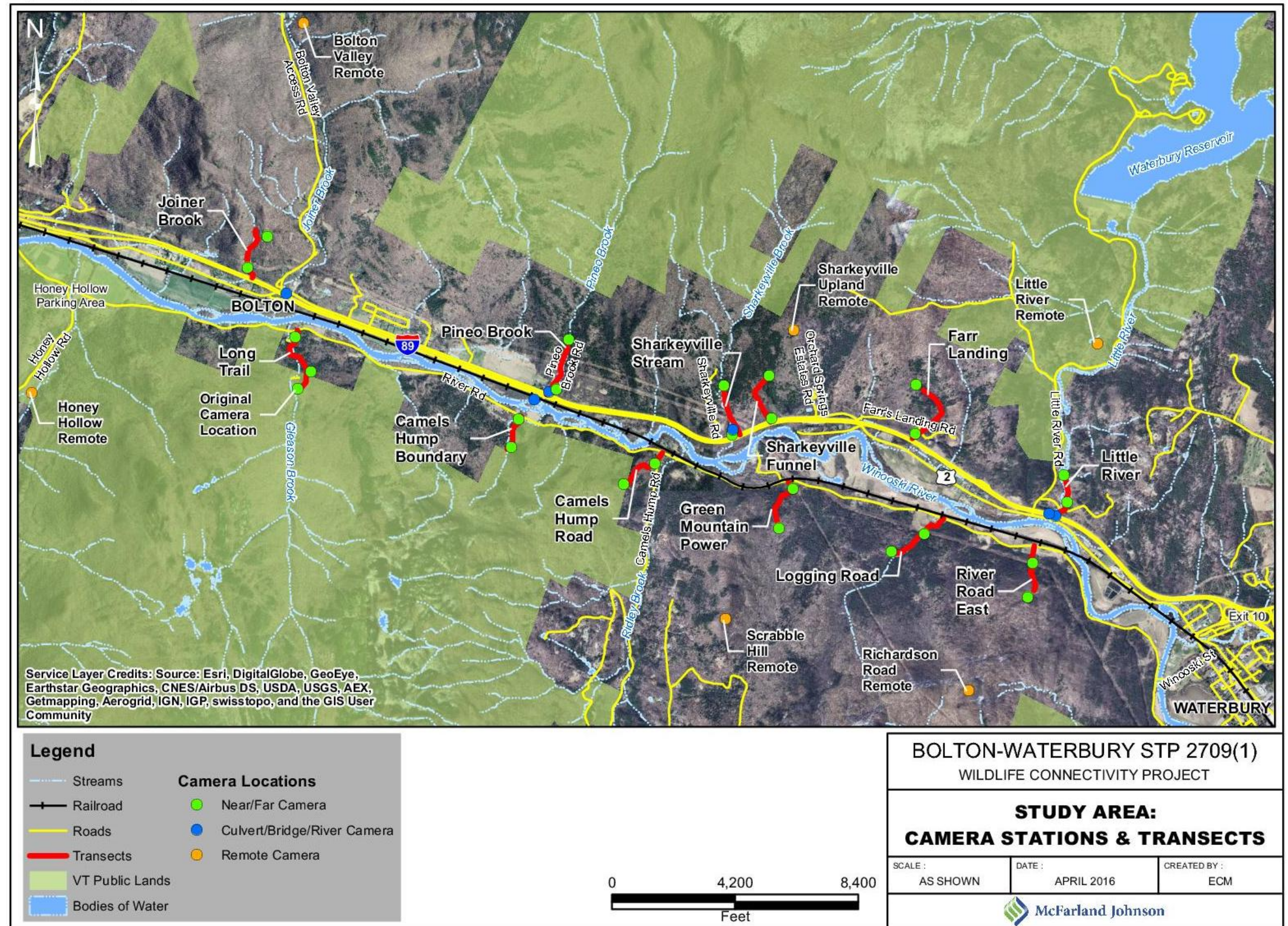

Figure 5. Transect and camera station layout



## METHODS

The study focused on medium- to large-sized, wide-ranging mammals (Table 1). The principal means of collecting information on these species and answering the study questions included wildlife cameras and winter tracking. The data were compiled and analyzed, and combined with other information such as roadkill records and GIS habitat mapping, to address the study questions.

**Table 1. Primary and secondary focus species**

<u>Primary Focus</u>	
Coyote	<i>Canis latrans</i>
American Black Bear	<i>Ursus americanus</i>
Fisher	<i>Martes pennanti</i>
Bobcat	<i>Lynx rufus</i>
White-tailed deer	<i>Odocoileus virginianus</i>
Moose	<i>Alces americanus</i>
American Mink	<i>Neovison vison</i>
River Otter	<i>Lontra canadensis</i>
<u>Secondary Focus</u>	
Red Fox	<i>Vulpes vulpes</i>
Gray Fox	<i>Urocyon cinereoargenteus</i>
Eastern Cottontail	<i>Sylvilagus floridanus</i>
Snowshoe Hare	<i>Lepus americanus</i>
North American Porcupine	<i>Erethizon dorsatum</i>
Common Raccoon	<i>Procyon lotor</i>
American Marten	<i>Martes americana</i>
Short-tailed Weasel	<i>Mustela ermine</i>
Long-tailed Weasel	<i>Mustela frenata</i>
Striped Skunk	<i>Mephitis mephitis</i>

**Wildlife cameras:** Wildlife cameras were placed at the larger existing culverts, the Little River bridge, along transects through adjacent forested habitat, and in more remote locations (Figure 5). The structures included the Little River bridge, Pineo Brook box culvert, Sharkeyville Stream corrugated metal pipe (CMP), and Joiner Brook bridge (see Appendix A, Photo Log). The

transects were situated along favorable habitats, such as stream corridors, ridge lines, or observable wildlife trails, where primary focus species were expected to be found. The transects started at the edge of forested habitat along the nearest road, and extended away from the road approximately 1,600 feet. The transects were not always straight or directly perpendicular to the road. One camera was placed near the road (the “Near” camera) and the second at the end of the transect (“Far”), which in most cases was approximately 1,600 feet from the road edge, with some variation to allow for flexibility in camera placement. There were 12 transects, 6 along the north side of the corridor and 6 along the south side, with 2 cameras each or 24 cameras total.

Six cameras were located further afield and are considered "remote" locations. These were placed at locations that appeared favorable for observations of primary focus species at distances ranging from approximately one to two miles from the nearest major road. There were an additional 5 cameras placed at the Little River bridge, 2 at the Joiner Brook inlet, 1 each at the Pineo Brook and Sharkeyville Stream inlets, and 1 along the Winooski River. To summarize, camera locations included:

- 5 cameras under the Little River bridge
- 4 cameras at 3 stream culvert inlets
- 1 camera along the Winooski River shoreline
- 24 cameras, 1 at each end of 12 transects: north and south, “Near” and “Far”
- 6 remote cameras; 3 on the north side and 3 on the south side

The camera models were the Reconyx PC800 and PC900. These models are reported to have a field of view of up to 50 feet (PC900) or up to 70 feet (PC800). They are triggered by a combination of temperature differences (such as a warm body against a cooler background) and movement across zones within the camera’s field of view. Once triggered, they take a series of 3 photographs at 1-second intervals. They continue taking photographs until the trigger ceases (i.e., the animal moves out of the field of view or becomes immobile). Cameras were placed approximately 8 to 10 feet above ground in order to avoid theft, damage or disturbance from people. Cameras were attached to a tree or, under the bridge, to a bridge abutment or pier. The camera body was angled down at a roughly 45-degree angle.

**Winter tracking:** Each transect illustrated above was visited two times each winter over two winters (2013-2014 and 2014-2015) when snow conditions were appropriate. Tracking was conducted along I-89 (five times total) and River Road / Duxbury Road (twice per winter or 4 times total). I-89 was tracked from the crossover between the I-89 barrels (Mile Marker 71.4) about 4,400 feet west of the bridge over US Route 2 in Bolton Village, to the Route 100 overpass at Exit 10 in Waterbury (Figure 4). The total I-89 segment is approximately 7.35 miles long, which equates to 97 total 400-foot segments. River Road was tracked from the

Catamount Trail parking lot (just east of Honey Hollow Road) in Duxbury to the Winooski Street intersection, equating to 7.73 miles and 102 total 400-foot segments. Tracks were identified to species (where possible), the track locations were recorded on GPS units, and it was determined whether the animal crossed the road. Along I-89 (and US Route 2, which closely parallels I-89), culverts and bridges were checked to determine whether animals crossed via those means. Tracks were particularly abundant along River Road and at times, all sets of tracks within a 50-foot stretch of road were combined and recorded at one GPS point.

## TRAIL CAMERA RESULTS

### Introduction

The camera results were tabulated and reported here as the numbers of animals photographed. This refers to the numbers of animals photographed in each different photo series or triggering event. If there was a continuous series of photos triggered by a single animal, that was counted as one animal; if there was a brief gap (seconds to a minute) between camera triggers but it was clearly the same animal, it was still counted as one animal. Two animals in the same series of photos counted as two animals. If the same individual animal was photographed at different times, each photo event was counted as an additional animal photographed.

Each camera was deployed for approximately two years, and the dates of deployment of each camera were used to convert results to a “per camera per year of deployment” basis, in the following way:

- For individual cameras, the number of animals photographed was divided by the number of years the camera was deployed and functional. For example, the Pineo Brook Inlet camera was deployed and functional for 759 days, or 2.08 years. The results for that camera were divided by 2.08 to obtain the results per camera per year. This method was used to generate the results in the *Camera Results by Station* section below.
- For tabulating results by corridor location (Culvert/Bridge, Near, Far, Remote), the cumulative results for that location were divided by the cumulative number of years of deployment of all cameras at that location. This method was used to generate the results in the Camera Results by Corridor Location section below.

Refer to the table in Appendix B, which shows camera deployment dates and calculation of camera-years.

The Winooski River camera results are not included in the Corridor Location results, since that camera station does not fit into the Corridor Location scheme (Culvert/Bridge, Near, Far, and Remote).

Mice and domestic animals are excluded from this analysis.

## Overall Results (combined results of all cameras)

Over 116,000 wildlife photos were taken by the 40 trail cameras over the two years of the study. The results of all camera data combined were tabulated by species and are shown in Table 2 in order of abundance within each focus grouping. White-tailed deer were by far the most abundant species, with 84% of all animals observed and nearly 20 times the next most abundant species, coyote. Relatively low numbers of fishers and bobcats were photographed, and no mink or otter were photographed. During winter tracking, there were tracks of smaller animals within range of the cameras that were not captured in photographs. It may be that animals were either too small, moving too fast to be captured on camera, or moving in a direction relative to the field of view that would not cause a trigger.

**Table 2. Numbers of animals of all species photographed at all cameras**

Common Name	Total Number*
<b>Primary Focus</b>	
<b>White-Tailed Deer</b>	<b>5102</b>
<b>Coyote</b>	<b>264</b>
<b>Black Bear</b>	<b>114</b>
<b>Moose</b>	<b>65</b>
<b>Fisher</b>	<b>13</b>
<b>Bobcat</b>	<b>9</b>
<i>Secondary Focus</i>	
<i>Fox</i>	<i>51</i>
<i>Raccoon</i>	<i>34</i>
Non-Focus	
Wild Turkey	207
Waterfowl	83
Songbird	40
Unknown	31
Squirrels	29
American Beaver	5
Raptors	4
Heron	3
Chipmunk	3
Groundhog	2
Virginia Opossum	1
<b>Grand Total</b>	<b>6080</b>

\* Number of animals indicates the number of different times animals were photographed; the results do not necessarily indicate or correlate with the actual number of animals present in the area. These are the total numbers of animals photographed and are not divided by camera-year.



## Camera Results by Station

The graphics below show the trail camera results for all camera stations. Results are shown for individual focus species. Although it cannot be known whether the results reflect the numbers of animals in these areas or repeated observations of a few animals, the results presumably give an indication of the relative abundance of each species across the project area.

In general there appears to be higher numbers of focus species in the eastern half of the study area. Looking at the individual primary focus species, in order of abundance:

- Deer (Figure 6) were the most common species overall and were found at all but a few camera stations. Deer were most abundant at the Near camera stations, especially on the north side of the corridor.
- Coyotes (Figure 7) were also found at most camera stations but had pockets of abundance: on the Joiner Brook transect (where they also crossed I-89 in winter), Farr Landing Far, and Little River Remote (Figure 6). Overall, they were more common at the Near than the Far stations, but were most abundant at the Remote stations, primarily due to the Little River Remote station.
- Black bears (Figure 8) were also found throughout the study area, and were most frequently photographed at Green Mountain Power Near, Richardson Road Remote, and Little River Remote. Overall they were more common at the Near than the Far stations, but were most abundant at the Remote stations.
- Moose (Figure 9) were most common in the eastern half of the study area, which is consistent with roadkill data discussed below. They became more abundant as one moved away from the road edges, displaying the clearest evidence of edge effect of all the focus species.
- Fishers and bobcats (Figures 10 and 11), based on a relatively small number of photographs, were most abundant at the Far and Remote camera stations. Fishers were only photographed at one Near camera, at no culvert or bridge cameras, and at only one camera in the western half of the study area. Bobcats were photographed at two Far cameras, one Remote camera, and the Little River bridge, all on the north side of the corridor.

Figure 6. Number of deer photographed at each camera station (per camera/year)

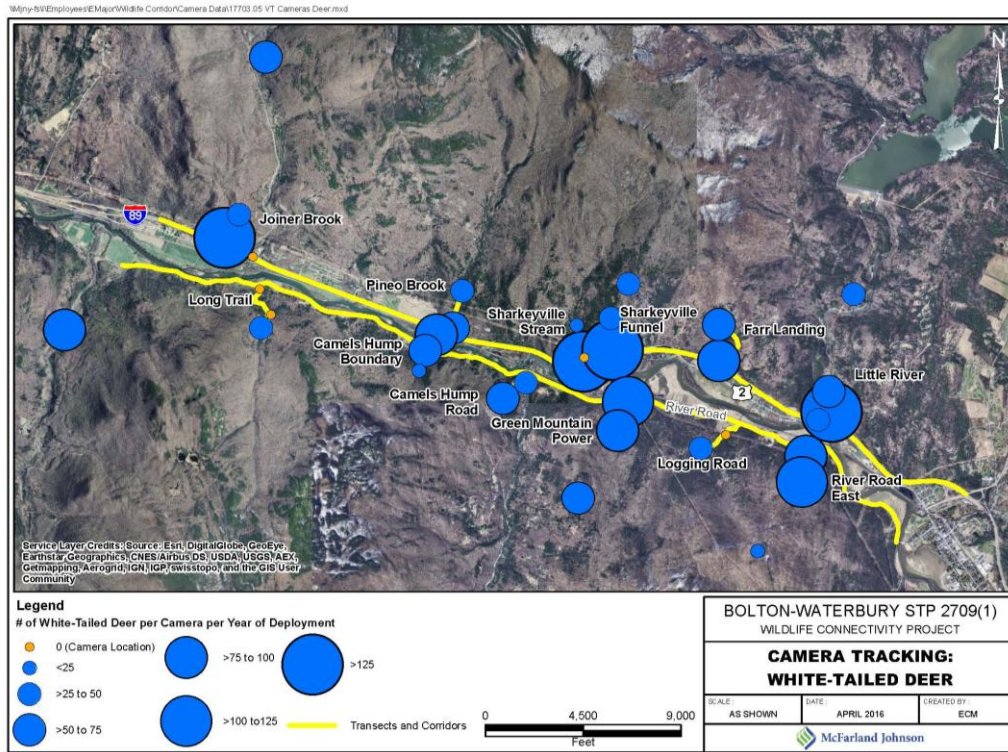

Figure 7. Number of coyotes photographed at each camera station (per camera/year)

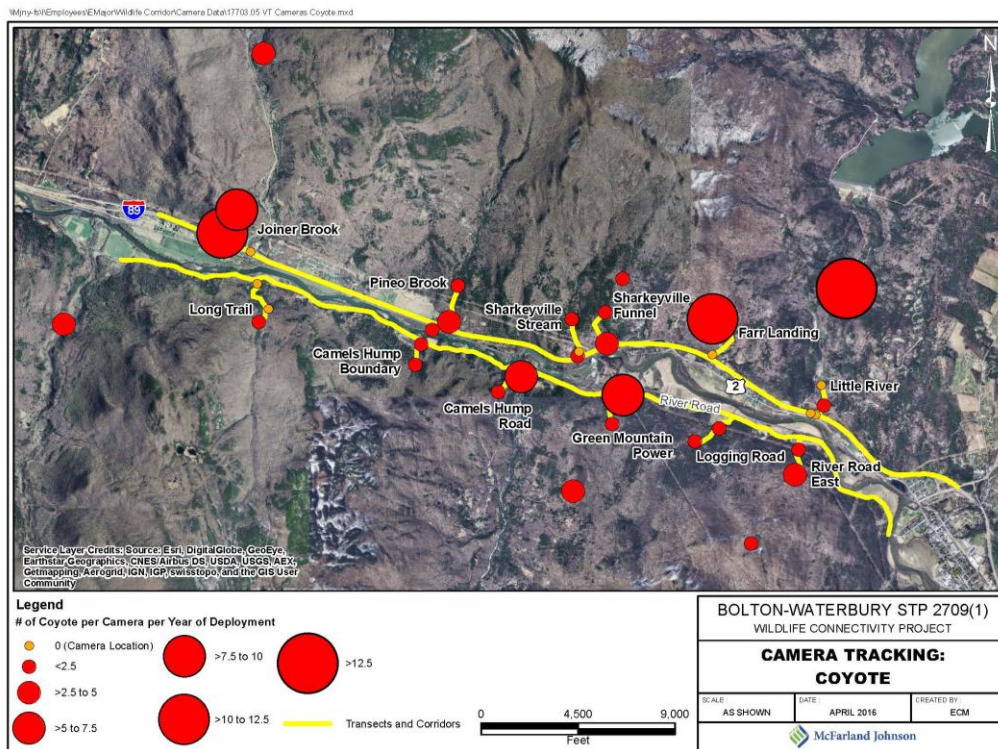

Figure 8. Number of black bears photographed at each camera station (per camera/year)

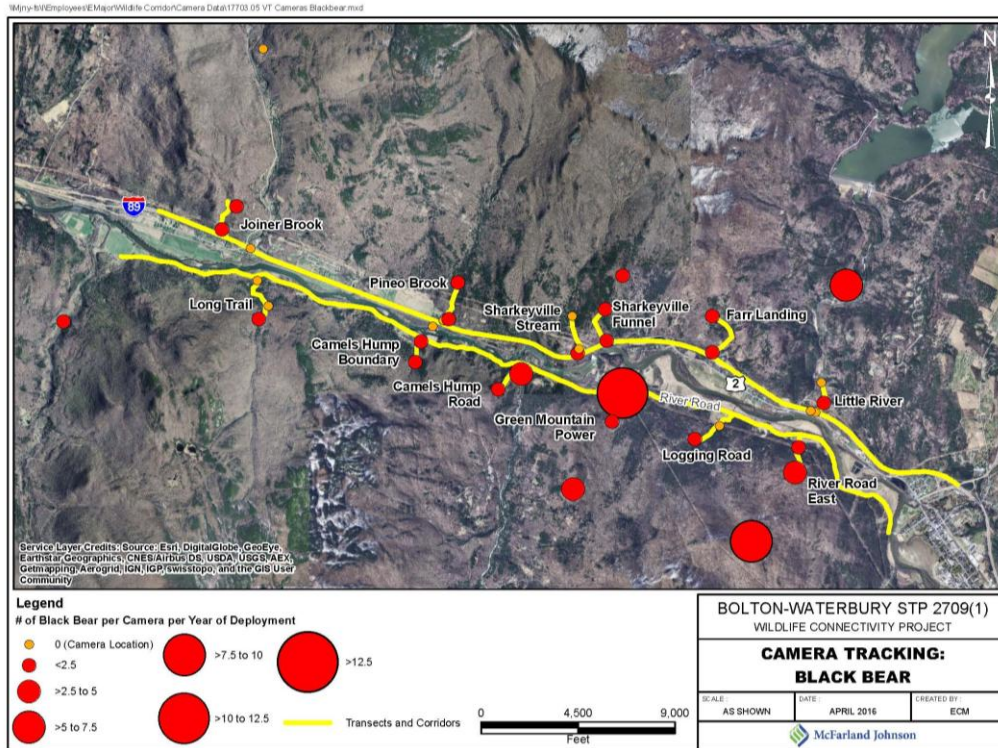

Figure 9. Number of moose photographed at each camera station (per camera/year)

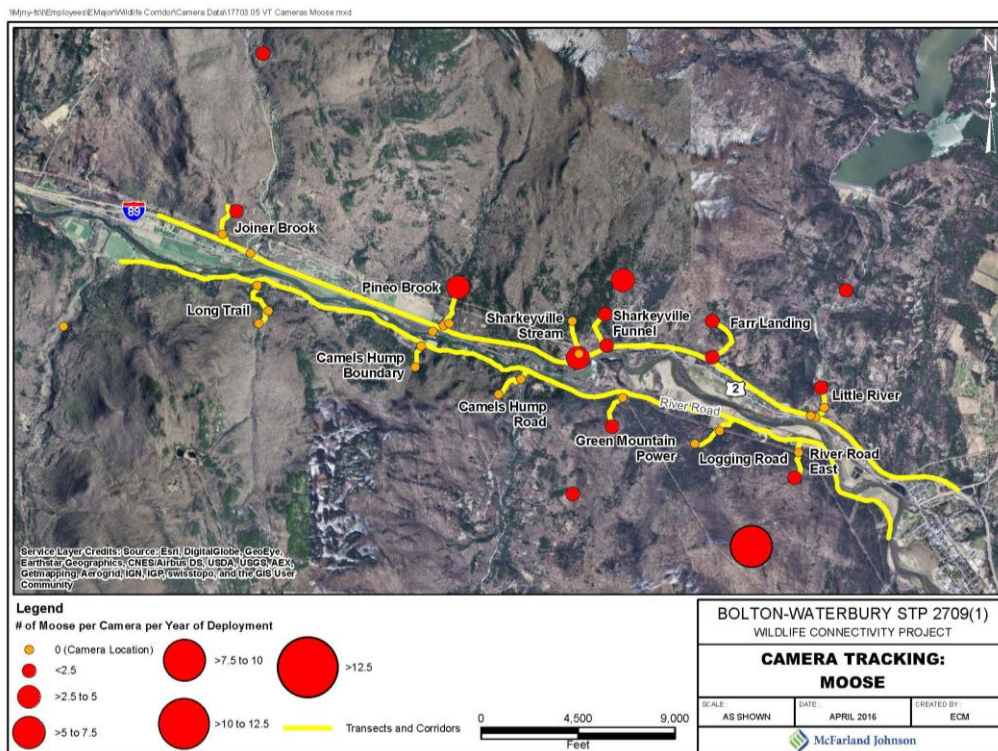

Figure 10. Number of fishers photographed at each camera station (per camera/year)

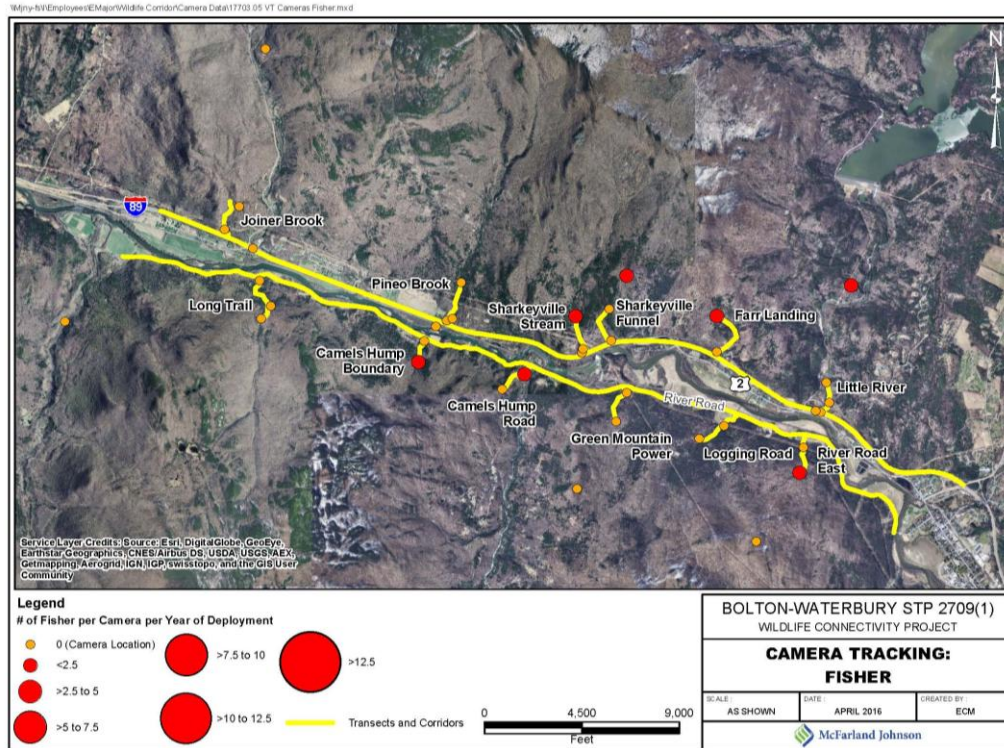

Figure 11. Number of bobcats photographed at each camera station (per camera/year)

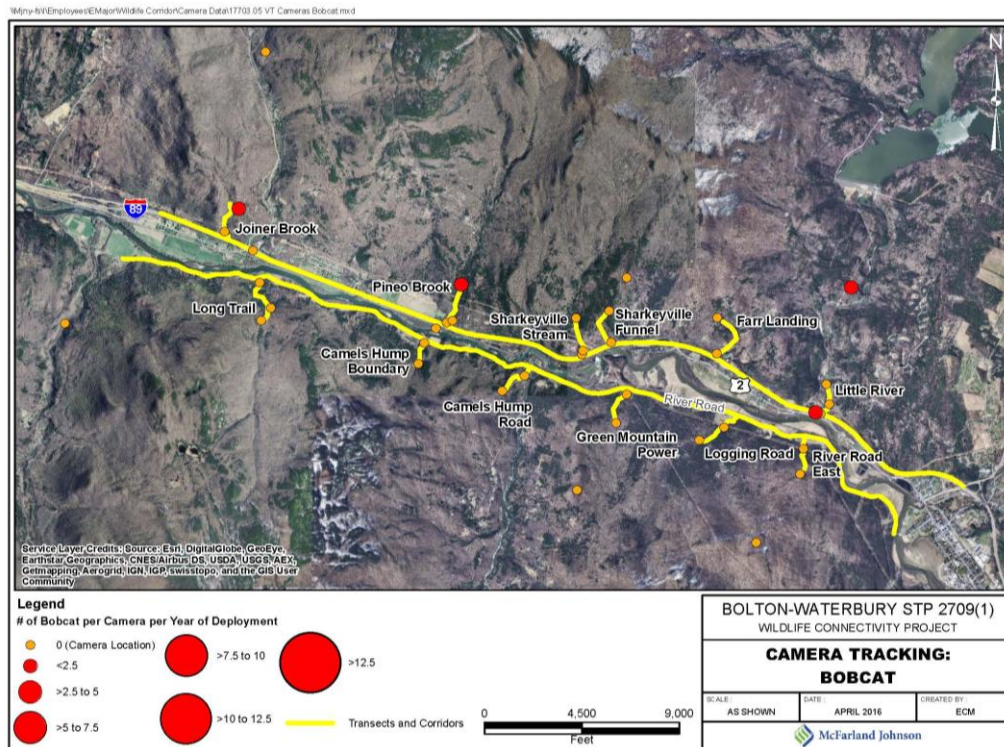

Figure 12. Number of foxes photographed at each camera station (per camera/year)

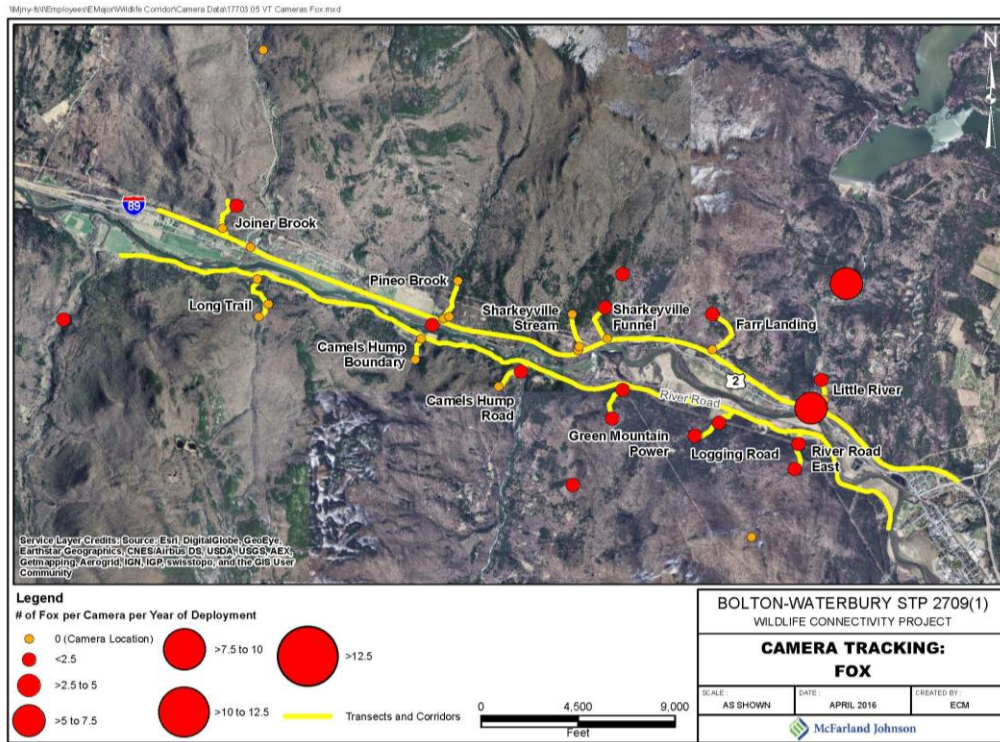
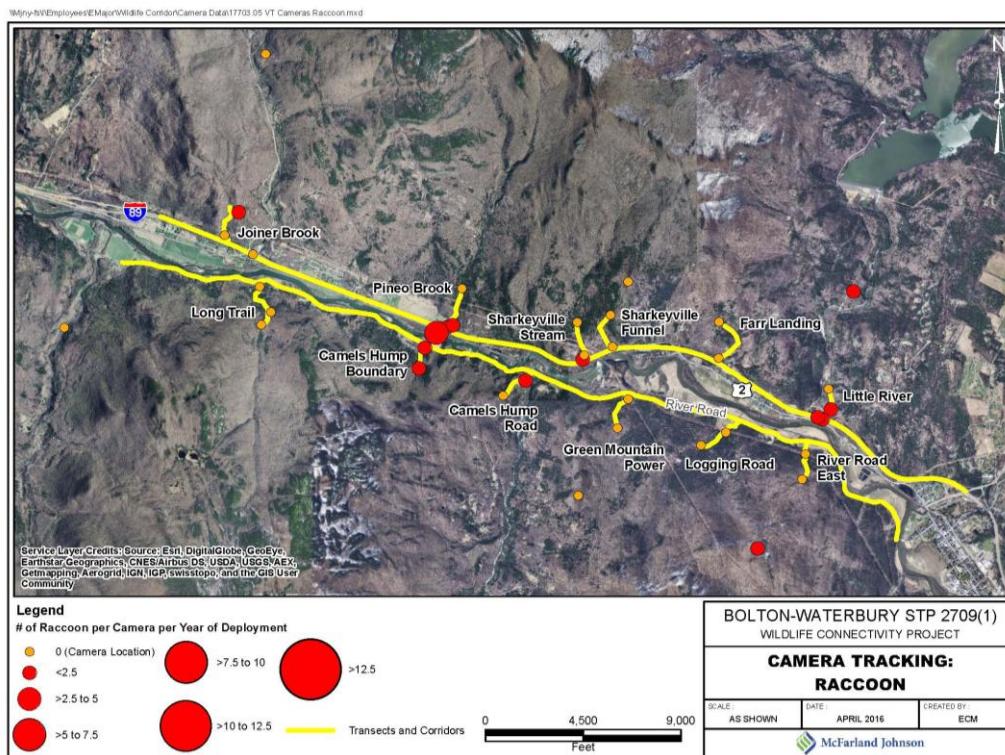

Figure 13. Number of raccoons photographed at each camera station (per camera/year)



## Camera Results by Corridor Location

Results were tabulated by corridor location, which was divided into four locations with respect to the road corridor:

- Bridges and culverts, where cameras were placed under bridges or at culvert inlets;
- Near camera stations, which were placed near the forest edge along the closest major road;
- Far camera stations, which were located roughly 1,200 to 2,000 feet from the closest major road; and
- Remote camera stations, which were located 0.6 to 1.7 miles from the closest study road segment (but closer in some cases to smaller local roads).

The results are reported in terms of numbers of animals photographed per camera per year. Because of the high numbers of deer, results are reported both with and without the deer numbers included. Refer to Figures 14 through 25 below.

In all of the figures, one can see the relatively low numbers of animals photographed at the culverts and bridges. Most of the animals in this category were photographed under the Little River bridges. There was little use of the other structures with cameras: none at all photographed at the Joiner Brook bridge or Sharkeyville Stream culvert, and 13 deer and one raccoon at the Pineo Brook culvert. Based on winter tracking results discussed further below, some smaller animals, such as mink, were missed by these cameras. Winter tracking also showed there was a small amount of movement under the two bridges over US Route 2, where no cameras were placed.

The numbers of all species, of primary and secondary species combined, and of primary species only, all paint a similar picture. When deer are included in the analysis, the Near cameras have the highest numbers, and the Far and Remote cameras have comparable numbers. However, when deer are excluded, the Near and Far cameras have similar numbers, and the Remote cameras have higher numbers of photographed animals.

The distributions of individual focus species reflect the distributions at camera stations shown in Figures 6 to 13 above: few animals photographed at most culvert and bridge cameras, a high abundance of deer at the Near cameras, and for other animals, a general trend of higher abundance at Remote cameras.

**Figure 14. Number of animals/camera/year - all species**

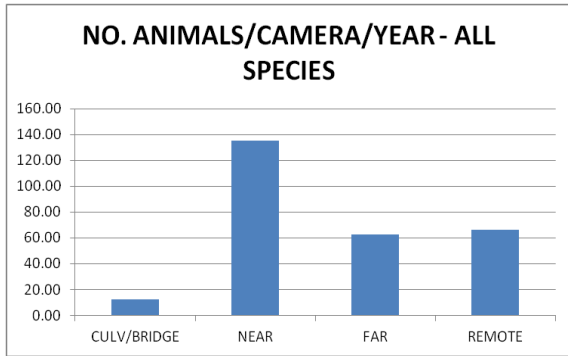

**Figure 15. Number of animals/camera/year - all species excl. deer**

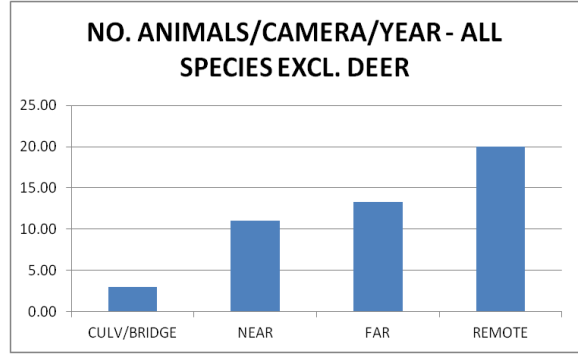

**Figure 16. Number of animals/camera/year – primary and secondary species**

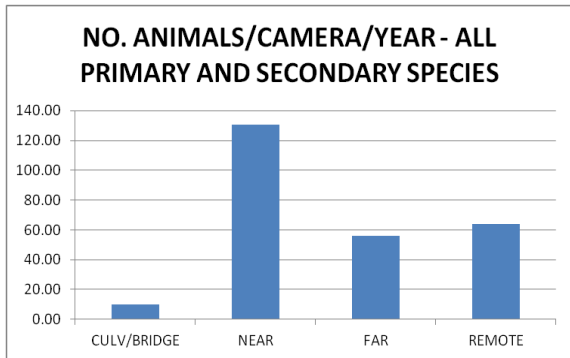

**Figure 17. Number of animals/camera/year – primary and secondary species excl. deer**

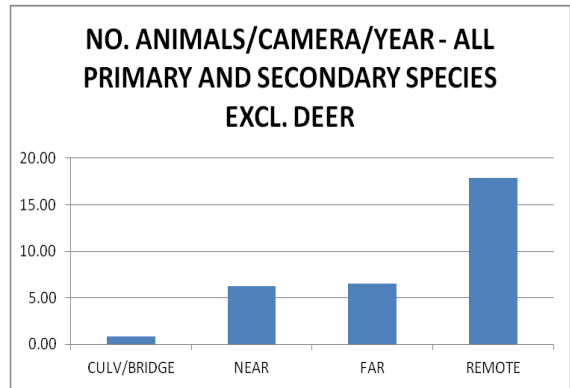

**Figure 18. Number of animals/camera/year - primary species**

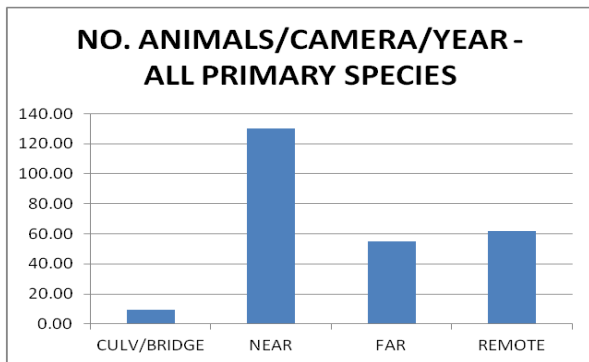

**Figure 19. Number of animals/camera/year - primary species excl. deer**

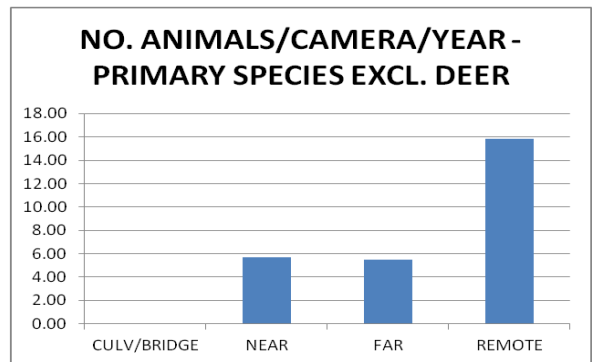

**Figure 20. Number of animals/camera/year - deer**

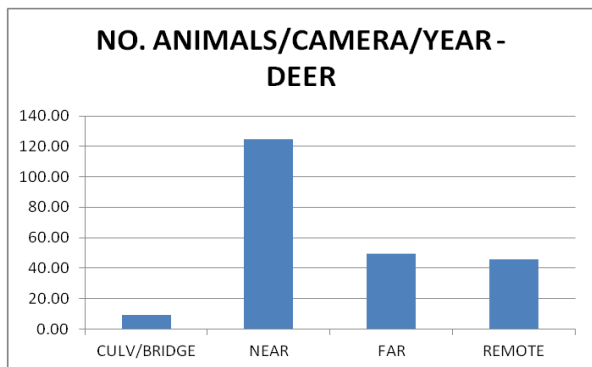

**Figure 21. Number of animals/camera/year - coyote**

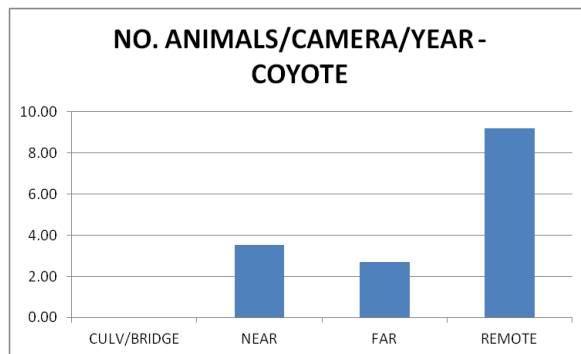

**Figure 22. Number of animals/camera/year - black bear**

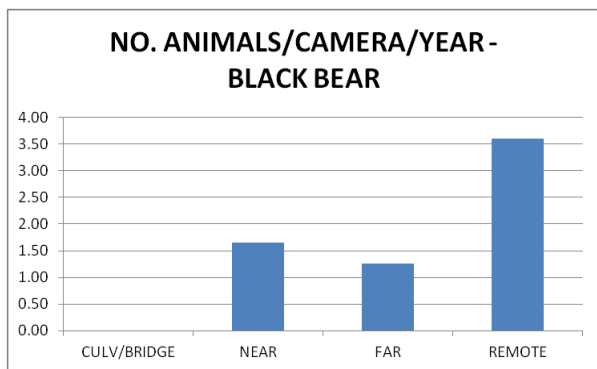

**Figure 23. Number of animals/camera/year - moose**

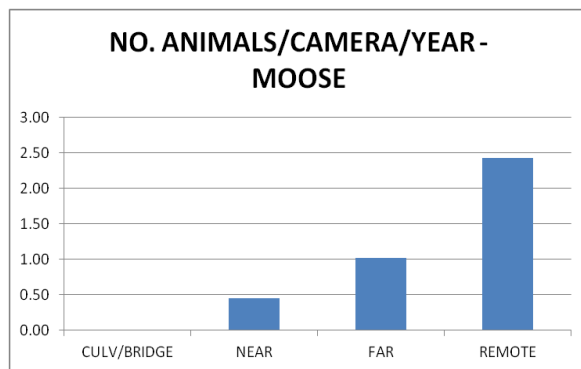

**Figure 24. Number of animals/camera/year - fisher**

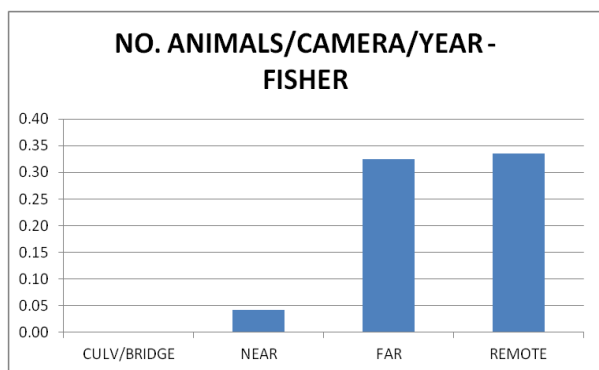

**Figure 25. Number of animals/camera/year - bobcat**

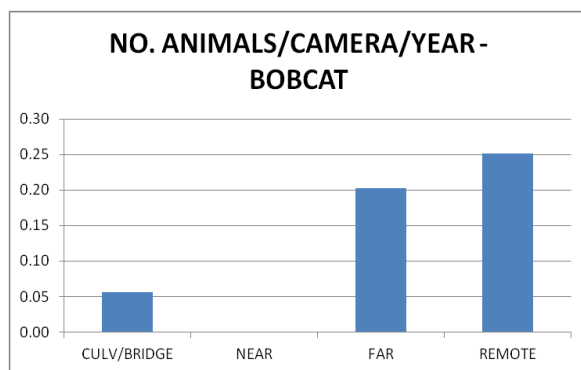



# WINTER TRACKING RESULTS

## Introduction

For both transect and road tracking, data are expressed as the number of track sets per 400 feet per 90 days. Table 3 below summarizes the numbers of tracking rounds, antecedent track nights, and lengths of transects. Appendix C provides detail on the lengths of each transect and segment and the conversion factors used.

- A “track” is a series of footprints in the snow produced by one animal that creates a curvilinear track through the snow.
- “Number of tracks” means the number of individual tracks which intersected the transect line or entered the road. For transects, each time a track crossed the transect line, a track was counted. For road tracking, each time the animal entered the pavement was counted, and it was determined whether the animal crossed to the other side.
- “Antecedent track nights” is the numbers of nights of good track-producing snow prior to each survey. These were estimated based on weather reports and observation of snow conditions while tracking. The track numbers were divided by the number of antecedent track nights, then multiplied by 90 to express results in tracks per 90 days or one winter season.
- All tracks were assigned to distance categories based on their straight-line distance from the road where the transect originated (I-89, US Route 2, or River Road). (A few more lightly traveled roads, including Pineo Brook Road, Sharkeyville Road, Farr’s Landing Road, and Little River Road, were closer to some transects than the busier roads but were not believed to have as strong of an edge effect.) The distance categories were each 400 feet long, beginning at the edge of the road shoulder. There were five distance categories (0 to 400 feet, 401 to 800 feet, etc.). Because transects were not perpendicular to the road, the length of each transect within the distance categories varied. In order to express results in terms of 400 feet of transect, the lengths of each transect within each distance category were measured (using GIS). The track numbers were divided by this figure to convert the tracking data to a per 400 feet basis. Since most transects did not extend 2,000 feet from the road edge, the furthest distance category (1601-2000 feet from road) had only half as much transect length as the other categories. The results for this segment were heavily skewed by two locations with high numbers of deer, so results

from the 1601-2000 feet category were not included in the analysis. The tracking effort, antecedent track nights, and conversion factors are listed in Table 3.

- As an example, the Camels Hump Boundary transect was tracked four times. There were 3 consecutive nights of good track-producing snow before the first visit, and 2 nights on each of the other 3 visits, for a total of 9 antecedent track nights. The data were divided by 9 to obtain a per-night basis, then multiplied by 90 to convert to a 90-day basis (one winter season). In the first segment of the transect, there was 408 feet of transect, or 1.02 times a 400-foot segment, within 400 feet of the road. The total number of tracks within this segment was therefore divided by 1.02 to express the results per 400 feet. Refer to Appendix C for the lengths of each transect and segment and conversion factors used.
- For road tracking, the location of each set of tracks was determined using a GPS unit. To make data collection more manageable, during the 2015 River Road tracking, tracks were counted in 50-foot lengths of transect lines, with the location entered as the midpoint of the 50-foot line. Using GIS, the roads were then divided into 400-foot segments and the number of tracks within each segment was tabulated to obtain tracks per 400-foot segment.
- Mice and domestic animals were not counted on all tracking efforts and are excluded from the analysis.

**Table 3. Comparison of road and transect tracking effort**

	<b>I-89</b>	<b>River Rd</b>	<b>Transects</b>
Number of Rounds of Tracking	5	4	4
Total Number of Antecedent Track Nights*	13	9	9 or 10 (varied by transect)
To Convert Results to a 90-Day Basis, Multiply by:	90/13	90/9	90/9 , 90/10
Length of Road or Transects (Miles)	7.3	7.7	4.09
Number Of 400-Foot Segments	97	102	47

\* Total number of nights with good track conditions prior to survey days

## Transect Tracking Results: Distance from Road

The following figures show the numbers of tracks found within each of the four distance-from-road categories. Overall, the least number of species was found within the segment closest to the road edge, and the greatest numbers were found in the next segment. Deer were most abundant at the furthest segment (1201-1600), while coyote and fisher were most abundant within the second segment (401-800). There were also large numbers of deer further out, in two of the 1601-2000 foot segments, which were not included in the analysis. It is not clear how these spatial patterns relate to the roads. It is possible the road is a repellent while the forest edge is an attractant.

**Figure 26. Number of track sets/400 feet/90 days - all species**

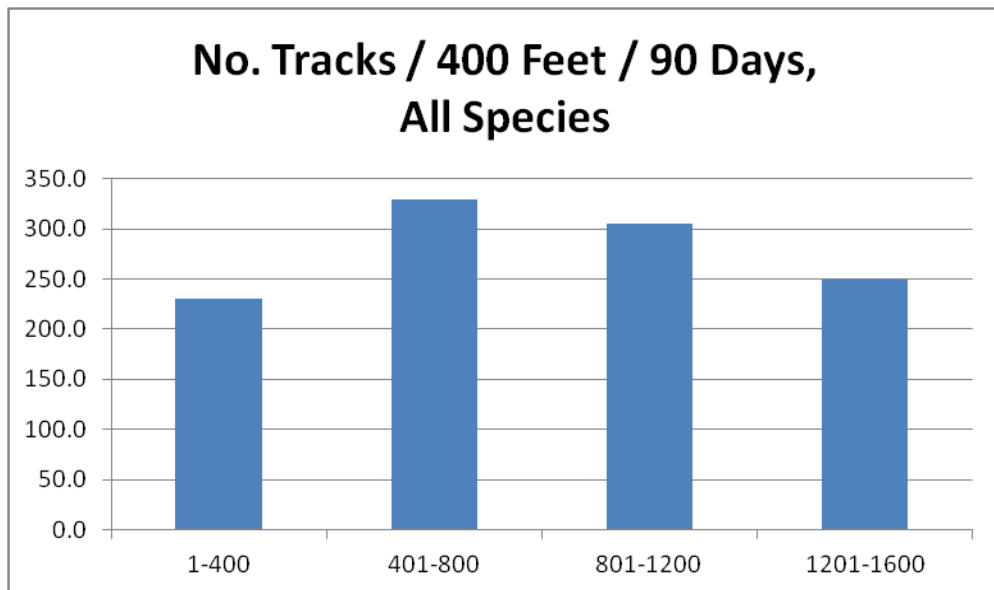

Figure 27. Number of track sets/400 feet/90 days – primary and secondary species

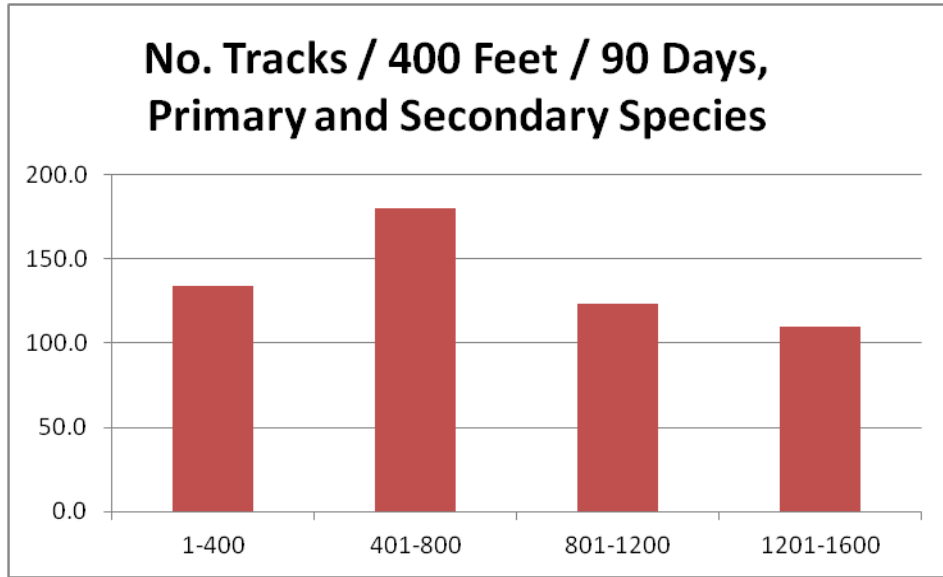

Figure 28. Number of track sets/400 feet/90 days - primary species

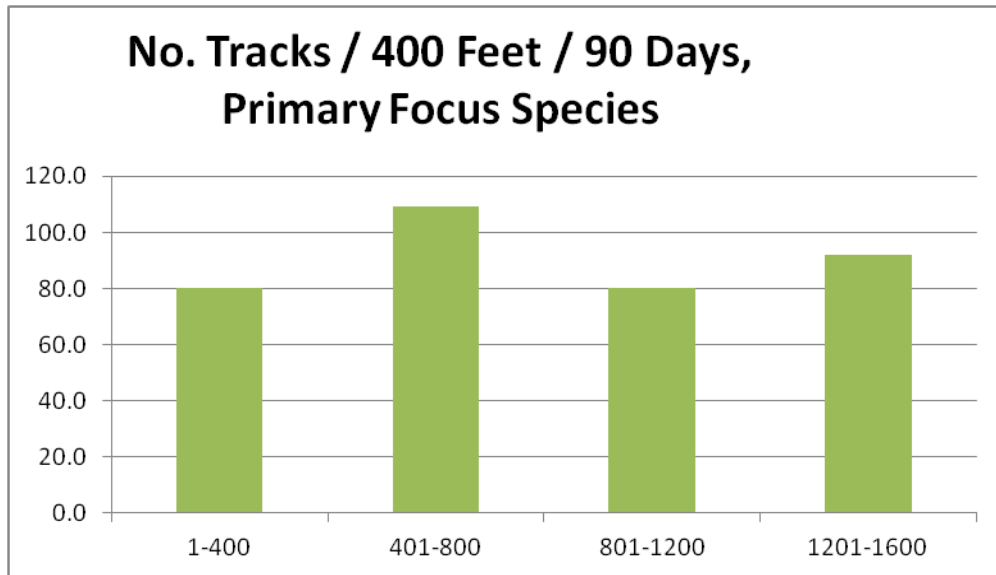

Figure 29. Number of track sets/400 feet/90 days – primary species excl. deer

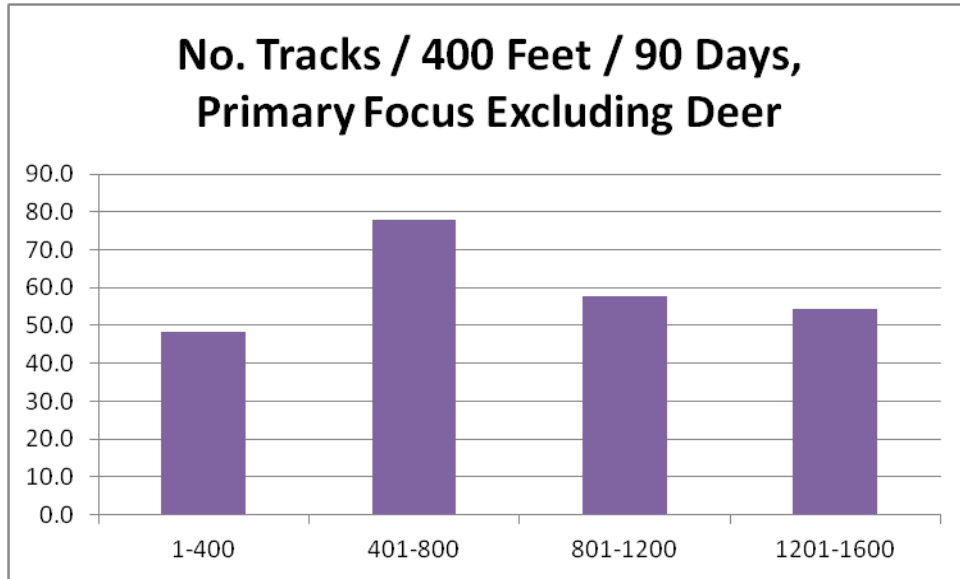
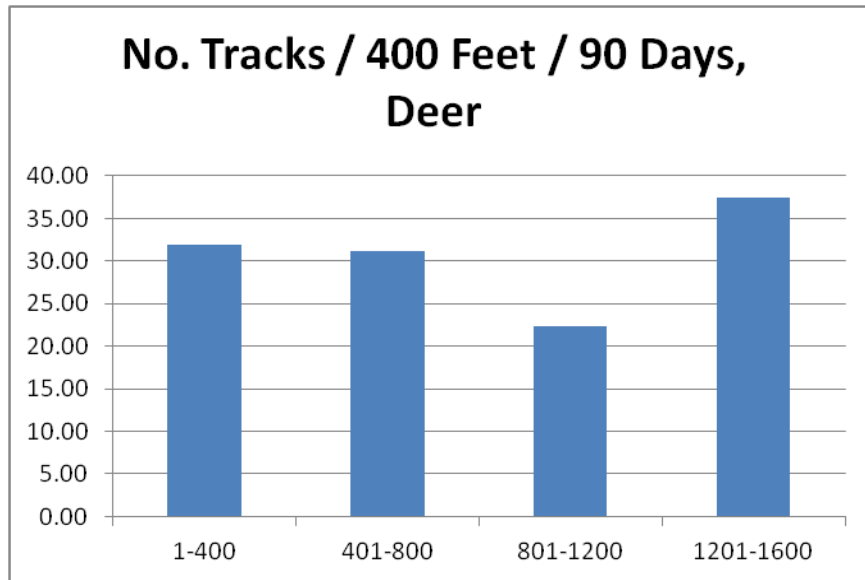
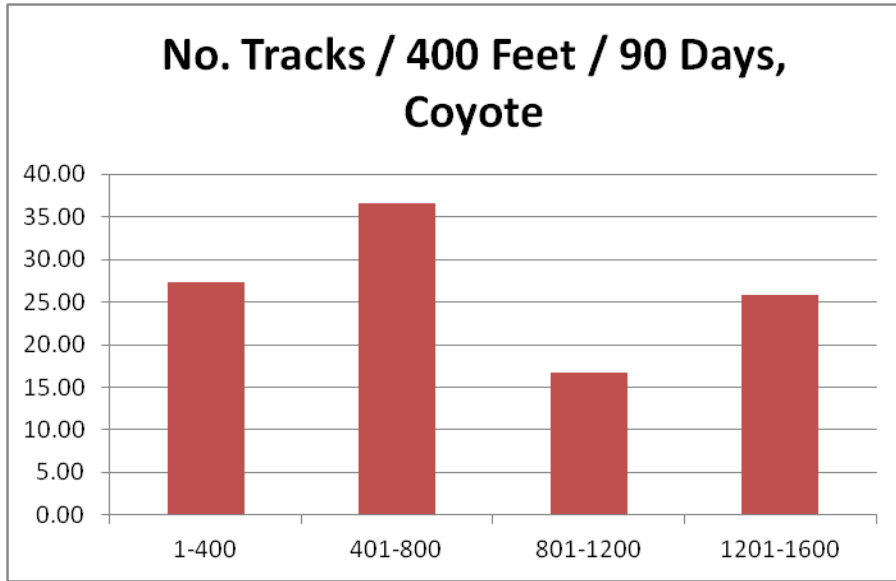

Figure 30. Number of track sets/400 feet/90 days - deer



**Figure 31. Number of track sets/400 feet/90 days - coyote**



**Figure 32. Number of track sets/400 feet/90 days - fisher**

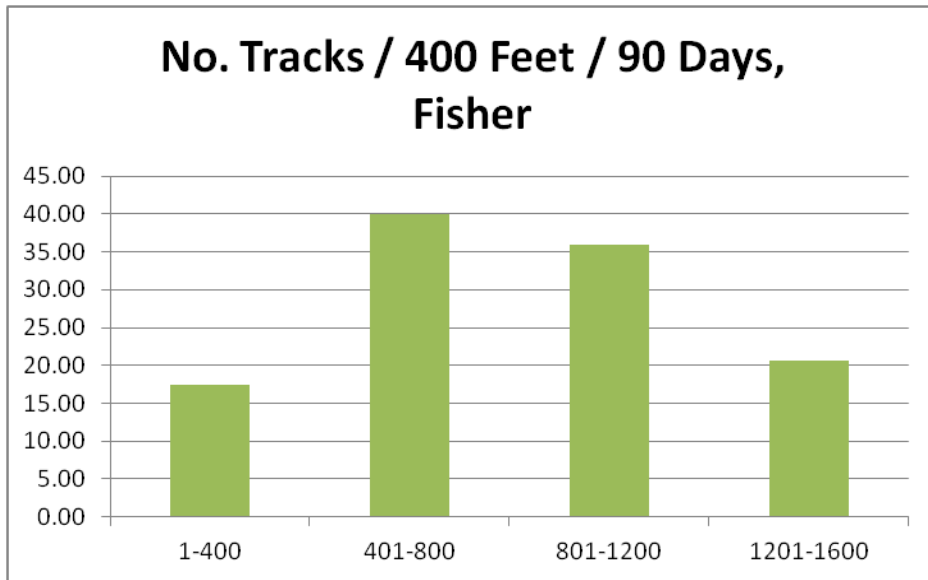

## Road Tracking Results: Overall

During I-89 tracking efforts, bridges and culverts were checked for tracks, and an effort was made to determine whether animals fully crossed the road, either over the surface or via structures. Eight dead animals, presumably killed in vehicle collisions, were found, but were not included in the results.

A total of 285 animals crossed the road at least part way, 203 or 71% over the road surface, 53 or 19% via culverts, and 29 or 10% via bridges (Table 4). There were 211 animals crossing both barrels of I-89 (and some US Route 2 also), 130 over the road surface, 29 under bridges, and 52 via culverts. There were 74 that crossed part way, 73 over the surface and 1 in a culvert. Most of the bridge crossings were at the Little River bridge, with a few tracks observed under the US Route 2 bridges. Animal species and crossing locations are shown on Figure 13.

On River Road, culverts were very small, and all observed tracks were from animals crossing over the road surface. Only animals that fully crossed the road were counted.

**Table 4. I-89 winter tracking summary**

Track Location	Total Number of Track Sets	Percent of Total
Total tracks on or under I-89	285	100%
Road surface	203	71
<i>Crossed both barrels</i>	<i>130</i>	
<i>Crossed part Way</i>	<i>73</i>	
Culvert	53	19
<i>Crossed both barrels</i>	<i>52</i>	
<i>Crossed part Way</i>	<i>1</i>	
Bridges	29	10

## **Road and Transect Tracking Results: Track Density**

### ***Comparison of Roads and Transects***

The numbers of tracks varied among transects and roads, as well as among transect and road segments. To allow comparison among the roads, transects, and segments, the data were converted to the same standardized units used for transect tracking analysis: tracks per 400 feet per 90 days. For purposes of analysis, the roads were divided into continuous 400-foot segments. For the transects, the same 400-foot distance-from-road categories were used as described above.

The results were calculated in the following way, using I-89 track numbers as an example. The track numbers of animals that crossed both barrels of I-89 were pooled (211 tracks), including animals crossing over the road surface to the opposite side, passing under bridges, or passing through culverts. The track numbers were divided by the number of antecedent track nights (13) to obtain per-night numbers (16.2), multiplied by 90 to convert the data to a per-90-day basis (1,461), and divided by the number of 400-foot road segments (97) to convert to a per-400-foot basis (15.1 tracks per 400 feet per 90 days). The same calculation was carried out for all primary focus species, primary plus secondary species, and the five most common focus species. All full crossings, whether over the road surface or through structures, were included. Animal crossings under bridges and through culverts are described and illustrated in more detail in the next section of the report.

The transects are included in this analysis to provide a basis for comparing wildlife road crossing density with wildlife movements in typical forested settings. In comparing the two roads and transect results, it is important to acknowledge the differences between them. The broader I-89 / Winooski River / River Road corridor has a number of different land uses and possible impediments to wildlife movement, including a railroad line, farm fields, and developed land. I-89 has two barrels, each with two lanes in each direction, a median between, Jersey barriers in places, and right of way fencing. I-89 is also immediately adjacent to US Route 2, a railroad line, and the Winooski River in portions of the study area. River Road is a two-lane road with forest and occasional farm fields and human dwellings along its edge. In most places the tree canopy overhangs the road on both sides. The culverts are believed to be small and impermeable to most wildlife.

The transects follow a single line through predominately forested habitat. In some places they follow woods roads which are much less travelled than the paved roads and have closed canopies and unpaved surfaces. The transects do not necessarily represent undisturbed forested habitat, as they begin near road edges and human development, and often follow human trails or woods roads.



The overall track densities of I-89, River Road, and the transects are listed in Table 5 below. For all species combined, primary, secondary, and the most common focus species, the transects have substantially higher numbers of animal tracks than either I-89 or River Road. For all of these categories except coyotes and mink, River Road had higher numbers than I-89. Coyotes were relatively common on both roads, and foxes were common on River Road. The other species crossed both roads in relatively low numbers. In addition to those listed, smaller numbers of hare, cottontail, otter, raccoon, skunk, and weasel also crossed one or both roads and transects. Moose (3 sets of tracks) and bobcats (6 tracks) crossed transect lines but none of their track sets crossed roads.

**Table 5. Comparison of transect and road tracking results, per 400 feet per 90 days**

	Crossed Transect Line	Crossed River Road	Crossed I-89 (Both Barrels)
All Animals	278.7	118.2	15.1
Primary + Secondary	139.2	29.2	12.7
Primary Focus	95.0	13.8	7.5
Most Common Focus:			
Coyote	26.4	5.9	3.6
Fox	25.9	13.0	3.4
Deer	36.6	2.8	1.4
Mink	2.3	1.3	1.6
Fisher	27.9	3.8	0.7

The transect lines are believed to be fully permeable to wildlife, i.e., there are no known obstacles that impede their movement across the transect lines. Roadway traffic or roadside habitat may affect wildlife occurrence or movement as one approaches roads (either as an attractor or repellent), but compared to road crossing, transect crossing is relatively risk-free and permeability should still be relatively unimpeded. If the permeability of transects for wildlife movement is considered to be 100%, the amount of movement across River Road and I-89 can be expressed as a percentage of the movement across the transects, indicating the permeability of the roads relative to the transects (Table 6). Looked at this way, River Road and I-89 were 42% and 5% as permeable to all animals as transect lines, respectively. Considering only primary focus species, the relative permeability is 15% and 8%.

**Table 6. Comparison of transect and road permeability, assuming transect line represents 100% permeability**

	Crossed Transect Line	Crossed River Road	Crossed I-89 (Both Barrels)
All Animals	100%	42%	5%
Primary + Secondary	100%	21%	9%
Primary Focus	100%	15%	8%
Most Common Focus:			
Coyote	100%	22%	14%
Fox	100%	50%	13%
Deer	100%	8%	4%
Mink	100%	57%	70%
Fisher	100%	14%	3%

The density of tracks within each 400-foot road and transect segment is displayed graphically in Figures 33 through 40. Note that the unit ranges in Figure 33 (listed in the legend) are different from the ranges used in the other figures.

INTENTIONALLY BLANK

Figure 33. Track densities along I-89 and River Road segments - all species

Note: Track densities include partial road crossings, full road crossings, and crossings through culverts and bridges

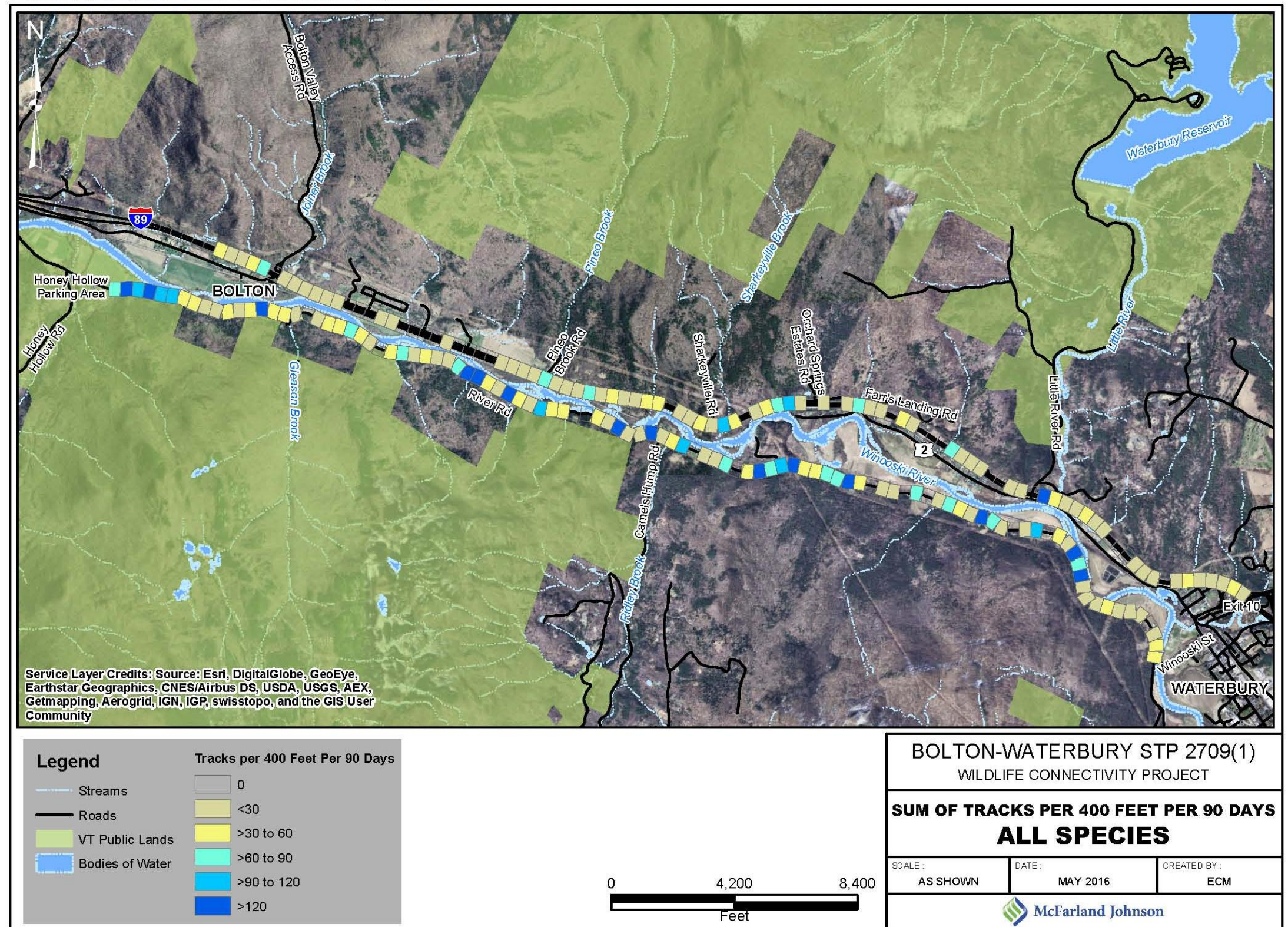

Figure 34. Track densities along I-89 and River Road segments – primary and secondary focus species

Note: Track densities include partial road crossings, full road crossings, and crossings through culverts and bridges

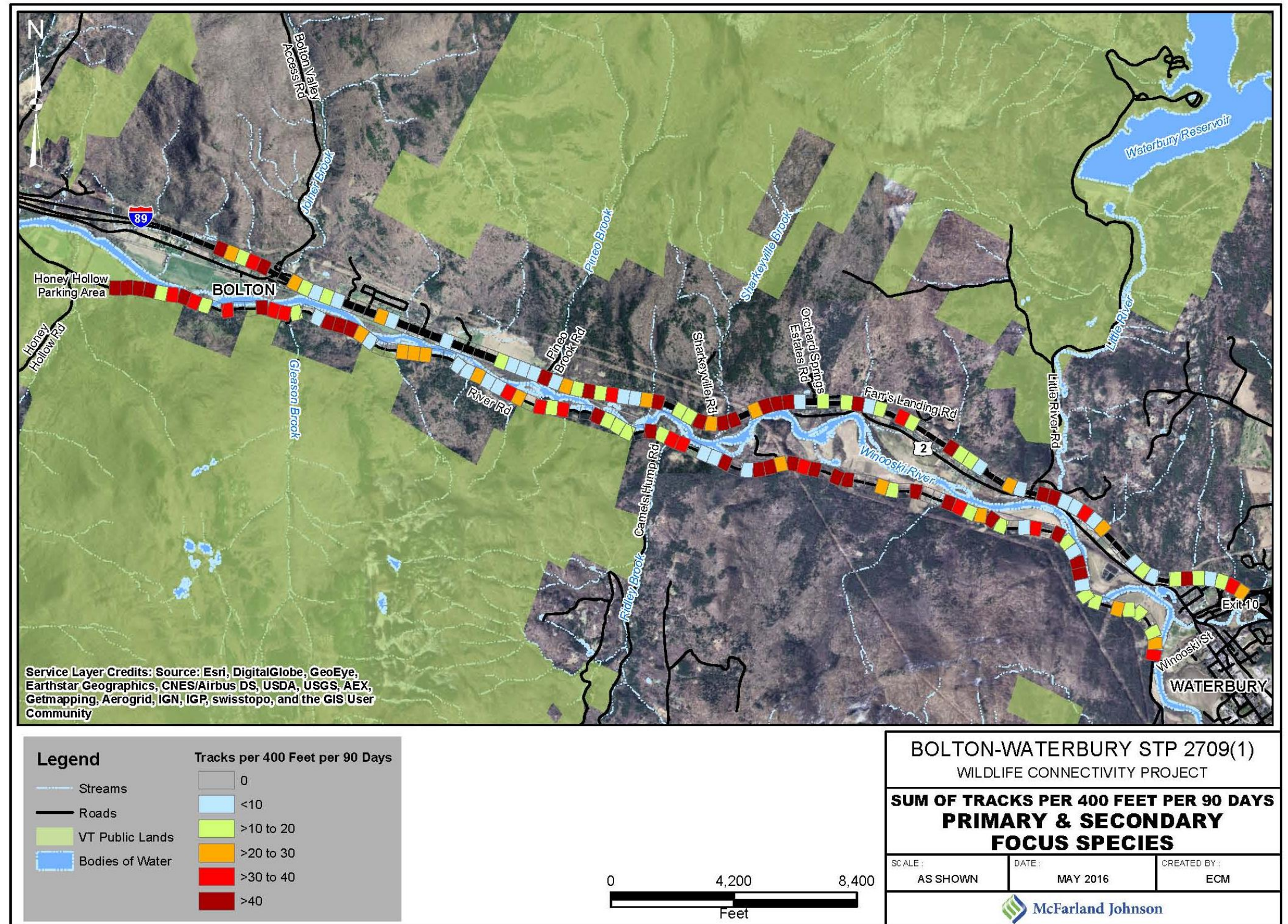

Figure 35. Track densities along I-89 and River Road segments – primary focus species

Note: Track densities include partial road crossings, full road crossings, and crossings through culverts and bridges

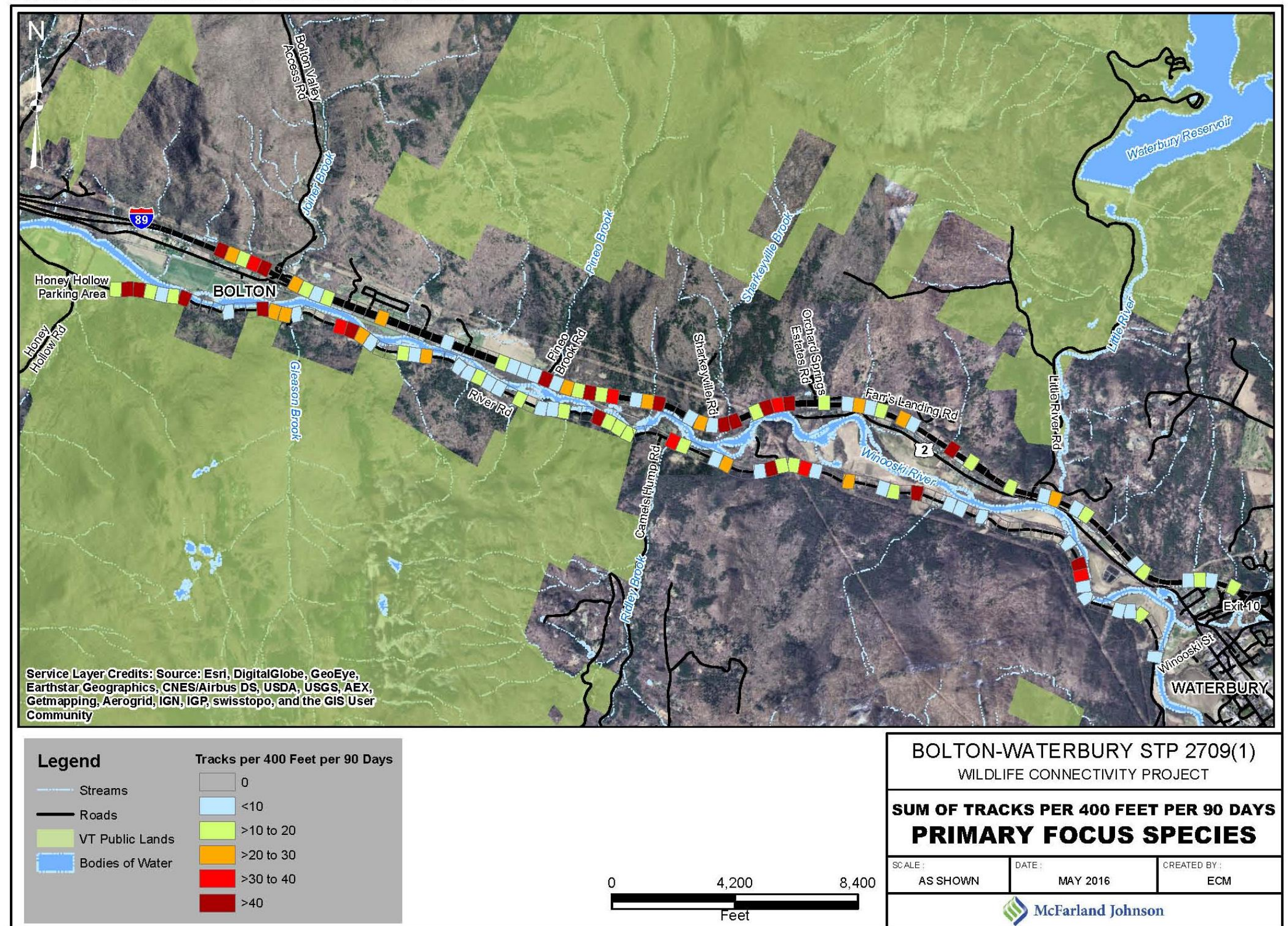

Figure 36. Track densities along I-89 and River Road segments – deer

Note: Track densities include partial road crossings, full road crossings, and crossings through culverts and bridges

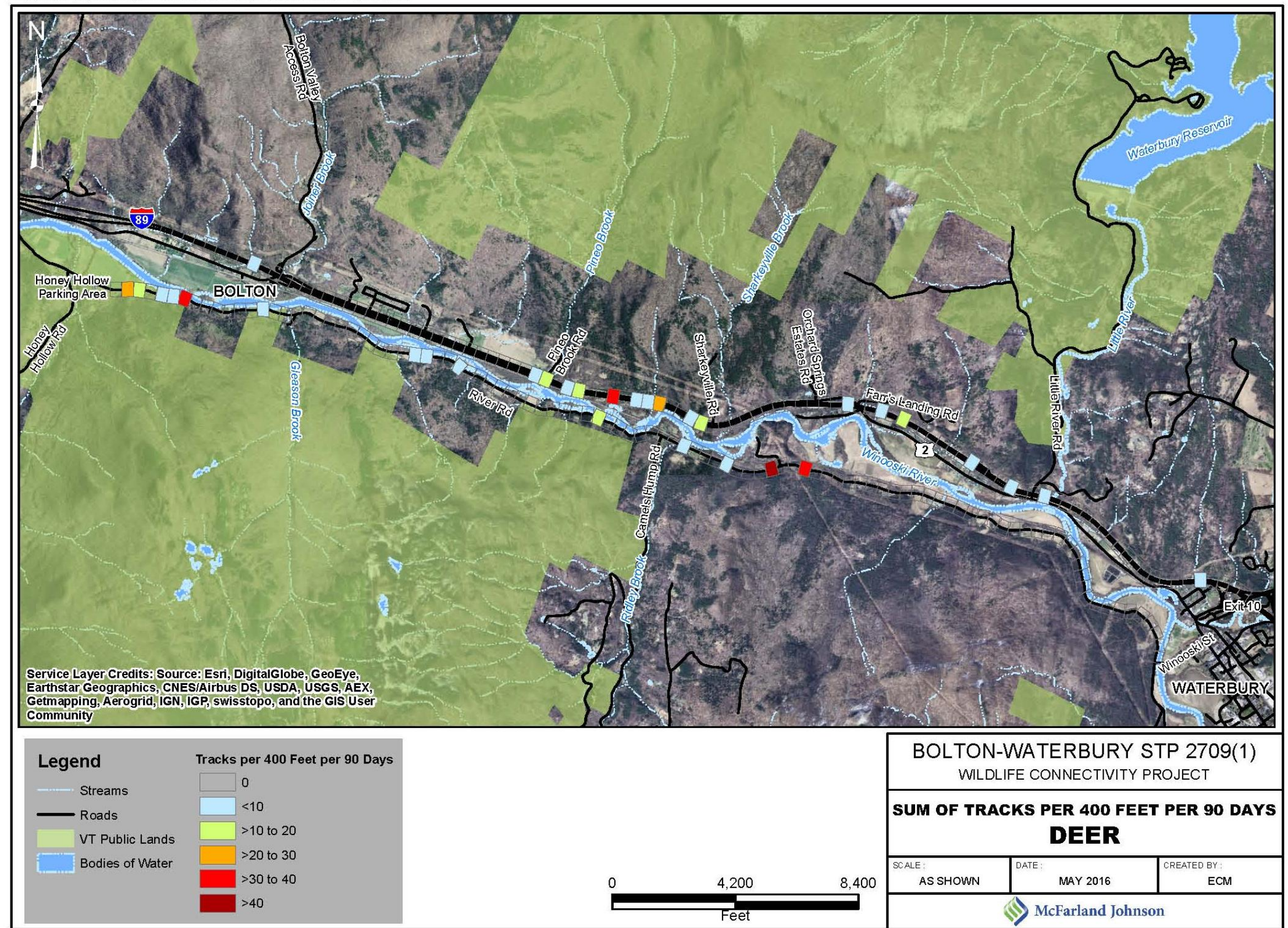

Figure 37. Track densities along I-89 and River Road segments – coyote

Note: Track densities include partial road crossings, full road crossings, and crossings through culverts and bridges

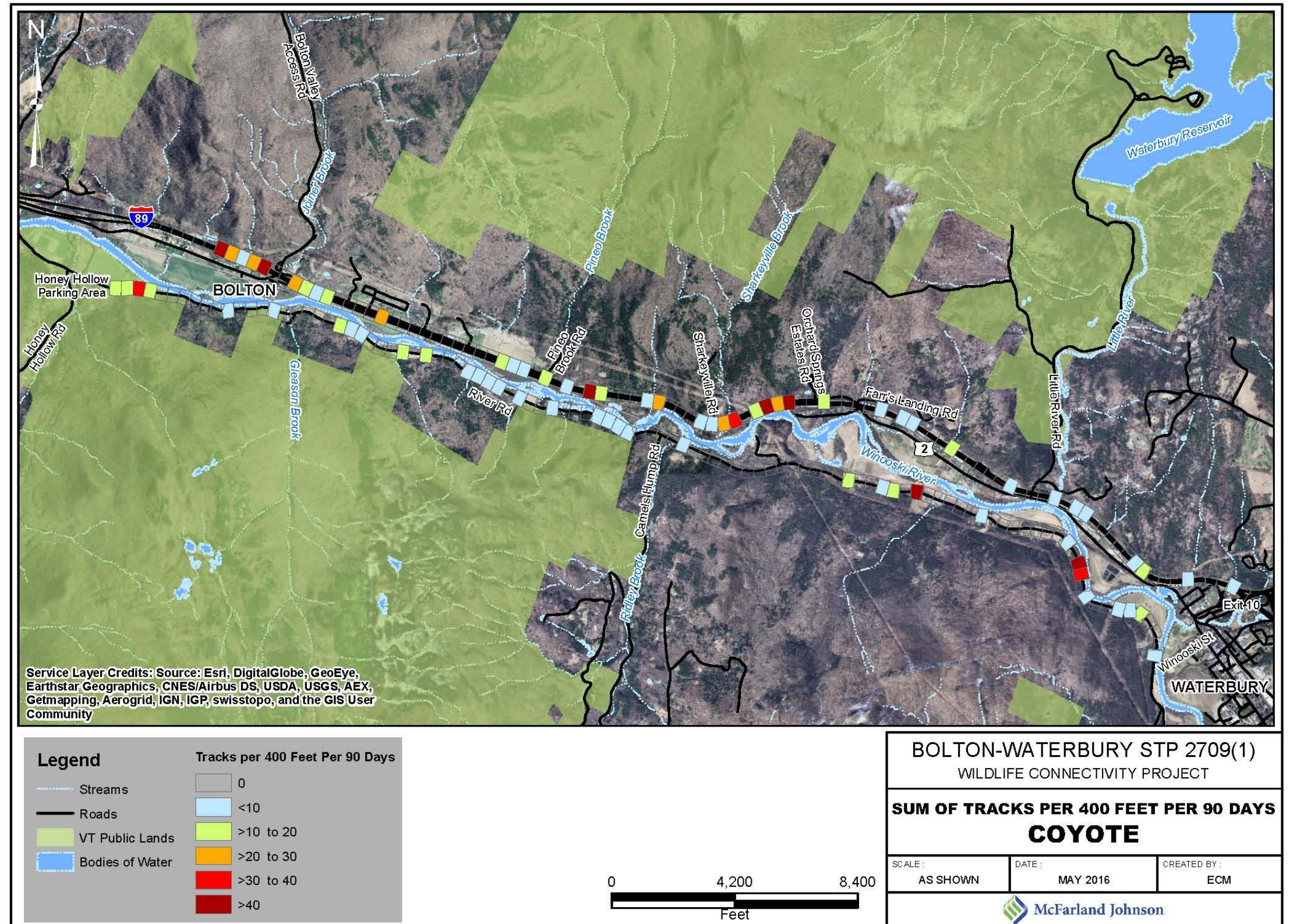



Figure 38. Track densities along I-89 and River Road segments – fox

Note: Track densities include partial road crossings, full road crossings, and crossings through culverts and bridges

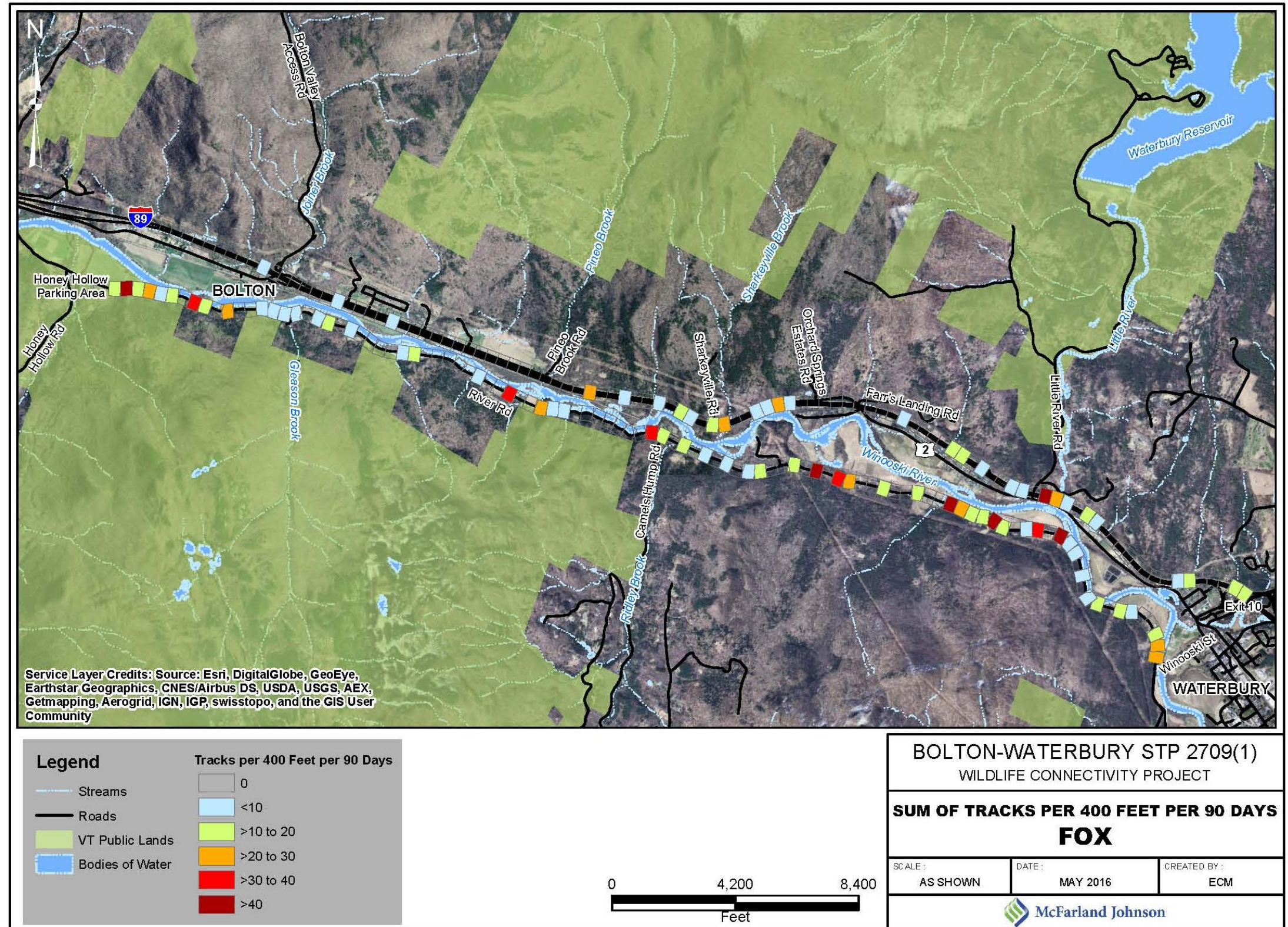

Figure 39. Track densities along I-89 and River Road segments – fisher

Note: Track densities include partial road crossings, full road crossings, and crossings through culverts and bridges

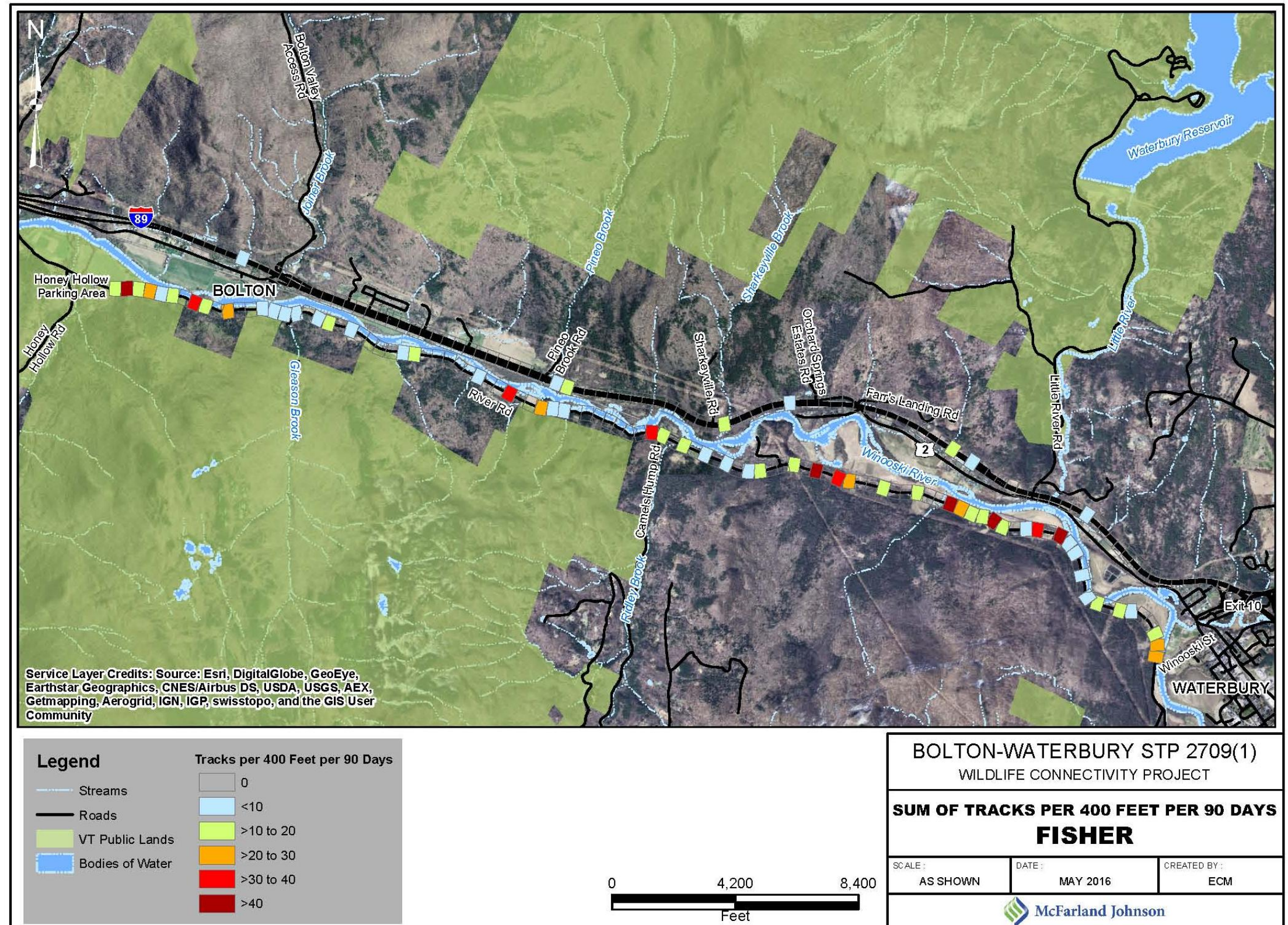
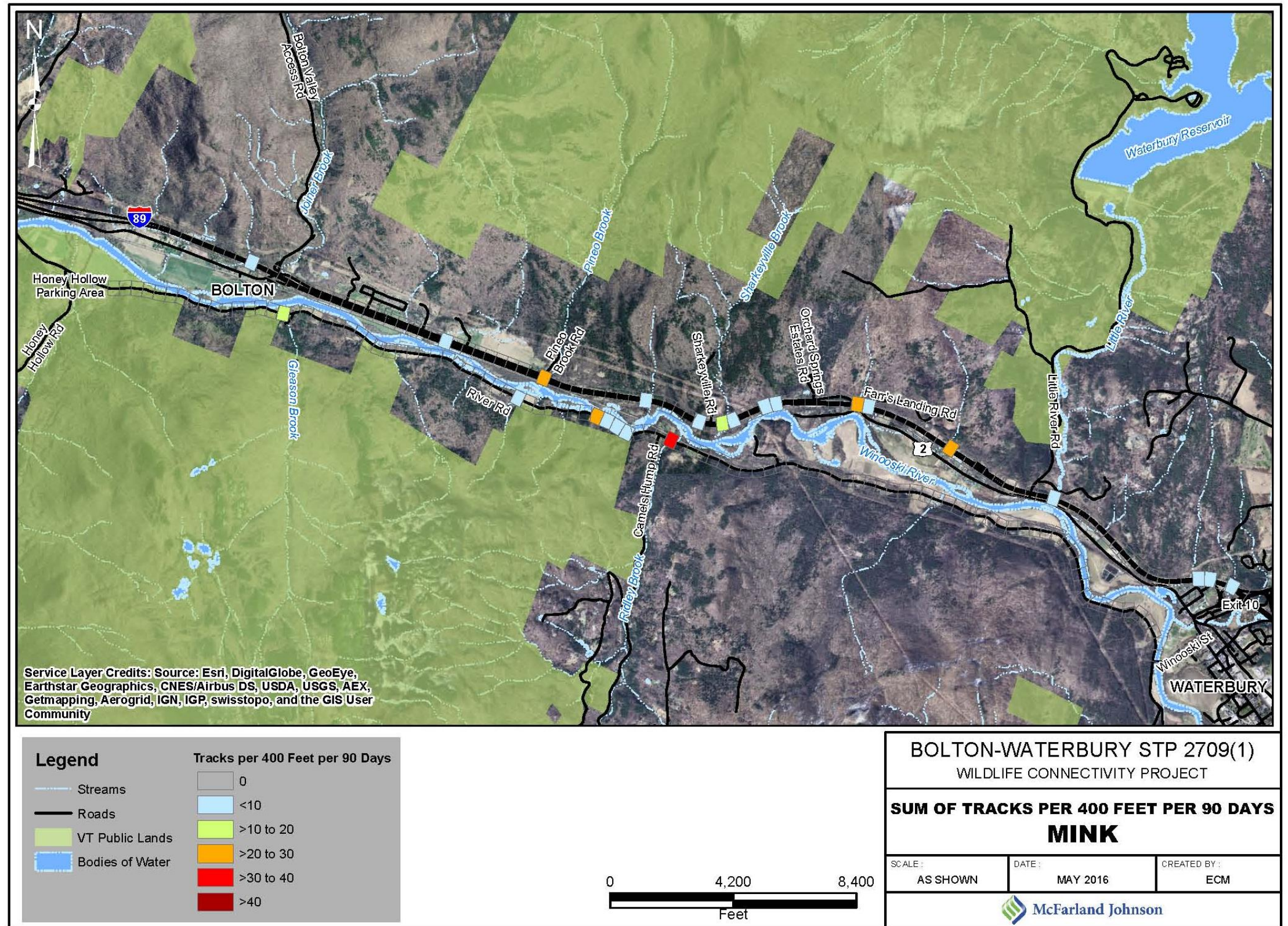

Figure 40. Track densities along I-89 and River Road segments – mink

Note: Track densities include partial road crossings, full road crossings, and crossings through culverts and bridges



### ***Track Density Along I-89 Segments***

These track density maps show substantial variation in the concentration of tracks along the corridor. Below is a detailed description of the tracking results along the entire length of the I-89 study corridor. Bridge and culvert usage is noted here but discussed in more detail in the report section following this one.

The west end of the corridor, west of Joiner Brook and Bolton Valley Road, was an area of high coyote activity. There were also single records of fox, deer, mink, and fisher, and a few unidentifiable tracks. All of these crossings were over the road surface. This area includes a ridge line north of I-89 and residential and farm fields along the south side. The north side of the highway has standard ROW fencing and the south side has chain link fencing.

Only 3 squirrel tracks and one unidentifiable track were found under the I-89 bridge over US Route 2 and Joiner Brook in Bolton Village, even though there appears to be ample room for wildlife movement (Photo 1). There are, however, a river, adjoining road, school, homes, and other potential barriers in this area.

#### **Photo 1. I-89 bridge over US 2 and Joiner Brook in Bolton Village**

*(Bolton Valley Road is on the right – Google Maps image)*



There were only a few tracks on I-89 between Bolton Valley Road (Joiner Brook) and Pineo Brook Road. There was no culvert usage in this segment. This entire segment has a chain link fence

between I-89 and US Route 2, as shown in Photos 2 and 3 below. Portions of the fence have fallen down or become overgrown with vegetation, but the fence is largely intact and may be a barrier to some species. There are anecdotal reports of the fence deterring animals from successfully crossing the roadway corridor.

**Photo 2. End of chain link fence and beginning of median Jersey barrier**

*(Facing west in the vicinity of Pineo Brook Road - Google Street View image)*



**Photo 3. Condition of chain link fence**

*(Between I-89 and US 2 between Pineo and Joiner Brooks – Google Maps image)*



From Pineo Brook Road and continuing east past Sharkeyville Road and the east end of the Jersey barriers roughly to Orchard Springs Estates, there were relatively high numbers of tracks, crossing both over the highway (55 animals) and through culverts (27 animals). The most common animals crossing over the road included coyote, deer, and fox, plus 3 fishers and 1 raccoon. The common animals using culverts included mink and fox, along with 3 raccoons and 2 each of coyote, weasel, and fisher. The effect of the Jersey barrier on animal movement is not known, though it may deter smaller animals from crossing. There is a possible divide at the sharp curve in the road, where there is a rock cut and a segment of chain link fence (see Figure 4 and Photos 4 and 5 below).

**Photo 4. Segment with Jersey barrier in median and rock cuts on both sides of I-89**

*(east of Pineo Brook - Bing Maps image)*

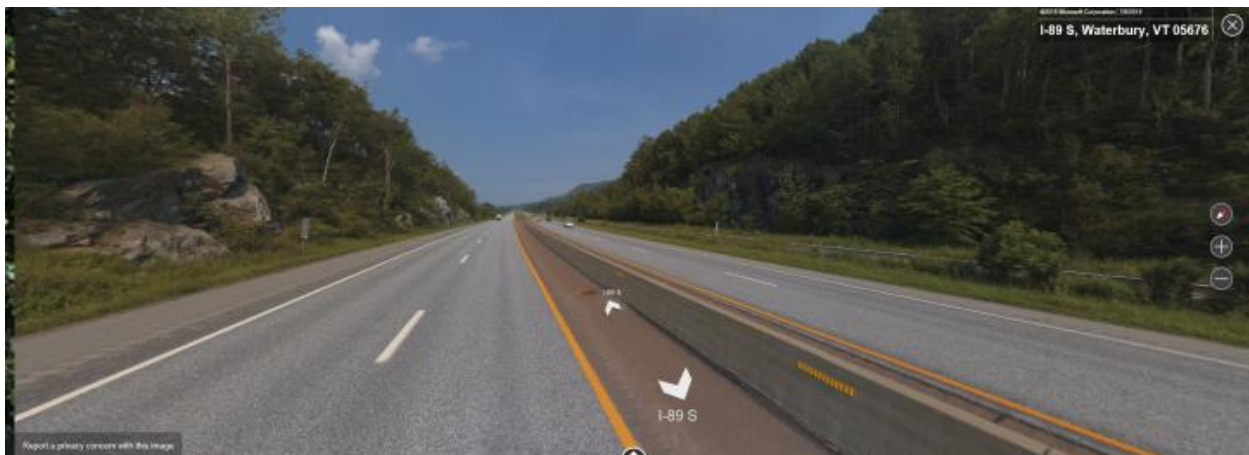

**Photo 5. Chain link fence meeting rock cut section**

*(Between Sharkeyville and Orchard Estates near MM 67.1 – Google Maps image)*



East of Orchard Springs Estates, continuing to Little River, was an area of scattered wildlife travel. In this segment, 66 animals crossed over the road surface, 18 via culvert, and 4 under the bridge over US Route 2 by Farr's Landing Road. The road crossings were mostly coyotes and foxes, plus 6 deer, 3 mink, 3 raccoon, 2 fisher, and 1 weasel. The culvert crossings included 7 mink, 2 each of fisher, fox, raccoon, and weasel, with 1 squirrel and several unidentifiable. Passing under the bridge were 2 skunks, 1 raccoon, and 1 squirrel. One segment has a rest area with two parallel chain link fences (Photo 6).

**Photo 6. Rest area with parallel chain link fences and smaller rock cut**

*(West of Little River – Google Maps image)*



Many animal tracks were observed under the I-89 bridge over Little River. A total of 22 tracks were seen, including 11 fox, 1 coyote, 1 mink, 1 otter, 1 squirrel, and 7 unidentifiable. An additional 4 unidentifiable tracks were found crossing I-89 over the road surface.

East of the Little River bridge to the Exit 10 ramps (Photo 7), animal tracks were spotty. Of 40 sets of tracks, 32 crossed over the road surface and 8 passed through culverts. Crossing over the road were 7 coyotes and lesser numbers of fox, weasel, hare, mink, deer, fisher, raccoon, and cottontail. Using culverts were 6 foxes and 2 raccoons.

**Photo 7. I-89 forested both sides to pavement edge with no obvious barriers**

*(East of Little River – Google Maps image)*



***Track Density Along the River Road Study Corridor***

River Road had a generally higher density of animal tracks than I-89. There are few obvious patterns along River Road, and most of the road appears to be highly permeable to wildlife movement. The two sections of River Road immediately west of the Camel’s Hump Boundary transect and the Logging Road transect both had relatively few animal tracks. These correspond to segments of I-89 with relatively low numbers of tracks. The primary focus species may be more concentrated on River Road near the middle and western sections of the road, which correspond to concentrations on I-89. However, the patterns are not distinct and it is difficult to draw any conclusions regarding links between findings on I-89 and River Road. Comparing the numbers of individual species on I-89 and River Road, there was more coyote traffic on I-89 and more fisher and fox activity on River Road.

**Photo 8. Typical segment of River Road (Duxbury Road) in study area**

*(Western portion of road – Bing Maps image)*

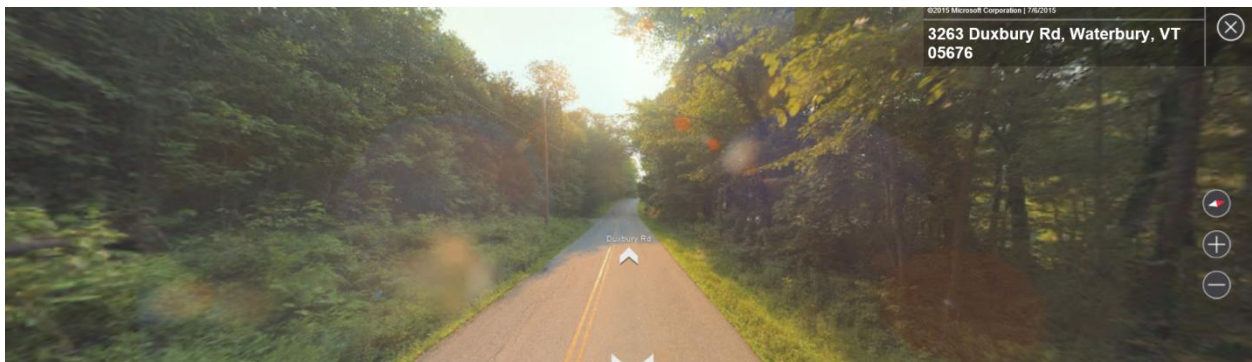



## Road Tracking Results: Culvert and Bridge Usage

Table 7 lists culverts and bridges under I-89 where tracks indicated usage by animals. The culvert type, size, and the actual numbers of tracks of each species observed are listed. All but one of the animals crossed under both barrels of I-89. Figures 41 through 44 show the culvert locations and species on an aerial photo base. Note that not all culverts were used. For example, the Joiner Brook structure is an approximately 32-foot wide bridge, but no crossings were observed within it – either during tracking or from trail cameras. Key findings included:

- The study corridor includes the following structures under I-89, based on VTrans databases:
  - Two bridges over US 2 and one bridge over Little River and a local road. The US 2 bridge over Joiner Brook is under one of these I-89 bridges.
  - Four large culverts ranging from 6 to 14 feet in width or diameter.
  - 182 small culverts, including 93 18-inch pipes, 55 24-inch pipes, 7 30-inch pipes, 17 36-inch pipes, 8 pipes ranging from 42 to 66 inches, and 2 pipes of unspecified size.
- The total length of all of these structures (longitudinally along I-89) is 1,175 feet: 352 feet of small culverts, 38 feet of large culverts, and 785 feet of bridges. It is not known how much of this length is suitable for animal passage. The total roadway length is approximately 38,808 feet.
- Under the three bridges, a total of 29 sets of tracks were observed over the course of tracking efforts, mostly foxes (11) and other unidentifiable canines (7). The Little River bridge had 22 track sets. The other 7 were at the two bridges over US Route 2.
- A total of 16 culverts were used, including 1 box culvert (Pineo Brook), 8 corrugated metal pipes (CMP), 6 reinforced concrete pipes (RCP), and one unspecified type.
- One box culvert was used 9 times, including 4 mink, 2 coyotes, 2 raccoons and 1 squirrel. This structure (Pineo Brook) is approximately 12 feet wide.
- The 8 corrugated metal pipes (CMP) were crossed 24 times, by fox (12), mink (5), fisher (2), raccoon (2), weasel (1), and 2 unknown animals. Pipe sizes ranged from 18 inches (with 1 fox) to 60 inches. The most frequently used CMP (9 animals) was Culvert 5, a 36-inch CMP located between Sharkeyville Road and the 60-inch Sharkeyville Stream CMP. At this location there is both forested and power line habitat to the north and a wide swath of forested land along the river to the south.
- The 6 reinforced concrete pipes (RCP) had 18 animal track sets: mink (6), weasel (3), fox (3), raccoon (3), fisher (2), and 1 unidentifiable. The most frequently used, with 6 tracks, was Culvert 13, a 42-inch structure along the straight segment of I-89 between Farr's Landing and Little River Road. There is a mixture of forest and old field habitat to the north and residential land and farm fields to the south.
- No deer were found using any of the structures during tracking efforts, although cameras recorded deer at the entrance to the Pineo Brook inlet and passing under the Little River bridge.

**Table 7. Numbers of tracks of each species found using structures under I-89 during winter**

*Note: Only those culverts with wildlife movement are listed; other culverts of similar size or type are present within the corridor.*

Structure or Culvert No.	Type	Size (in.)	Coyote	Fisher	Fox	Mink	Otter	Rac-coon	Skunk	Squir-rel	Un-known	Un-known Canine	Wea-sel	Grand Total
US 2/Bolton	BRIDGE	Bridge								3				3
1 (Pineo Brook)	BOX	144+-	2			4		2		1				9
2	CMP	36			3									3
3	RCP	48				1								1
4	RCP	48				1		1					2	4
5	CMP	36		2	4	2					1			9
6 (Sharkeyville)	CMP	60				1								1
7	RCP	24									1			1
8	CMP	36				2					1			3
9	CMP	36											1	1
US 2/middle	BRIDGE	Bridge						1	2	1				4
10	?	?				1				1				2
11/12	RCP	30						2						2
13	RCP	42		2	2	4							1	9
Little River	BRIDGE	Bridge	1		11	1	1			1		7		22
14	RCP	36			1									1
15	CMP	18			1									1
16	CMP	48			2			1						3
17	CMP	42			2			1						3
<b>Grand Total</b>			<b>3</b>	<b>4</b>	<b>26</b>	<b>17</b>	<b>1</b>	<b>8</b>	<b>2</b>	<b>7</b>	<b>3</b>	<b>7</b>	<b>4</b>	<b>82</b>

**Table 8. Numbers of tracks of each species found using structures under I-89 during winter, grouped by structure size**

*Note: Only those culverts with wildlife movement are listed; other culverts of similar size or type are present within the corridor.*

Structure or Culvert Size (inches of diameter or width)	Coyote	Fisher	Fox	Mink	Otter	Rac-coon	Skunk	Squir-rel	Un-known	Un-known Canine	Wea-sel	Grand Total	No. of Species
<b>18-30</b>			1			2			1			4	3
<b>36-60</b>		4	14	11		3			2		4	38	6
<b>?</b>				1				1				2	2
<b>144</b>	2			4		2		1				9	4
<b>Bridge</b>	1		11	1	1	1	2	5		7		29	8
<b>Grand Total</b>	3	4	26	17	1	8	2	7	3	7	4	82	11

Figure 41. Culverts and bridges used by wildlife (1)

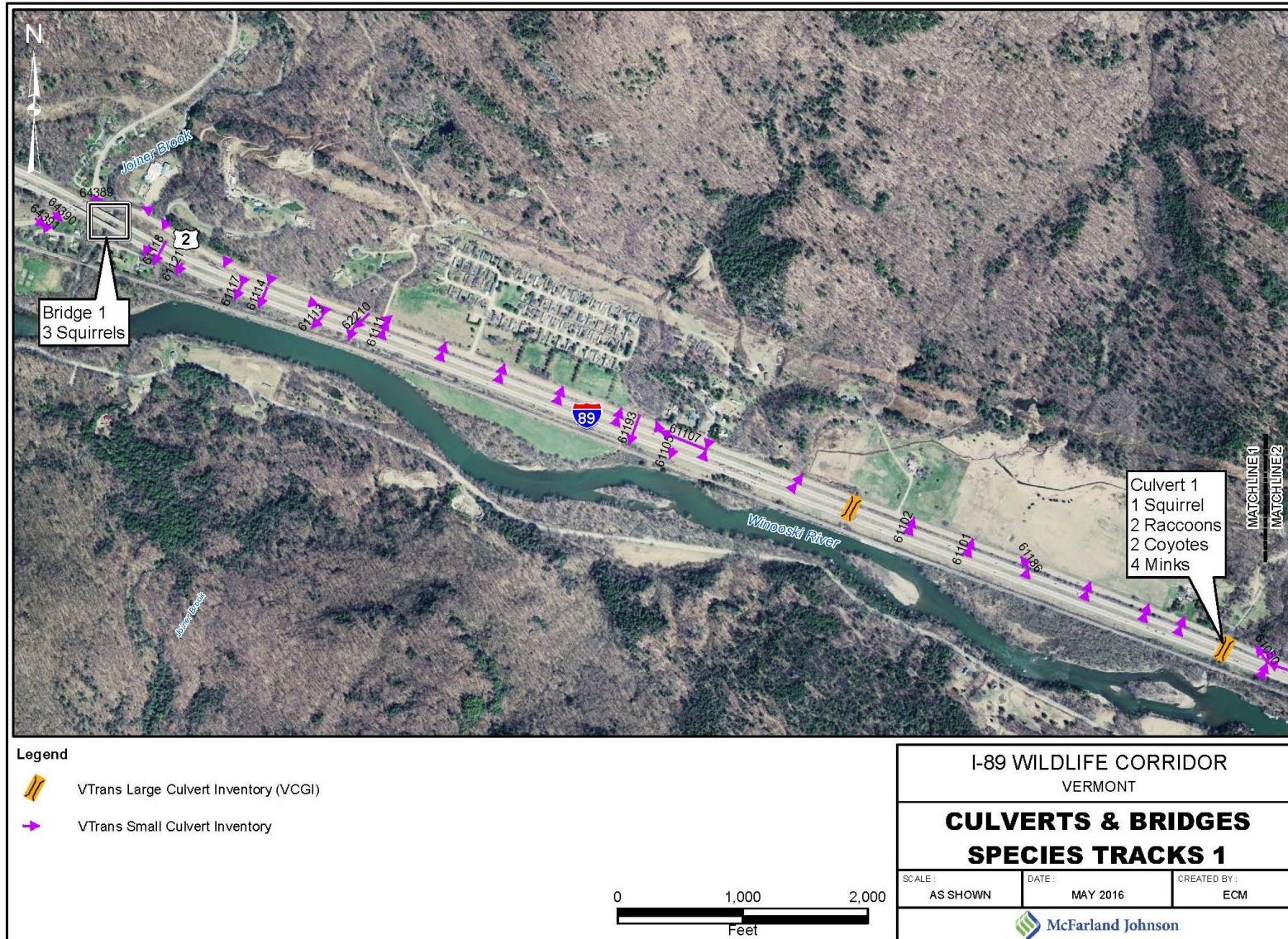

Figure 42. Culverts and bridges used by wildlife (2)

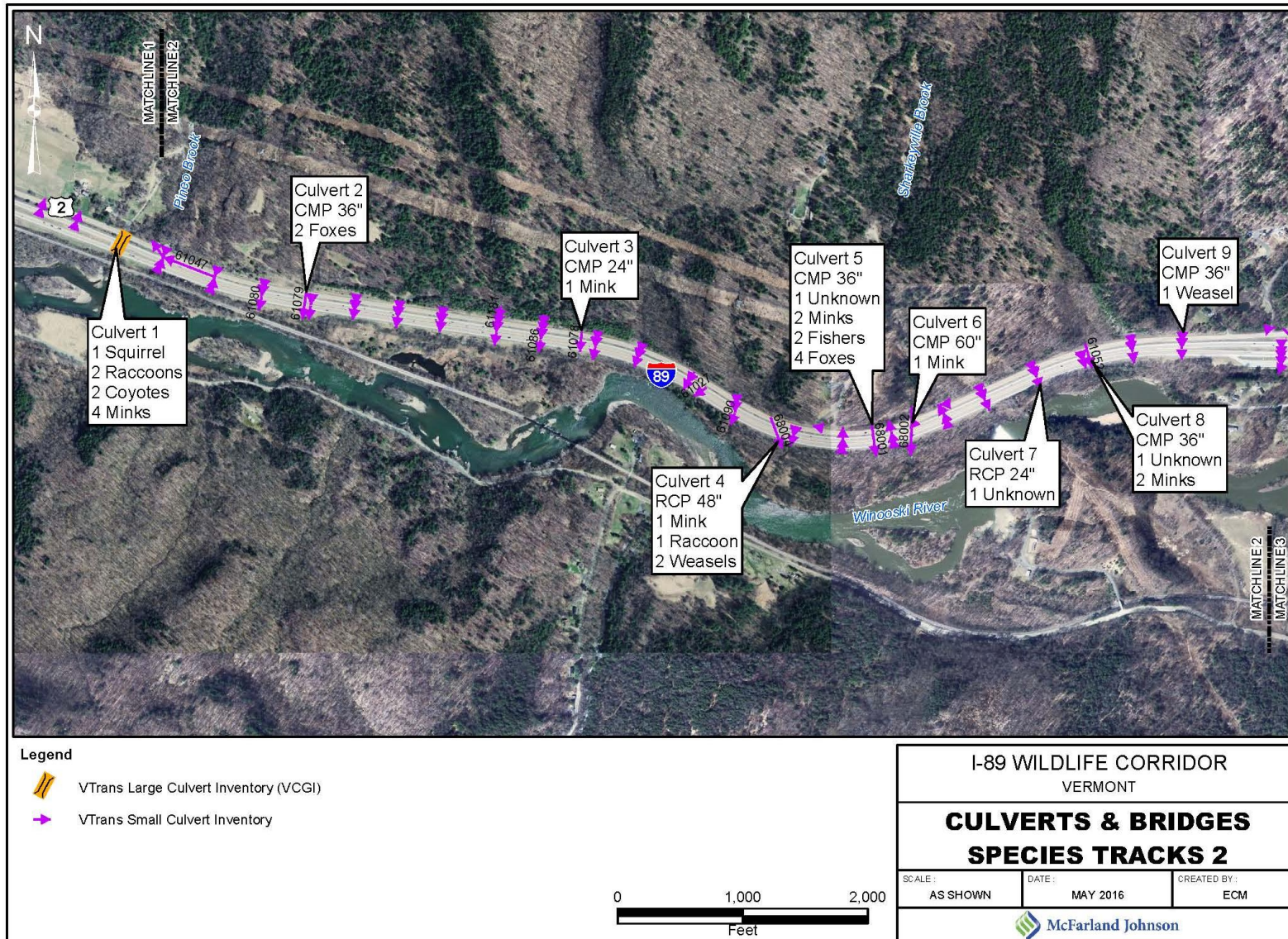

Figure 43. Culverts and bridges used by wildlife (3)

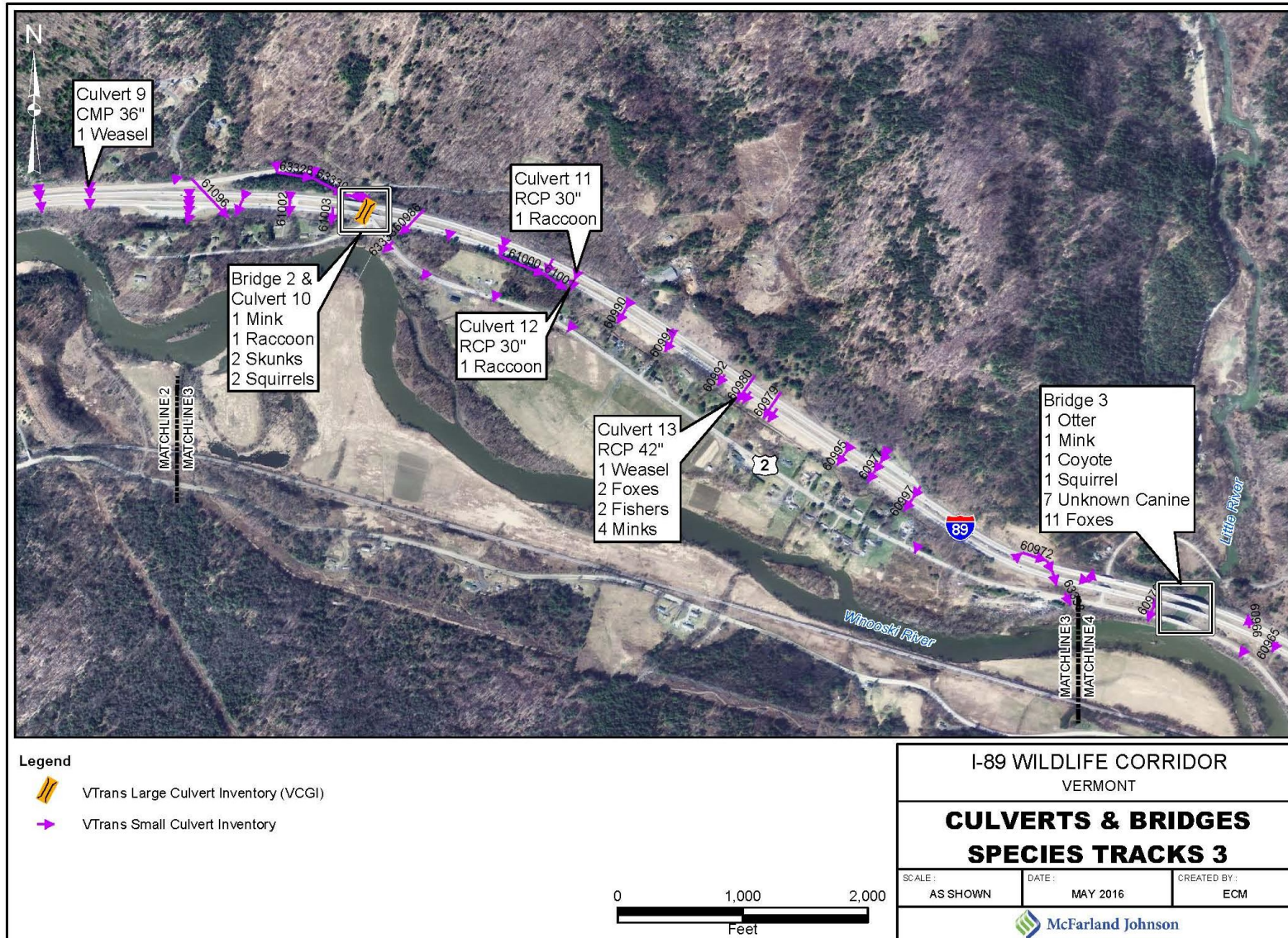
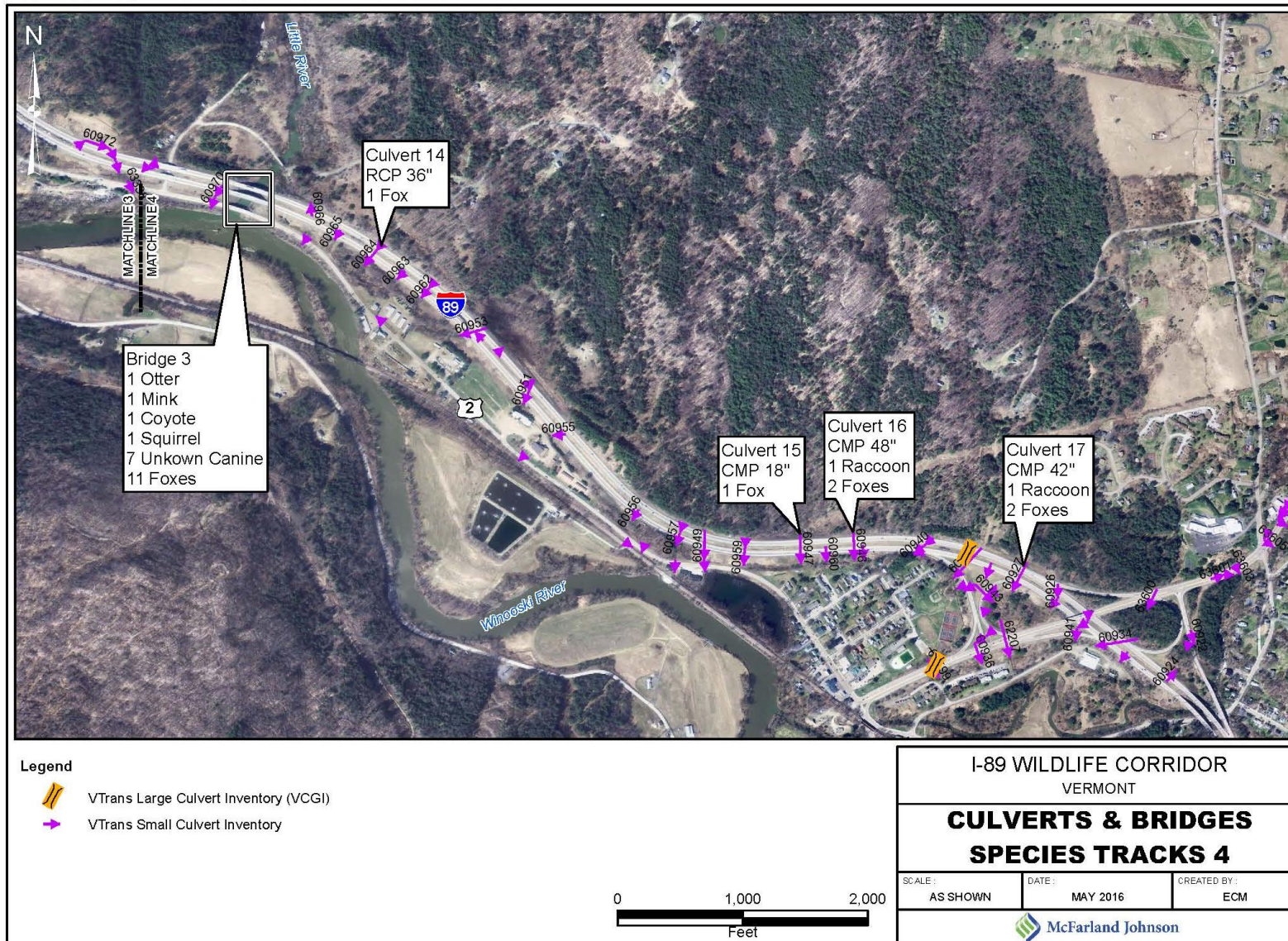

Figure 44. Culverts and bridges used by wildlife (4)



## **DISCUSSION**

### **Comparing Tracking and Camera Results**

In general the camera and tracking results correspond, but some differences were encountered: tracking results showed fewer bear and moose, more small mammals, and different spatial distributions of deer compared to camera results.

Black bears and moose were frequently photographed at camera stations. Black bears hibernate in winter and hence are absent from the tracking data. Only three sets of moose tracks were encountered during transect tracking, and none during road tracking. Moose, and probably other focus species to some degree, alter their habitats and movement patterns in the winter. The patterns seen in tracking results, therefore, do not represent the distribution of wildlife the remainder of the year. We know from roadkill data that bear and moose cross I-89, yet they are absent from winter tracking results. These are large animals that pose a greater danger to motorists and may have smaller populations that are more vulnerable to adverse effects of road mortality.

Compared to cameras, tracking recorded higher numbers of smaller mammals such as mink, fisher, and rabbit. Since some of these tracks were found within the reported range of the cameras, it is believed that the cameras are triggered by the presence of smaller animals as well as by larger animals. Therefore, smaller animals are likely underrepresented in the camera results.

Cameras showed more deer near the roadways (Near cameras), while winter transect tracking encountered more deer at the more distant portions of the transects. To determine whether the deer have a different winter distribution that would explain this result, the camera data were analyzed by month (Figure 45).

As shown in the figure, there are more deer at the Near cameras (compared to the Far and Remote cameras) all year round, including winter, when tracking found more deer further from the roads. It is possible that either the transect or camera results reflect pockets of deer activity that skew the results. It is a reminder that the study, while covering a broad area, relies on specific locations – camera stations, roads, and transects – for the data, and does not necessarily yield results that can be extrapolated to the entire study area.



**Figure 45. Numbers of deer photographed by month of year and corridor location**

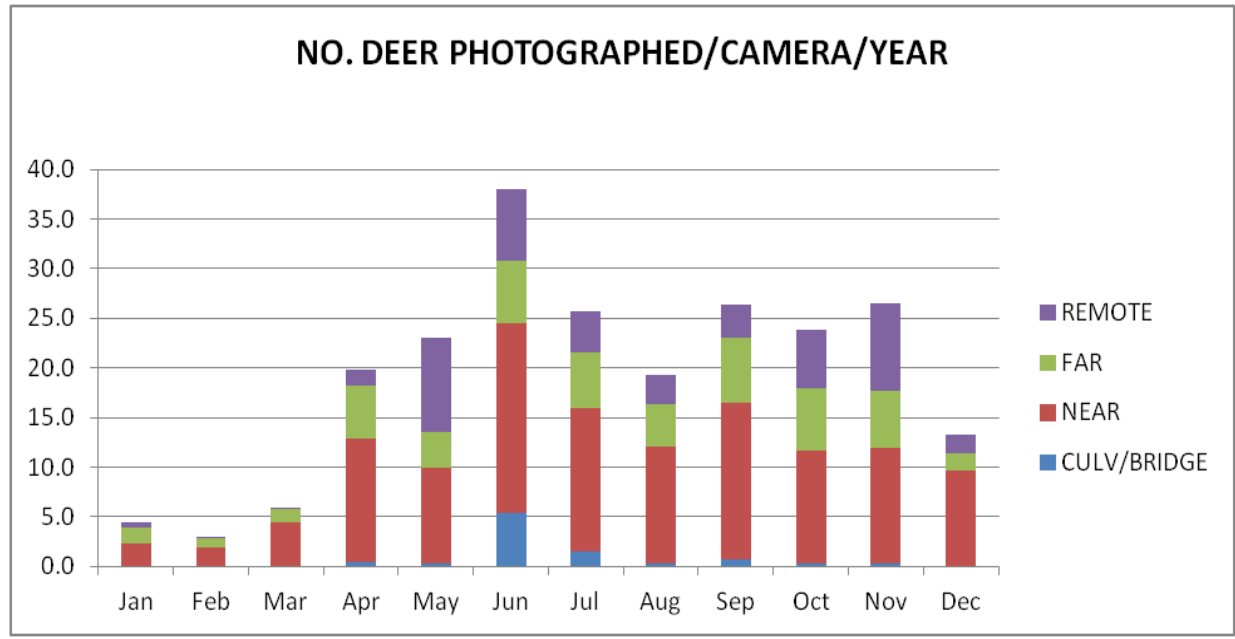

## Study Questions

This study was intended to address several specific questions regarding the interaction of wildlife with the I-89 corridor through the Green Mountains. Those questions, and responses based on our findings, are discussed below.

### 1. Is the habitat in the vicinity of the I-89 corridor where it bisects the Green Mountains rich in wildlife?

The purpose of this question is to determine whether the wildlife found in other parts of the Green Mountains and Vermont are also found in proximity to the highway corridor; in other words, whether there are existing populations that could be affected by the road and could benefit from roadway infrastructure modifications.

Both trail cameras and winter tracking showed that many different wide-ranging, medium- and large-sized mammal species occur throughout the corridor. Most focus species were found on both the north and south sides of the corridor, from the eastern to the western end, and in both forest edge and forest interior locations. The only primary focus species that were not widely distributed in the study area were bobcats and river otters. Bobcats have sparse populations with large ranges, yet were found in four locations on the north side of the corridor. This may be a function of their reported preference for south-facing slopes (Sue

Morse, pers. com.). Otters also have large ranges and sparse populations. They probably move up and down the Winooski River and some of its tributaries and even overland on occasion, but they were not detected by the trail cameras. Only one camera was aimed directly at the river and that camera only detected animals near one shoreline.

We conclude that most of the primary and secondary focus species are relatively common and widespread within the habitats on either side of the I-89 corridor.

## **2. Is there an edge effect along the I-89 corridor?**

Trail cameras showed more individuals of all primary focus species other than deer further from the roads. Deer were most abundant between 400 and 800 feet from the road edge.

Transect tracking, based only on winter animal movements, did not show a clear edge effect. Overall there were fewer tracks within the first 400 feet of the road edge, but this varied by species. Some species, such as fisher, were much less common within 400 feet of the road edge, possibly indicating an aversion to the road edge. Many species were most abundant between 400 and 800 feet of the road edge, though the reasons are unclear.

Taken together, the trail camera and tracking results show the distribution of most species changes with distance from the road edge, so it is concluded there is an edge effect. Most focus species appear to be repelled by the road corridor, but others, such as deer and fox, may be attracted to the forest edge habitat or the open-canopy habitat between the road and forest.

## **3. Is the I-89/Route 2 corridor currently a fragmenting feature?**

The transects provide a baseline showing what animal movements are like in the nearby forest matrix, where there are essentially no barriers to movement. In terms of primary and secondary focus species, the numbers of animals crossing I-89 and River Road were 13% and 21%, respectively, of the numbers observed crossing the transects. (The I-89 figures include culvert and bridge crossings along with partial crossings.) This suggests that these roads inhibit or deter animal movements, and that larger roads such as I-89 have a greater inhibitory effect than smaller roads.

In short, the roads were found to inhibit animal movement, and therefore can be said to fragment wildlife populations in the area. The degree of fragmentation appears to vary with the species and other factors such as the presence of natural and man-made barriers. Some alert, fast, and intelligent species such as the coyote cross over one section of I-89 regularly. Other species take advantage of culverts and other species rarely cross. Chain-link fence, Jersey barriers, rock cuts, and other features probably affect the ability or willingness of animals to cross the road corridor in some places.

#### **4. Is wildlife road mortality currently occurring?**

Existing moose and bear roadkill data are shown on Figure 3. Caution should be used in interpreting this data, as the locations may not be accurate, not all records represent roadkill, and some records could be duplicated. Nevertheless, they show a much higher concentration of dead moose records in the eastern half of the study area, and few records of either moose or bear in the chain link fence section to the west.

An effort to systematically gather roadkill data for this project was attempted but was not productive in terms of time spent and information gathered, so the effort was discontinued.

During winter tracking, 8 road-killed animals were encountered along I-89. These included 4 deer, 1 mink, 1 raccoon, 1 cottontail, and 1 unidentifiable species. No road-killed animals were encountered along River Road.

Based on these records, it is clear that wildlife mortality continues along I-89. It is not possible at this time to draw conclusions regarding the scale of the problem or the effects on wildlife populations from this study.

#### **5. Are existing culverts and bridges facilitating wildlife movement?**

Winter tracking showed that about one-fifth of animals entering the I-89 roadway passed through culverts and another 10 percent passed under bridges. Measured along the roadway, these structures only make up a fraction of the total road segment length available for crossing, so compared to the available roadway they were heavily used. It is apparent that these structures are important travel corridors for wildlife, and could probably be even more frequently utilized with modifications designed to accommodate wildlife movement.

In this study, some species used culverts as small as 18 inches, and some culverts had frequent wildlife usage while others of similar size were not used during the study's tracking rounds. The most frequently used structures included:

- Pineo Brook: 9 track sets. This is an approximately 12-foot wide box culvert with a shallow perennial stream and a concrete substrate. There were 9 sets of animal tracks in winter, although cameras showed deer approaching the inlet several times but never passing through it.
- A 36-inch dry storm drainage CMP near Sharkeyville Road: 9 track sets
- A 42-inch RCP west of Little River: 9 track sets
- The Little River bridge: 22 track sets

Several other structures carried 3 or 4 sets of tracks, including two bridges, two 36-inch CMPs, a 48-inch CMP, and a 48-inch RCP.

Both trail cameras and winter tracking revealed wildlife use of the Little River bridge, despite the relatively small amount of terrestrial habitat south of the bridge. The recently constructed shelf on the west side of this bridge was the most common wildlife travel route there; the east side of the bridge, with a steep rocky slope and road, was little used by wildlife.

Tracking showed relatively little use of the two bridges over US Route 2. The Joiner Brook structure, an approximately 32-foot wide bridge under US Route 2, also had no animal tracks and no trail camera photos of wildlife. The Sharkeyville Stream inlet, a 60-inch CMP, had one set of mink tracks and no wildlife photos.

In short, some structures are frequently used and facilitate wildlife movement, while other structures, including bridges, do little to facilitate movement.

#### **6. Would infrastructure modifications improve wildlife movements across barriers?**

There are presumably certain features which make some culverts or bridges hospitable and others inhospitable for animal travel. For example, the wildlife shelf under the Little River bridge is clearly a success, while the bridge over Joiner Brook is not conducive to wildlife movement (though possibly because of the adjacent land use rather than the structure itself). These features should be investigated, and the information used to guide future structure placement and design. The likelihood of the structure to be utilized by wildlife should be considered in planning roadway infrastructure improvements. For example, the Sharkeyville area had high numbers of wildlife and some culvert usage, so infrastructure improvements would have a high likelihood of success. The Joiner Brook bridge area saw less activity despite its relatively large openings, and may not be a good candidate due to the surrounding land use (multiple roads, school, etc.).

A number of other structures may impede animal movement across the corridor. Chain-link fencing, woven wire fencing, Jersey barriers, and steep embankments may deter certain species from crossing roads. The potential impact to wildlife movement should be evaluated and weighed against the other benefits provided by these structures. For example, chain-link fence is impermeable to most medium and large-size wildlife species, and could result in animals spending more time on the road, increasing the chances of wildlife-vehicle collisions. This risk could be compared with the fence's benefits, such as the ability to deter humans from the roadway.

## **Importance of I-89 Segments to Connectivity**

Ultimately it would be desirable to identify and prioritize segments of I-89 that are important for wildlife crossing, and that could be targeted for infrastructure improvements to facilitate wildlife crossing. There is presumably some set of landscape conditions, habitat characteristics, and structure design features that would better facilitate animal passage and improve habitat connectivity. It is not possible based on this study to identify and rank all possible variables and draw firm conclusions regarding wildlife crossing structure types, sizes, or locations.

There are certain areas within this corridor where higher numbers of wildlife are found, either crossing the roads or adjacent to the roads, and other areas where there is little wildlife activity. The habitat adjacent to the roads and both natural and man-made barriers clearly play a role in determining areas of concentrated crossing. All of these factors should be considered in evaluating locations for new or improved wildlife crossing infrastructure.

Below is an evaluation of the relative wildlife crossing value of each segment of I-89 within the study area. The intent is to identify areas with the greatest potential to improve connectivity between habitats and wildlife populations on both sides of the roadway corridor. The evaluation takes into account the camera and tracking results, existing landscape conditions along the corridor, and existing barriers to wildlife movement. Each segment of the study area is summarized below and the rankings are illustrated in Figure 46.

### West of Bolton Valley Road: Medium Priority

There was high wildlife crossing over the road here, but it was mostly coyotes, and there is extensive residential land use south of the road. However, the Joiner Brook transect, on the north side of the highway, had relatively high numbers of wildlife, so the area could be important for wildlife movements. Therefore, this segment is considered medium priority in terms of its potential for improving connectivity.

### Bolton Valley Road/Joiner Brook Area: Low Priority

This is a complex vehicular intersection with US Route 2 crossing under I-89, Bolton Valley Road branching off, and Joiner Brook passing under both US Route 2 and I-89. On the north side of I-89 and US Route 2, there is a school on the east side of the stream and Bolton Valley Road on the west side, both of which may inhibit wildlife movement. There are already structures (the US Route 2 and I-89 bridges over Joiner Brook) that are large enough to accommodate wildlife movements, but little wildlife activity was found in this area. It is possible that habitat modifications adjacent to the roads, school, and other development, could improve wildlife movement. Overall, this area is considered low priority.

#### Bolton Valley Road to Pineo Brook Road: Medium Priority

This segment of road had little wildlife crossing activity, although local residents report wildlife making it across this section of I-89 only to be turned back by the fence. US Route 2 closely parallels I-89, creating essentially a three-barrel roadway; a chain link fence separates the two roads and presents an impediment to wildlife movement along this entire segment; the north side of the road has a mixture of farm fields and mowed lawns; and the south side has minimal amounts of terrestrial habitat between the roads and the Winooski River. Nevertheless, this is a long segment and ideally there should be some wildlife passage potential. The costs, benefits, and impacts of the chain link fence should be reevaluated. This segment is considered medium priority.

#### Pineo Brook to I-89 over US Route 2 Bridge: High Priority

This segment includes Pineo Brook, a rock cut, the Sharkeyville residential area, Sharkeyville Stream, and a power line. The Pineo Brook and Sharkeyville crossings are discussed individually below. Winter tracking revealed several concentrations of wildlife crossings across I-89 along this segment, both over the road surface and through culverts. Additionally, there are multiple records of past moose and bear roadkill. Mt. Mansfield State Forest is less than one mile north of this segment, and Camel's Hump State Park is close to River Road to the south. This is a high priority segment for wildlife connectivity.

#### Pineo Brook Culvert: High Priority

There were relatively high numbers of road crossings in this area and some usage of the culvert. As an existing perennial stream corridor with a relatively large structure, this crossing has high potential wildlife crossing value. Mt. Mansfield State Forest is less than one mile north of the crossing, and Camel's Hump State Park abuts River Road directly to the south. For these reasons, this structure is considered high priority for wildlife connectivity.

#### Sharkeyville Area: High Priority

Trail cameras revealed a very high concentration of deer, along with photos of moose, coyote, and bear in the vicinity of Sharkeyville Road and Stream. Winter tracking revealed that coyote, fox, fisher, mink, and weasel cross over or under the highway in this area. There was little use of the Sharkeyville Stream culvert, but a 36-inch dry storm drainage culvert was used by three species. This appears to be an area of potentially high importance for wildlife connectivity.

#### US Route 2 Bridge to Little River Road: Medium Priority

This segment had a moderate number of wildlife crossings and little use of culverts. There are no perennial stream culverts. However, there is abundant undeveloped forested habitat along the north side of I-89 and south of River Road. Approaching Little River, there is conservation land (Little River State Park, part of Mt. Mansfield State Forest) less than one-half mile north of I-89, but south of River Road, conservation land is over one mile away. Overall, this area is medium priority for improving wildlife connectivity.

#### Little River Bridge: Medium Priority

Although there is a limited amount of terrestrial habitat south of the bridge, tracking and cameras showed many animals passing under the bridge. Tracking and cameras also showed that the Little River corridor upstream of the bridge had relatively high numbers of wildlife. This is an important wildlife habitat area and wildlife travel corridor, and the bridge links that habitat to the Winooski River riparian corridor. Because it already facilitates wildlife crossing, it is designated a medium priority crossing from a connectivity perspective.

#### Little River Bridge East to I-89 Exit 10: Medium Priority

East of the Little River bridge to Exit 10, tracking showed relatively light amounts of wildlife travel over the road and through culverts. North of I-89 is a mixture of forest and residential land use; between I-89 and the Winooski River are commercial development and a wastewater treatment plant; and south of River Road is extensive forest land. The fragmented landscape along this segment suggests this is a medium priority crossing area.

Figure 46. Relative wildlife crossing value of road segments

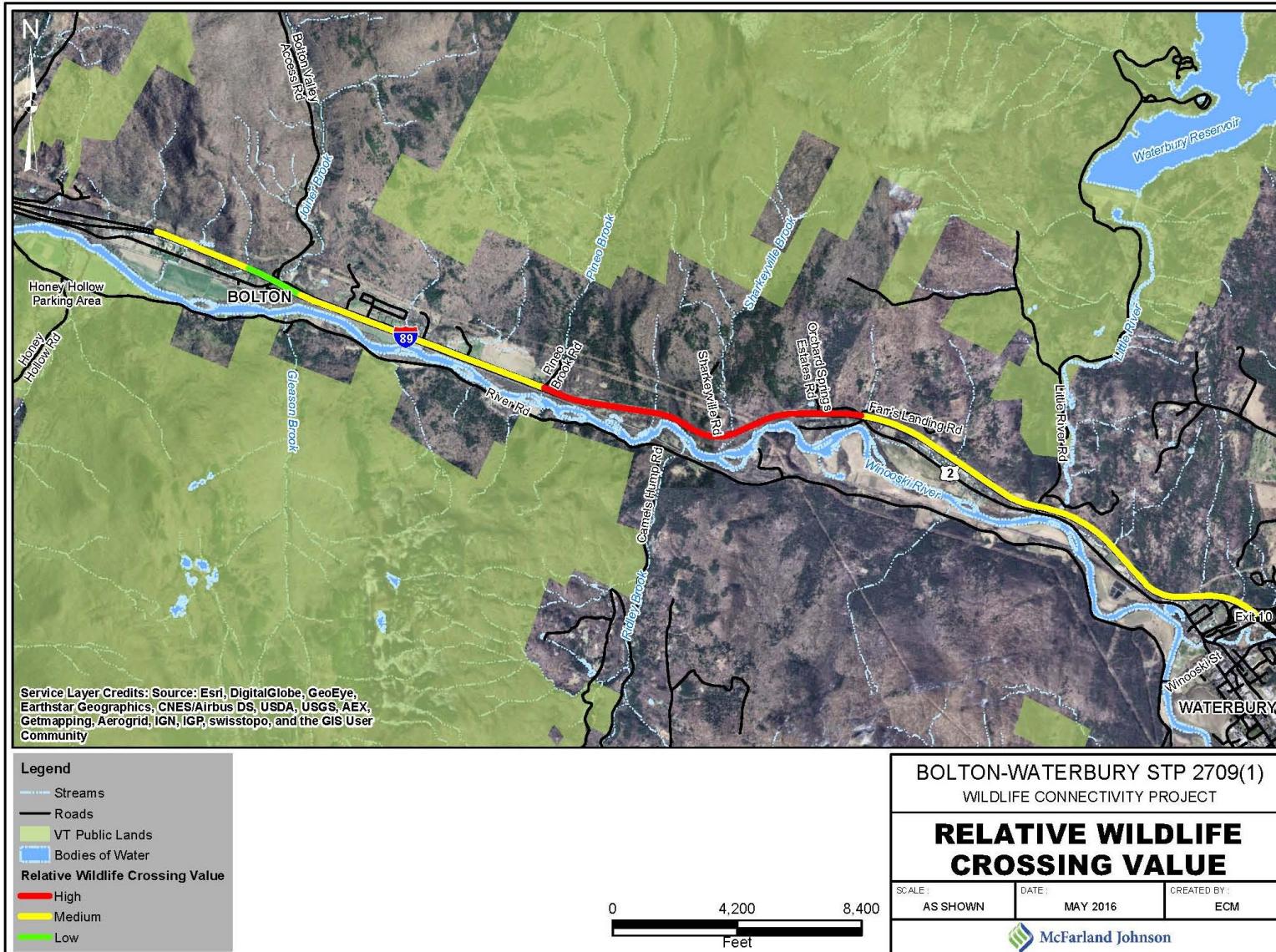





**Bolton Waterbury STP 2709(1)**

**Wildlife Connectivity Study**

**Appendix A**

**PHOTO LOG**



# PHOTO LOG

## Contents

I-89 WITHIN STUDY AREA ..... 2

RIVER ROAD WITHIN STUDY AREA..... 3

LARGER STRUCTURES WITHIN STUDY AREA ..... 4

CAMERA HARDWARE AND DEPLOYMENT AT LITTLE RIVER BRIDGE ..... 7

SELETEDED WILDLIFE PHOTOGRAPHS..... 9

1960 PHOTOGRAPHS OF CORRIDOR..... 11

## I-89 WITHIN STUDY AREA

Eastern portion of I-89, west of Exit 10, facing west (Bing Maps image)



I-89 east of Sharkeyville, showing median barrier and rock cut, facing west (Bing Maps image)

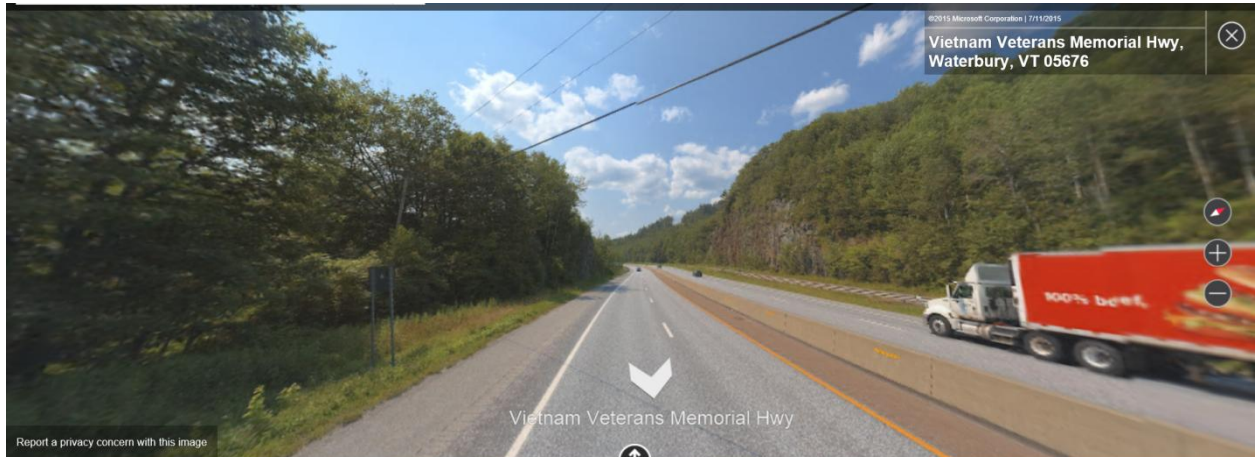

I-89 in western portion of study area, facing west (Bing Maps image)

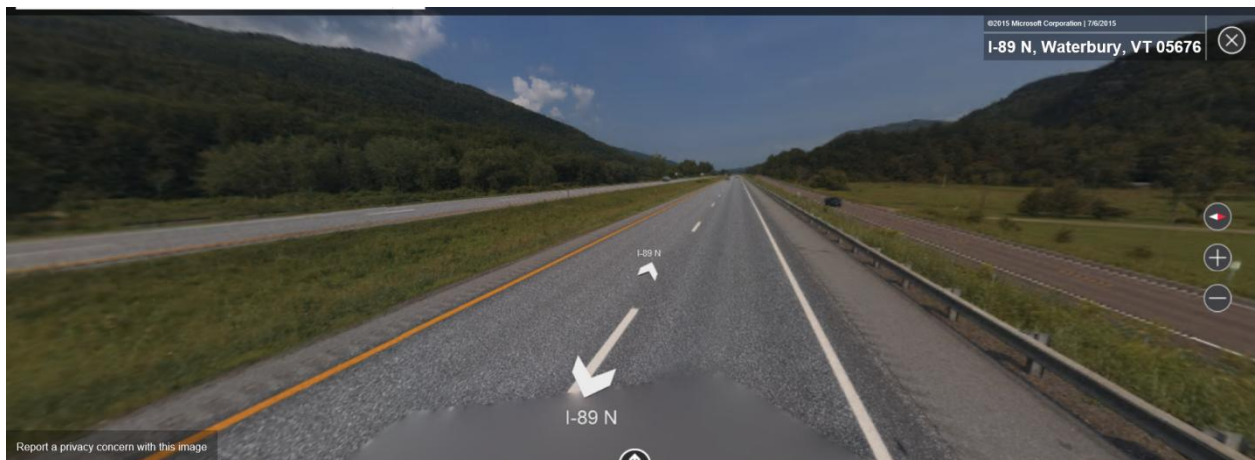

## RIVER ROAD WITHIN STUDY AREA

Eastern portion of River Road, a mixture of farm fields and forest (Google Maps image)



Western portion of River Road (Duxbury Road), forested on both sides, no shoulders, nearly closed canopy in places (Bing Maps image)

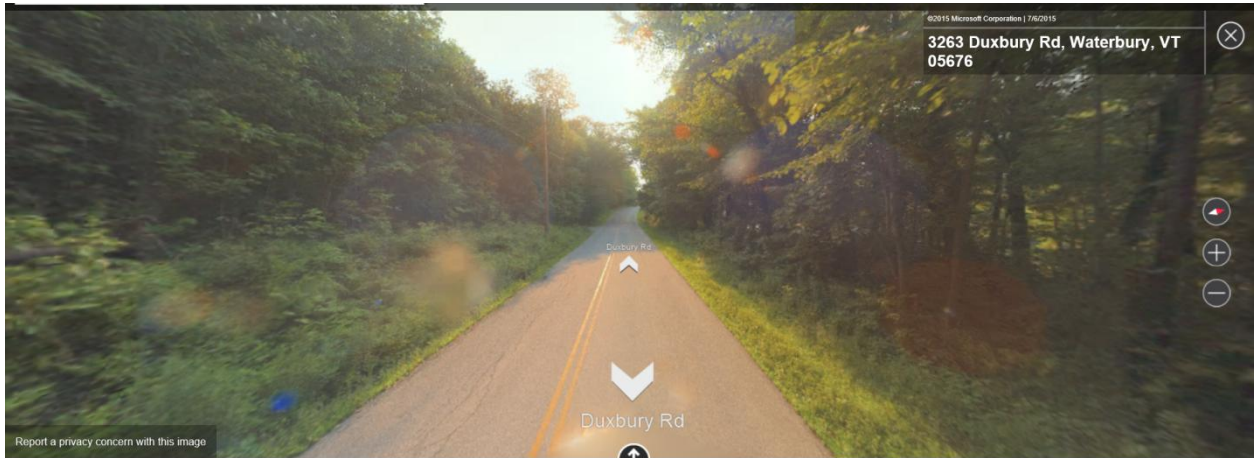

Western portion of River Road (Duxbury Road), with river close to road in places (Bing Maps image)

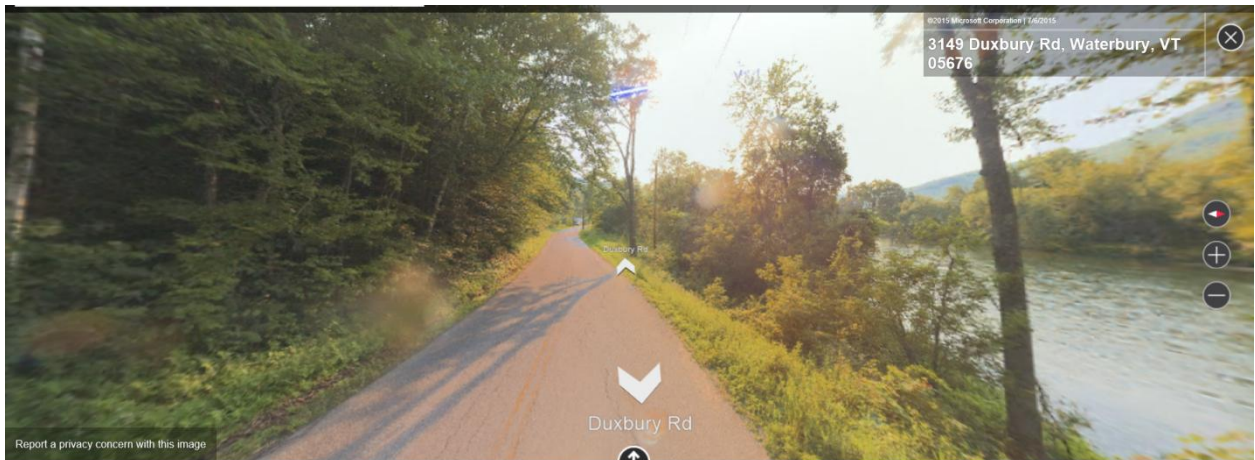

## LARGER STRUCTURES WITHIN STUDY AREA

I-89 and US Route 2 bridges over Little River, facing south



Constructed shelf on west side under Little River bridge



Pineo Brook inlet, north side of US Route 2, facing south



Interior of Pineo Brook culvert, with I-89 median opening visible





US Route 2 bridge over Joiner Brook



I-89 over Joiner Brook



## CAMERA HARDWARE AND DEPLOYMENT AT LITTLE RIVER BRIDGE

Fabricated housing for angling camera down



Fabricated housing for angling camera to the side



Back side of fabricated housing for angling to the side



Cameras being installed on abutment, one angled down, the other angled to the side



Camera on western bridge abutment



# SELECTED WILDLIFE PHOTOGRAPHS

Deer on constructed shelf under Little River bridge



Black bears interacting



Bear and cubs, Little River Remote



Bull moose, Little River Remote



Barred owl, Green Mountain Power Far



Bobcat playing with chipmunk, Joiner Brook Far



Fisher with squirrel



Bobcat on constructed shelf under Little River bridge



Deer along right-of-way fence



Fox exiting culvert (VTrans photo)



Turkeys in courtship behavior



# 1960 PHOTOGRAPHS OF CORRIDOR

Pre-construction



During construction





**Bolton Waterbury STP 2709(1)**

**Wildlife Connectivity Study**

## **Appendix B**

# **CAMERA DATES OF DEPLOYMENT AND CALCULATIONS**





**APPENDIX B. Camera Dates of Deployment and Calculations**

<b>CORRIDOR LOCATION (BOLD) AND CAMERA STATION</b>	<b>INSTALLED</b>	<b>LAST CHECKED OR CEASED FUNCTION</b>	<b>TOTAL DAYS OUT</b>	<b>DAYS NON- FUNCTIONAL BEFORE LAST DATE (SEE COMMENTS)</b>	<b>NET DAYS OUT</b>	<b>NET YEARS OUT</b>	<b>NET DAYS/ CORRIDOR LOCATION</b>	<b>NET YEARS OUT/ CORRIDOR LOCATION</b>	<b>COMMENTS</b>
<b>CULV/BRIDGE</b>							<b>6556</b>	<b>17.96</b>	
Joiner Brook Inlet 18	10/18/2013	10/29/2015	741	0	741	2.03			THIS CAMERA HAD NO WILDLIFE PHOTOS THROUGHOUT
Joiner Brook Inlet 5	9/30/2013	10/29/2015	759	0	759	2.08			
Little River Bridge East Pier to River	11/4/2013	10/13/2015	708	0	708	1.94			
Little River Bridge East Pier to Slope	11/4/2013	10/13/2015	708	0	708	1.94			
Little River Bridge West Abutment	11/4/2013	10/6/2015	701	0	701	1.92			
Little River Bridge West Pier to River	11/4/2013	10/13/2015	708	0	708	1.94			
Little River Bridge West Pier to Slope	11/4/2013	10/13/2015	708	0	708	1.94			
Pineo Brook Inlet	9/9/2013	10/8/2015	759	0	759	2.08			
Sharkeyville Stream Inlet	9/9/2013	10/13/2015	764	0	764	2.09			
<b>FAR</b>							<b>8986</b>	<b>24.62</b>	
Camel's Hump Boundary - Far	9/17/2013	10/6/2015	749	0	749	2.05			
Camel's Hump Road - Far	9/17/2013	10/6/2015	749	0	749	2.05			
Farr Landing Far	9/20/2013	10/6/2015	746	0	746	2.04			
Green Mountain Power Far	9/17/2013	10/8/2015	751	0	751	2.06			
Joiner Brook Far	10/2/2013	10/12/2015	740	0	740	2.03			

CORRIDOR LOCATION (BOLD) AND CAMERA STATION	INSTALLED	LAST CHECKED OR CEASED FUNCTION	TOTAL DAYS OUT	DAYS NON- FUNCTIONAL BEFORE LAST DATE (SEE COMMENTS)	NET DAYS OUT	NET YEARS OUT	NET DAYS/ CORRIDOR LOCATION	NET YEARS OUT/ CORRIDOR LOCATION	COMMENTS
Logging Road Far	9/17/2013	10/6/2015	749	0	749	2.05			NO PHOTOS 11/22/2013 TO 5/8/2014, BUT THIS IS SIMILAR TO FOLLOWING WINTER; ASSUME CAMERA ACTIVE THRUOUT
Little River Far	9/20/2013	10/6/2015	746	0	746	2.04			
Long Trail Far	9/17/2013	10/6/2015	749	0	749	2.05			
Pineo Brook Far	9/9/2013	10/8/2015	759	0	759	2.08			
River Road East Far	9/17/2013	10/6/2015	749	0	749	2.05			
Sharkeyville Funnel Far	9/24/2013	10/6/2015	742	0	742	2.03			
Sharkeyville Stream Far	9/9/2013	10/6/2015	757	0	757	2.07			
<b>NEAR</b>							<b>8815</b>	<b>24.15</b>	
Camel's Hump Boundary Near	9/17/2013	10/6/2015	749	0	749	2.05			
Camel's Hump Road Near	9/17/2013	10/6/2015	749	107	642	1.76			NO PHOTOS 7/30/2014 THRU 11/13/2014 (107 DAYS); LAST PHOTO 7/29 SHOWS KID THROWING ROCK. ASSUME CAMERA DAMAGED.
Farr's Landing Near	9/20/2013	10/6/2015	746	0	746	2.04			
Green Mountain Power Near	9/17/2013	10/8/2015	751	0	751	2.06			
Joiner Brook Near	10/2/2013	10/12/2015	740	69	671	1.84			NO PHOTOS 9/6/2014 THRU 11/13/2014 (69 DAYS) DUE TO LEAF PHOTOS
Logging Road Near	9/17/2013	10/6/2015	749	0	749	2.05			
Little River Near	9/20/2013	10/6/2015	746	0	746	2.04			

<b>CORRIDOR LOCATION (BOLD) AND CAMERA STATION</b>	<b>INSTALLED</b>	<b>LAST CHECKED OR CEASED FUNCTION</b>	<b>TOTAL DAYS OUT</b>	<b>DAYS NON- FUNCTIONAL BEFORE LAST DATE (SEE COMMENTS)</b>	<b>NET DAYS OUT</b>	<b>NET YEARS OUT</b>	<b>NET DAYS/ CORRIDOR LOCATION</b>	<b>NET YEARS OUT/ CORRIDOR LOCATION</b>	<b>COMMENTS</b>
Long Trail Near	9/17/2013	10/6/2015	749	0	749	2.05			THIS CAMERA HAD NO WILDLIFE PHOTOS THROUGHOUT
Pineo Brook Near	9/9/2013	10/6/2015	757	0	757	2.07			
River Road East Near	9/17/2013	10/6/2015	749	0	749	2.05			
Sharkeyville Funnel Near	9/17/2013	10/6/2015	749	0	749	2.05			
Sharkeyville Stream Near	9/9/2013	10/6/2015	757	0	757	2.07			NO PHOTOS AUG/SEP 2014, BUT CAMERA BELIEVED TO BE FUNCTIONING
<b>REMOTE</b>							<b>4353</b>	<b>11.93</b>	
Bolton Valley Remote	9/17/2013	10/8/2015	751	0	751	2.06			
Honey Hollow Remote	9/20/2013	10/6/2015	746	0	746	2.04			
Little River Remote	9/10/2013	10/6/2015	756	0	756	2.07			
Richardson Road Remote	9/24/2013	10/12/2015	748	0	748	2.05			
Scrabble Hill Remote	9/24/2013	10/6/2015	742	0	742	2.03			
Sharkeyville Upland Remote	9/9/2013	5/12/2015	610	0	610	1.67			NO PHOTOS AFTER 5/12/2015
<b>WINOOSKI RIVER</b>							<b>759</b>	<b>2.08</b>	
Winooski River	9/9/2013	10/8/2015	759	0	759	2.08			
<b>GRAND TOTALS</b>			<b>29645</b>	<b>176</b>	<b>29469</b>	<b>80.74</b>	<b>29469</b>	<b>80.74</b>	
<b>GRAND TOTALS EXCLUDING WINOOSKI RIVER (MANY WATERFOWL)</b>			<b>28886</b>	<b>176</b>	<b>28710</b>	<b>78.66</b>	<b>28710</b>	<b>78.66</b>	



**Bolton Waterbury STP 2709(1)**

**Wildlife Connectivity Study**

## **Appendix C**

# **TRANSECT LENGTHS AND CALCULATIONS**



**APPENDIX C. Transect Lengths and Calculations**

<b>Transect and Segment</b>	<b>Length of Transect or Segment (Feet)</b>	<b>Length in 400-Foot Segments</b>	<b>Antecedent Track Nights</b>	<b>Conversion to 90-Day Basis</b>	<b>Net Factor to Convert to per 400 Feet per 90 Days</b>
<b>CAMELS HUMP BOUNDARY</b>	1803				
1-400	408	1.02	9	10	9.81
401-800	517	1.29	9	10	7.73
801-1200	438	1.09	9	10	9.14
1201-1600	440	1.10	9	10	9.09
<b>CAMELS HUMP ROAD</b>	1216				
1-400	410	1.02	9	10	9.77
401-800	450	1.12	9	10	8.90
801-1200	356	0.89	9	10	11.22
<b>FARR'S LANDING</b>	2299				
1-400	465	1.16	9	10	8.60
401-800	562	1.41	9	10	7.11
801-1200	497	1.24	9	10	8.05
1201-1600	775	1.94	9	10	5.16
<b>GREEN MOUNTAIN POWER</b>	1939				
1-400	550	1.38	9	10	7.27
401-800	557	1.39	9	10	7.18
801-1200	424	1.06	9	10	9.44
1201-1600	408	1.02	9	10	9.81
<b>JOINER BROOK</b>	1903				
1-400	559	1.40	9	10	7.16
401-800	417	1.04	9	10	9.58
801-1200	449	1.12	9	10	8.91
1201-1600	478	1.20	9	10	8.36
<b>LITTLE RIVER</b>	1539				
1-400	504	1.26	9	10	7.93
401-800	407	1.02	9	10	9.83
801-1200	445	1.11	9	10	8.98
1201-1600	182	0.46	9	10	21.96
<b>LOGGING ROAD</b>	1748				
1-400	441	1.10	9	10	9.07
401-800	457	1.14	9	10	8.74
801-1200	419	1.05	9	10	9.55
1201-1600	431	1.08	9	10	9.28
<b>LONG TRAIL</b>	2136				
1-400	406	1.02	9	10	9.85
401-800	436	1.09	9	10	9.17



Transect and Segment	Length of Transect or Segment (Feet)	Length in 400-Foot Segments	Antecedent Track Nights	Conversion to 90-Day Basis	Net Factor to Convert to per 400 Feet per 90 Days
801-1200	849	2.12	9	10	4.71
1201-1600	445	1.11	9	10	9.00
PINEO BROOK	1716				
1-400	425	1.06	9	10	9.42
401-800	435	1.09	9	10	9.19
801-1200	444	1.11	9	10	9.01
1201-1600	411	1.03	9	10	9.72
RIVER ROAD EAST	1670				
1-400	409	1.02	10	9	8.80
401-800	412	1.03	10	9	8.75
801-1200	414	1.04	10	9	8.69
1201-1600	435	1.09	10	9	8.28
SHARKEYVILLE FUNNEL	1952				
1-400	546	1.36	9	10	7.33
401-800	445	1.11	9	10	8.99
801-1200	404	1.01	9	10	9.91
1201-1600	558	1.39	9	10	7.17
SHARKEYVILLE STREAM	1684				
1-400	404	1.01	9	10	9.89
401-800	406	1.02	9	10	9.85
801-1200	417	1.04	9	10	9.59
1201-1600	456	1.14	9	10	8.77
ALL TRANSECTS	21603	54.01	The "All Transect" results were		
Length of 0-400	5526	13.81	tabulated using transect data		
Length of 401-800	5502	13.76	which was first converted to		
Length of 801-1200	5556	13.89	a 90-day basis		
Length of 1201-1600	5019	12.55			

## Appendix O: Local Input

## Local & Regional Input Questionnaire

---

### Project Summary

This project, **PROJ #**, focuses on **PID 68002** on **US Route 2 and Interstate-89** in **Waterbury**, Vermont. The culvert is deteriorating and is in need of either a major maintenance action or replacement. Potential options being considered for this project include a new liner applied to the interior of the existing culvert pipe, removal of the existing pipe and replacement with a new culvert placed in the same location, or removal of the existing pipe and replacement in a new location. It is possible that VTrans will recommend a road closure and detour traffic away from the project site for the duration of the work. Efforts will be made to limit the detour to State roads.

### Community Considerations

1. Are there regularly scheduled public events in the community that will generate increased traffic (e.g. vehicular, bicycles and/or pedestrians), or may be difficult to stage if the culvert is closed during construction? Examples include annual bike races, festivals, parades, cultural events, weekly farmers market, concerts, etc. that could be impacted? If yes, please provide approximate date, location and event organizers' contact info.
2. Is there a "slow season" or period of time from May through October where traffic is less or no events are scheduled?
3. Please describe the location of the Town garage, emergency responders (fire, police, ambulance) and emergency response routes that might be affected by the closure of the culvert, one-way traffic, or lane closures and provide contact information (names, address, email addresses, and phone numbers).
4. Are there businesses (including agricultural operations and industrial parks) or delivery services (fuel or goods) that would be adversely impacted either by a detour or due to work zone proximity?
5. Are there important public buildings (town hall, community center, senior center, library) or community facilities (recreational fields, town green, etc.) close to the project?
6. What other municipal operations could be adversely affected by a road/culvert closure or detour?

## Local & Regional Input Questionnaire

---

7. Are there any town highways that might be adversely impacted by traffic bypassing the construction on other local roads? Please indicate which roads may be affected and their condition (paved/unpaved, narrow, weight-limited culverts, etc), including those that may be or go into other towns.
8. Is there a local business association, chamber of commerce, regional development corporation, or other downtown group that we should be working with? If known, please provide name, organization, email, and phone number.
9. Are there any public transit services or stops that use the culvert or transit routes in the vicinity that may be affected if they become the detour route?

### **Schools**

1. Where are the schools in your community and what are their yearly schedules (example: first week in September to third week in June)?
2. Is this project on specific routes that school buses or students use to walk to and from school?
3. Are there recreational facilities associated with the schools nearby (other than at the school)?

### **Pedestrians and Bicyclists**

1. What is the current level of bicycle and pedestrian use on the culvert?
2. Are the current lane and shoulder widths adequate for pedestrian and bicycle use?
3. Does the community feel there is a need for a sidewalk or bike lane over the culvert?
4. Is pedestrian and bicycle traffic heavy enough that it should be accommodated during construction?

## Local & Regional Input Questionnaire

---

5. Does the Town have plans to construct either pedestrian or bicycle facilities leading up to the culvert? Please provide any planning documents demonstrating this (scoping study, master plan, corridor study, town or regional plan).
6. In the vicinity of the culvert, is there a land use pattern, existing generators of pedestrian and/or bicycle traffic, or zoning that will support development that is likely to lead to significant levels of walking and bicycling?

### **Design Considerations**

1. Are there any concerns with the alignment of the existing culvert? For example, if the culvert is located on a curve, has this created any problems that we should be aware of?
2. Are there any concerns with the width of the existing culvert?
3. Are there any special aesthetic considerations we should be aware of?
4. Does the location have a history of flooding? If yes, please explain.
5. Are there any known Hazardous Material Sites near the project site?
6. Are there any known historic, archeological and/or other environmental resource issues near the project site?
7. Are there any existing, pending, or planned municipal utility projects (communications, lighting, drainage, water, wastewater, etc.) near the project that should be considered?
8. Are there any other issues that are important for us to understand and consider?

## Local & Regional Input Questionnaire

---

### **Land Use & Zoning**

1. Please provide a copy of your existing and future land use map or zoning map, if applicable.
2. Are there any existing, pending or planned development proposal that would impact future transportation patterns near the culvert? If so, please explain.
3. Is there any planned expansion of public transit or intercity transit service in the project area? Please provide the name and contact information for the relevant public transit provider.

### **Communications**

1. Please identify any local communication outlets that are available for us to use in communicating with the local population. Include weekly or daily newspapers, blogs, radio, public access TV, Facebook, Front Page Forum, etc. Also include any unconventional means such as local low-power FM.
2. Other than people/organizations already referenced in this questionnaire, are there any others who should be kept in the loop as the project moves forward?

## Appendix P: Operations Input

## Bridge Scoping Project PROJ### Operations Input Questionnaire

---

The Structures Section has begun the scoping process for PROJ###, ROUTE ##, Bridge ##, over the FEATURE. This is a BRIDGE TYPE bridge constructed in YEAR. The Structure Inspection, Inventory, and Appraisal Sheet (attached) rates the deck as # (RATING), the superstructure as # (RATING), and the substructure as # (RATING). We are interested in hearing your thoughts regarding the items listed below. Leave it blank if you don't wish to comment on a particular item.

1. What are your thoughts on the general condition of this culvert and the general maintenance effort required to keep it in service?
2. What are your comments on the current geometry and alignment of the road overt the culvert (curve, sag, banking, sight distance)?
3. Do you feel that the posted speed limit is appropriate?
4. Is the current roadway width adequate for winter maintenance including snow plowing?
5. Are the railings constantly in need of repair or replacement? What type of railing works best for your district?
6. Are you aware of any unpermitted driveways within close proximity to the culvert? We frequently encounter driveways that prevent us from meeting railing and safety standards.
7. Are you aware of abutting property owners that are likely to need special attention during the planning and construction phases? These could be people with disabilities, elderly, or simply folks who feel they have been unfairly treated in the past.
8. Do you find that extra effort is required to keep the slopes and river banks around the culvert in a stable condition? Is there frequent flood damage that requires repair?



**Bridge Scoping Project PROJ###**  
**Operations Input Questionnaire**

---

9. Does this culvert seem to catch an unusual amount of debris from the waterway?
  
10. Are you familiar with traffic volumes in the area of this project?
  
11. Do you think a closure with off-site detour and accelerated construction would be appropriate?  
Do you have any opinion about a possible detour route, assuming that we use State route for State projects and any route for Town projects? Are there locations on a potential detour that are already congested that we should consider avoiding?
  
12. Please describe any larger projects that you have completed that may not be reflected on the attached Appraisal sheet, such as deck patches, paving patches, railing replacement with new type, steel coating, etc.
  
13. Are there any drainage issues that we should address on this project?
  
14. Are you aware of any complaints that the public has about issues that we can address on this project?
  
15. Is there anything else we should be aware of?

## Appendix Q: Crash Data

**Vermont Agency of Transportation**  
**General Yearly Summaries - Crash Listing: State Highways and All Federal Aid Highway Systems**  
 From 01/01/11 To 12/31/15 General Yearly Summaries Information

* Reporting Agency/ Number	Town	Mile Marker	Date MM/DD/YY	Time	Weather	Contributing Circumstances	Direction Of Collision	Number Of Injuries	Number Of Fatalities	Number Of Untimely Deaths	Direction	Road Group
<b>Route: I-89 Continued ...</b>												
VTVSP1200/15A30 5988	Waterbury	66	12/15/2015	09:11				0	0	0		SH
VTVSP1200/14A30 0968	Waterbury	66.1	03/01/2014	03:26	Clear	No improper driving, Wrong side or wrong way, Under the influence of medication/drugs/alcohol	Head On	1	0	1	N	SH
VTVSP1200/11A30 4033	Waterbury	66.12	09/18/2011	11:00	Clear	Distracted, Failure to keep in proper lane, No improper driving	Same Direction Sideswipe	0	0	0	S	SH
VTVSP1200/13A30 0744	Waterbury	66.2	02/20/2013	07:20				0	0	0		SH
VTVSP1200/13A30 4411	Waterbury	66.2	10/18/2013	23:43	Cloudy	Under the influence of medication/drugs/alcohol, Failure to keep in proper lane	Single Vehicle Crash	1	0	0		SH
VTVSP1200/15A30 1632	Waterbury	66.2	04/09/2015	06:40				0	0	0		SH
VTVSP1200/14A30 5347	Waterbury	66.3	12/06/2014	08:15	Snow	Failure to keep in proper lane, Driving too fast for conditions, No improper driving	Same Direction Sideswipe	0	0	0	S	SH
VTVSP1200/11A30 3534	Waterbury	66.45	08/15/2011	11:59	Rain	Driving too fast for conditions	Single Vehicle Crash	2	0	0	N	SH
VTVSP0100/14A30 0656	Waterbury	66.5	02/11/2014	08:00	Clear	No improper driving, Driving too fast for conditions, Failure to keep in proper lane	Other - Explain in Narrative	0	0	0	S	SH
VTVSP1200/15A30 1248	Waterbury	66.5	03/15/2015	01:15				0	0	0		SH
VTVSP1200/12A30 2371	Waterbury	66.6	06/08/2012	06:15	Clear	Followed too closely, No improper driving	Rear End	1	0	0	N	SH
VTVSP1200/13A30 1717	Waterbury	66.6	05/01/2013	18:08				0	0	0		SH
VTVSP1200/13A30 4909	Waterbury	66.6	11/22/2013	16:50	Cloudy	Failure to keep in proper lane, Visibility obstructed, No improper driving	Other - Explain in Narrative	0	0	0	S	SH
VTVSP1200/11A30 4202	Waterbury	66.7	09/28/2011	18:25	Rain	Driving too fast for conditions	Single Vehicle Crash	0	0	0	N	SH
VTVSP1200/11A30 4389	Waterbury	66.7	10/14/2011	19:30	Rain	Driving too fast for conditions, Failure to keep in proper lane	Single Vehicle Crash	1	0	0	S	SH
VTVSP1200/14A30 1188	Waterbury	66.75	03/15/2014	21:41				0	0	0		SH
VTVSP1200/15A30 4575	Waterbury	66.75	09/18/2015	07:34	Cloudy	Followed too closely, No improper driving, Made an improper turn	Other - Explain in Narrative	0	0	0	N	SH
VTVSP1200/14A30 0593	Waterbury	66.8	02/06/2014	12:15				0	0	0		SH
VTDMV0004/14MV 001964	Waterbury	66.8	03/20/2014	07:27	Snow		Same Direction Sideswipe	0	0	0	S	SH
VTVSP1200/12A30 2308	Waterbury	66.84	06/04/2012	10:30	Rain	No improper driving, Driving too fast for conditions, Operating vehicle in erratic, reckless, careless, negligent, or aggressive manner	Same Direction Sideswipe	0	0	0	N	SH
VTVSP1200/12A30 4249	Waterbury	66.88	09/26/2012	17:40	Cloudy	Failure to keep in proper lane	Single Vehicle Crash	0	0	0	S	SH
VTVSP1200/11A30 1124	Waterbury	66.95	03/06/2011	13:44	Snow	Driving too fast for conditions	Single Vehicle Crash	1	0	0	N	SH
VTVSP1200/12A30 0205	Waterbury	66.98	01/13/2012	22:13	Sleet, Hail (Freezing Rain or Drizzle)	Driving too fast for conditions	Single Vehicle Crash	0	0	0	S	SH
VTVSP1200/13A30 0616	Waterbury	67	02/10/2013	10:47				0	0	0		SH
VTVSP1200/13A10 1027	Waterbury	67	03/15/2013	20:30	Snow	Driving too fast for conditions	Single Vehicle Crash	0	0	0	N	SH
VTVSP1200/13A30 1124	Waterbury	67	03/19/2013	10:49				0	0	0		SH
VTVSP1200/13A30 1710	Waterbury	67	05/01/2013	08:08				0	0	0		SH

\*Crash occurred prior to the last Highway Improvement Project. This data should not be used in a crash analysis. UNK indicates the Mile Marker is Unknown.

General Yearly Summaries - Crash Listing: State Highways and All Federal Aid Highway Systems  
From 01/01/11 To 12/31/15 General Yearly Summaries Information

PID-68002 is located at  
MM. 67.49 on I-89

* Reporting Agency/ Number	Town	Mile Marker	Date MM/DD/YY	Time	Weather	Contributing Circumstances	Direction Of Collision	Number Of Injuries	Number Of Fatalities	Number Of Untimely Deaths	Direction	Road Group
<b>Route: I-89 Continued ...</b>												
VTVSP1200/13A30 2082	Waterbury	67	05/26/2013	15:00				0	0	0		SH
VTVSP1200/13A30 4910	Waterbury	67	11/22/2013	17:20				0	0	0		SH
VTVSP1200/14A30 0694	Waterbury	67	02/14/2014	07:33				0	0	0		SH
VTVSP1200/14A30 0822	Waterbury	67	02/21/2014	06:49				0	0	0		SH
VTVSP1200/14A30 3555	Waterbury	67	08/16/2014		Clear	Swerving or avoiding due to wind, slippery surface, vehicle, object, non-motorist in roadway etc	Single Vehicle Crash	0	0	0	N	SH
VTVSP1200/15A30 0333	Waterbury	67	01/19/2015	12:08				0	0	0		SH
VTVSP1200/15A30 0552	Waterbury	67	02/01/2015	08:13				0	0	0		SH
VTVSP1200/15A30 0724	Waterbury	67	02/09/2015	08:25				0	0	0		SH
VTVSP1200/15A30 0812	Waterbury	67	02/14/2015	15:59				0	0	0		SH
VTVSP1200/15A30 0813	Waterbury	67	02/14/2015	16:07				0	0	0		SH
VTVSP1200/15A30 0825	Waterbury	67	02/15/2015	08:17				0	0	0		SH
VTVSP1200/15A30 1285	Waterbury	67	03/17/2015	14:55				0	0	0		SH
VTVSP1200/15A30 5480	Waterbury	67	11/12/2015	13:12				0	0	0		SH
VTVSP1200/15A30 5613	Waterbury	67	11/21/2015	03:09				0	0	0		SH
VTVSP1200/14A30 5788	Waterbury	67.01	12/29/2014	07:00	Snow	No improper driving, Driving too fast for conditions	Rear End	0	0	0	N	SH
VTVSP1200/13A30 2429	Waterbury	67.4	06/19/2013	04:39	Clear	No improper driving	Single Vehicle Crash	0	0	0	N	SH
VTVSP1200/12A30 3267	Waterbury	67.5	07/27/2012	13:00	Cloudy	Failure to keep in proper lane	Single Vehicle Crash	1	0	0	S	SH
VTVSP1200/14A30 0802	Waterbury	67.55	02/19/2014	16:11				0	0	0		SH
VTVSP1200/14A30 1003	Waterbury	67.55	03/03/2014	20:50	Clear	No improper driving	Single Vehicle Crash	0	0	0		SH
VTVSP1200/14A30 0429	Waterbury	67.6	01/26/2014	17:45	Cloudy	Followed too closely, Other improper action	Rear End	0	0	0	S	SH
VTDMV0004/14MV 000863	Waterbury	67.6	02/05/2014	12:40	Snow	Driving too fast for conditions	Head On	0	0	0	S	SH
VTVSP1200/14A30 5398	Waterbury	67.6	12/09/2014	07:00	Snow	Failure to keep in proper lane	Single Vehicle Crash	0	0	0	S	SH
VTVSP1200/15A30 1264	Waterbury	67.6	03/15/2015	17:06				0	0	0		SH
VTVSP1200/12A30 0373	Waterbury	67.64	01/21/2012	20:46	Clear	Failure to keep in proper lane	Single Vehicle Crash	0	0	0	N	SH
VTVSP1200/11A30 0929	Waterbury	UNK	02/26/2011	12:55	Cloudy	Fatigued, asleep, Failure to keep in proper lane	Single Vehicle Crash	1	0	0	S	SH
VTVSP1200/11A30 5301	Waterbury	UNK	12/23/2011	08:22	Snow	Driving too fast for conditions	Single Vehicle Crash	0	0	0	S	SH
VTVSP1200/11A30 5330	Waterbury	UNK	12/25/2011	13:47	Snow	Driving too fast for conditions	Single Vehicle Crash	1	0	0	S	SH
VTVSP1200/11A30 5366	Waterbury	UNK	12/27/2011	21:00	Snow		Right Turn and Thru, Broadside ^<--	0	0	0	N	SH

\*Crash occurred prior to the last Highway Improvement Project. This data should not be used in a crash analysis. UNK indicates the Mile Marker is Unknown.

**Vermont Agency of Transportation**  
**General Yearly Summaries - Crash Listing: State Highways and All Federal Aid Highway Systems**  
 From 01/01/11 To 12/31/15 General Yearly Summaries Information

* Reporting Agency/ Number	Town	Mile Marker	Date MM/DD/YY	Time	Weather	Contributing Circumstances	Direction Of Collision	Number Of Injuries	Number Of Fatalities	Number Of Untimely Deaths	Direction	Road Group
<b>Route: I-89 Continued ...</b>												
VTVSP1200/13A30 1141	Waterbury	UNK	03/19/2013	19:42				0	0	0		SH
VTVSP1200/13A30 1474	Waterbury	UNK	04/12/2013	21:00				0	0	0		SH
VTVSP1200/13A30 3349	Waterbury	UNK	08/15/2013	02:17	Fog, Smog, Smoke	Fatigued, asleep, No improper driving	Rear End	1	0	0	S	Other
VTVSP1200/13A30 4948	Waterbury	UNK	11/24/2013	08:10				0	0	0		SH
VTVSP1200/14A30 0030	Waterbury	UNK	01/02/2014	12:33	Snow	Driving too fast for conditions	Single Vehicle Crash	0	0	0	S	SH
VTVSP1200/14A30 0605	Waterbury	UNK	02/06/2014	19:35	Cloudy	No improper driving, Unknown	Other - Explain in Narrative	0	0	0		Other
VTVSP1200/14A30 1100	Waterbury	UNK	03/12/2014	07:11				0	0	0		Ramp/Spur
VTVSP1200/14A30 1127	Waterbury	UNK	03/13/2014	08:36				0	0	0		SH
VTVSP1200/14A30 3617	Waterbury	UNK	08/21/2014	05:20	Cloudy	Inattention, Other Activity, Electronic Device	Single Vehicle Crash	1	0	0	N	SH
VTVSP1200/15A30 1249	Waterbury	UNK	03/15/2015	01:33				0	0	0		SH
VTVSP1200/14A30 0654	Bolton	67.8	02/11/2014	07:19	Clear	Driving too fast for conditions	Other - Explain in Narrative	0	0	0	N	SH
VTVSP0100/15A10 0417	Bolton	67.8	01/25/2015	09:52				0	0	0		SH
VTVSP1200/11A30 5408	Bolton	67.95	12/28/2011	17:34	Snow	Driving too fast for conditions, Failure to keep in proper lane	Same Direction Sideswipe	0	0	0	N	SH
VTVSP0100/11A10 5320	Bolton	68	12/31/2011	11:30	Cloudy	Other improper action	Single Vehicle Crash	1	0	0	S	SH
VTVSP0100/13A10 0286	Bolton	68	01/21/2013	07:07				0	0	0		SH
VTVSP0100/13A10 5274	Bolton	68	12/23/2013	16:04				0	0	0		SH
VTVSP0100/13A10 5292	Bolton	68	12/24/2013	08:35				0	0	0		SH
VTVSP0100/14A10 0788	Bolton	68	02/14/2014	22:57				0	0	0		SH
VTVSP0100/14A10 4187	Bolton	68	09/20/2014	03:04				0	0	0		SH
VTVSP0100/14A10 5819	Bolton	68	12/18/2014	21:21	Rain	No improper driving, Driving too fast for conditions	Rear End	1	0	0	S	SH
VTVSP0100/14A10 5897	Bolton	68	12/18/2014	20:25	Snow		Rear End	0	0	0	S	SH
VTVSP0100/15A10 0323	Bolton	68	01/19/2015	17:39				0	0	0		SH
VTVSP0100/15A10 1206	Bolton	68	03/03/2015	20:30	Snow	No improper driving, Driving too fast for conditions, Followed too closely	Rear End	0	0	0	N	SH
VTVSP0100/14A10 3251	Bolton	68.05	07/20/2014	11:43	Clear	Failure to keep in proper lane	Single Vehicle Crash	1	0	0	N	SH
VTVSP1200/11A30 5271	Bolton	68.2	12/21/2011	08:30	Rain	No improper driving, Operating defective equipment, Driving too fast for conditions	Same Direction Sideswipe	0	0	0	S	SH
VTVSP0100/15A10 2727	Bolton	68.2	05/31/2015	09:04				0	0	0		SH
VTVSP1200/11A30 5333	Bolton	68.25	12/25/2011	17:00	Snow	Driving too fast for conditions, No improper driving	Same Direction Sideswipe	0	0	0	S	SH
VTVSP0100/14A10 5813	Bolton	68.3	12/18/2014	20:28	Sleet, Hail (Freezing Rain or Drizzle)	No improper driving, Driving too fast for conditions, Swerving or avoiding due to wind, slippery surface, vehicle, object, non-motorist in roadway etc	Same Direction Sideswipe	0	0	0	S	SH

\*Crash occurred prior to the last Highway Improvement Project. This data should not be used in a crash analysis. UNK indicates the Mile Marker is Unknown.

General Yearly Summaries - Crash Listing: State Highways and All Federal Aid Highway Systems

From 01/01/11 To 12/31/15 General Yearly Summaries Information

PID-68002 is located at MM 0.25 on US-2

* Reporting Agency/ Number	Town	Mile Marker	Date MM/DD/YY	Time	Weather	Contributing Circumstances	Direction Of Collision	Number Of Injuries	Number Of Fatalities	Number Of Untimely Deaths	Direction	Road Group
<b>Route: US-2 Continued ...</b>												
VT0040800/12RM0 0991	Richmond	UNK	10/27/2012	21:02	Clear	No improper driving	Single Vehicle Crash	0	0	0	W	SH
VT0040800/13RM0 0803	Richmond	UNK	08/12/2013	13:25	Clear	Technology Related Distraction	Rear End	2	0	0	E	SH
VTVSP0100/11A10 3687	Bolton	0.5	09/04/2011	15:43	Cloudy	Driving too fast for conditions	Single Vehicle Crash	1	0	0		SH
VTVSP0100/15A10 3281	Bolton	1.11	06/26/2015	21:33				0	0	0		SH
VTVSP0100/15A10 0650	Bolton	1.2	02/04/2015	10:45				0	0	0		SH
VTVSP0100/14A10 2958	Bolton	2.1	07/03/2014	17:30	Cloudy	Failure to keep in proper lane	Single Vehicle Crash	0	0	0	S	SH
VTVSP0100/14A10 0816	Bolton	2.16	02/16/2014	07:15	Clear	Driving too fast for conditions	Single Vehicle Crash	2	0	0	W	SH
VTVSP0100/15A10 3742	Bolton	2.84	07/20/2015	17:37	Clear	No improper driving, Failure to keep in proper lane, Operating defective equipment	Head On	0	0	0	N	SH
VTVSP0100/15A10 5187	Bolton	2.85	10/06/2015	21:18	Clear	No improper driving	Single Vehicle Crash	1	1	0		SH
VTVSP0100/15A10 0064	Bolton	3.45	01/05/2015	13:26	Cloudy	No improper driving, Followed too closely, Inattention	Same Direction Sideswipe	2	0	0	S	SH
VTVSP0100/12A10 1430	Bolton	3.47	04/22/2012	14:35	Cloudy	Other improper action, Fatigued, asleep	Head On	0	0	0	S	SH
VTVSP1200/14A30 1395	Waterbury	0.9	03/24/2014	06:22	Cloudy	Driving too fast for conditions	Single Vehicle Crash	0	0	0	E	SH
VTVSP1200/14A30 0821	Waterbury	1.15	02/20/2014	23:02				0	0	0		SH
VTVSP1200/15A30 6079	Waterbury	1.15	12/20/2015	02:10				0	0	0		SH
VTVSP1200/13A30 2448	Waterbury	1.49	06/20/2013	11:51				0	0	0		SH
VTVSP1200/11A30 2476	Waterbury	1.89	06/13/2011	17:28	Cloudy	Exceeded authorized speed limit, Failure to keep in proper lane	Other - Explain in Narrative	0	0	0	E	SH
VTVSP1200/12A30 0017	Waterbury	2.33	01/02/2012	08:24	Clear	Failure to keep in proper lane, Inattention	Single Vehicle Crash	1	0	0	W	SH
VTVSP1200/15A30 3337	Waterbury	2.42	07/12/2015	12:27				0	0	0		SH
VTVSP1200/13A30 3758	Waterbury	2.55	09/05/2013	06:41	Cloudy	Failure to keep in proper lane, Technology Related Distraction	Single Vehicle Crash	0	0	0	W	SH
VTVSP1200/14A30 5351	Waterbury	2.6	12/06/2014	09:30	Snow	No improper driving, Driving too fast for conditions, Failure to keep in proper lane	Opp Direction Sideswipe	0	0	0	E	SH
VT0120400/13WB 00891	Waterbury	3.68	11/08/2013	09:00	Cloudy		No Turns, Thru moves only, Broadside ^<	0	0	0	S	SH
VT0120400/11WB 00063	Waterbury	3.74	01/14/2011	14:04	Clear	Made an improper turn, Operating vehicle in erratic, reckless, careless, negligent, or aggressive manner	Opp Direction Sideswipe	0	0	0	S	SH
VT0120400/14WB 00226	Waterbury	3.74	03/30/2014	14:30	Cloudy	Other improper action	Left Turn and Thru, Angle Broadside -->v--	0	0	0	E	SH
VT0120400/14WB 00694	Waterbury	3.78	09/12/2014	13:49	Clear	Visibility obstructed, Followed too closely	Rear End	0	0	0	S	SH
VT0120400/11WB 00360	Waterbury	3.8	03/08/2011	08:50	Clear	Inattention	Rear End	0	0	0	S	SH
VT0120400/11WB 01698	Waterbury	3.91	12/08/2011	14:26	Clear	No improper driving, Inattention, Failed to yield right of way	Left Turn and Thru, Angle Broadside -->v--	0	0	0	E	SH
VT0120400/13WB 00261	Waterbury	4.07	04/19/2013	16:49				0	0	0	S	SH
VT0120400/13WB 00118	Waterbury	4.09	02/17/2013	01:18				0	0	0	S	SH

\*Crash occurred prior to the last Highway Improvement Project. This data should not be used in a crash analysis. UNK indicates the Mile Marker is Unknown.

## Appendix R: Detour Maps

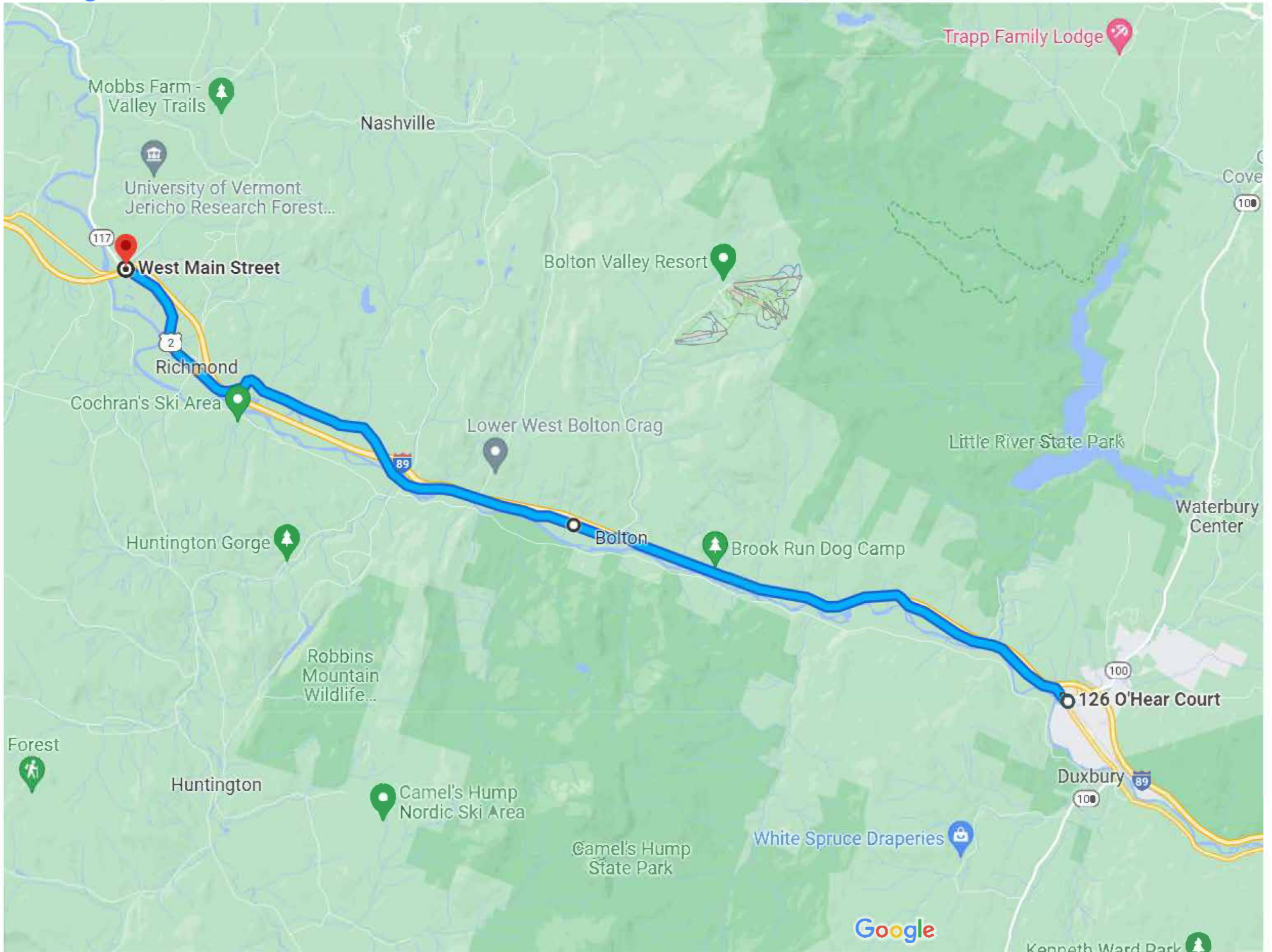





126 O'Hear Ct  
Waterbury Village Historic District, VT 05676

- ↑ 1. Head southwest on Waterbury-Stowe Rd  

---

72 ft
- ↻ 2. At the traffic circle, take the 2nd exit onto US-2  
W/N Main St  
  -  Continue to follow US-2 W
  -  Destination will be on the left

---

14.8 mi

W Main St  
Richmond, VT 05477

These directions are for planning purposes only. You may find that construction projects, traffic, weather, or other events may cause conditions to differ from the map results, and you should plan your route accordingly. You must obey all signs or notices regarding your route.

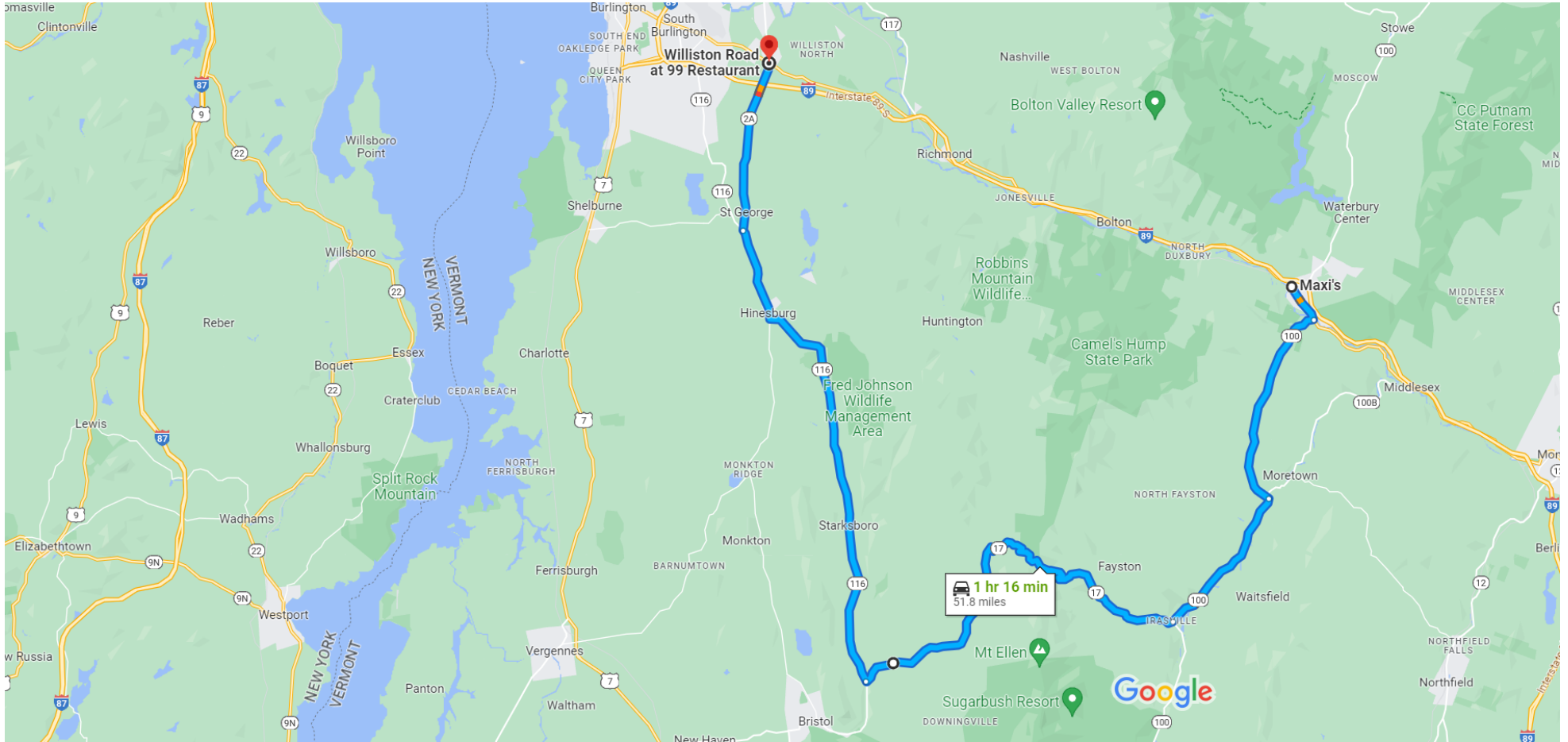









Map data ©2023 Google 2 mi

**Maxi's**  
47 N Main St, Waterbury Village Historic District, VT 05676

- ↑ 1. Head southeast on N Main St

131 ft

-  2. At the traffic circle, take the 1st exit onto N Main St/U.S. Rte 2 E  
 Continue to follow U.S. Rte 2 E  
\_\_\_\_\_ 1.3 mi
-  3. Turn right onto Vermont Rte 100 S  
\_\_\_\_\_ 7.0 mi
-  4. Turn right to stay on Vermont Rte 100 S  
\_\_\_\_\_ 5.4 mi
-  5. Slight right onto VT-17 W  
\_\_\_\_\_ 15.8 mi
-  6. Turn right onto Rte 116 N  
\_\_\_\_\_ 16.6 mi
-  7. Turn right onto VT-2A N  
\_\_\_\_\_ 5.7 mi
-  8. Slight right  
\_\_\_\_\_ 141 ft

**Williston Road at 99 Restaurant**

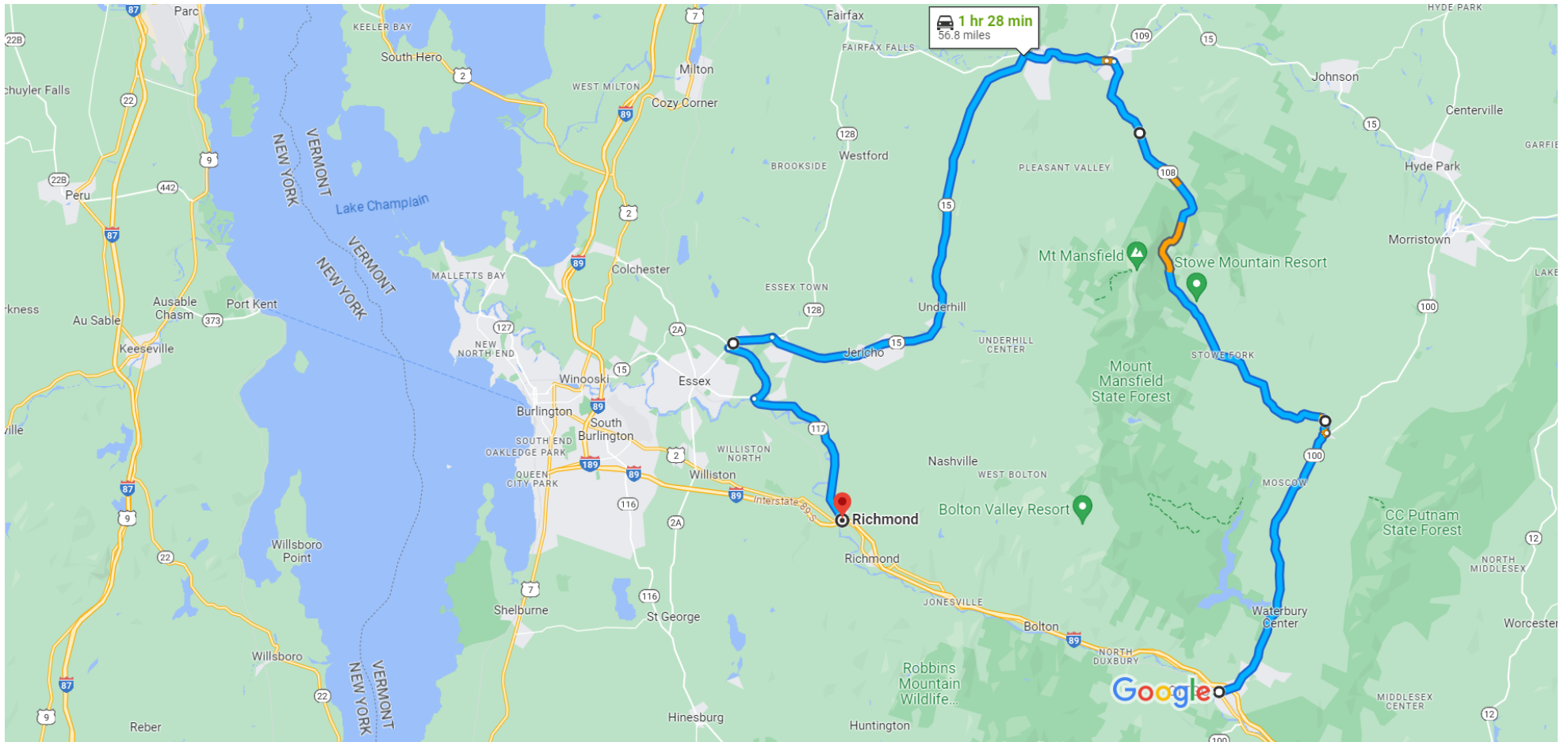

Map data ©2023 Google 2 mi

CITGO



52 N Main St, Waterbury Village Historic District, VT 05676

- 1. Head southeast on N Main St



5 sec (98 ft)

**Continue on Vermont Rte 100 N. Take VT-108 N and VT-15 W to Vermont Rte 117 E in Richmond**

1 hr 27 min (56.8 mi)

-  2. At the traffic circle, take the 2nd exit onto Vermont Rte 100 N/Waterbury-Stowe Rd  
 Continue to follow Vermont Rte 100 N

---

-  3. Turn left onto VT-108 N/Mountain Rd  
 Continue to follow VT-108 N

---

-  4. VT-108 N turns slightly left and becomes Church St/Vermont Rte 108

---

-  5. Turn left onto VT-15 W

---

-  6. Turn left to stay on VT-15 W

---

-  7. Turn left to merge onto VT-289 E

---

-  8. Turn left onto Vermont Rte 117 E

Richmond

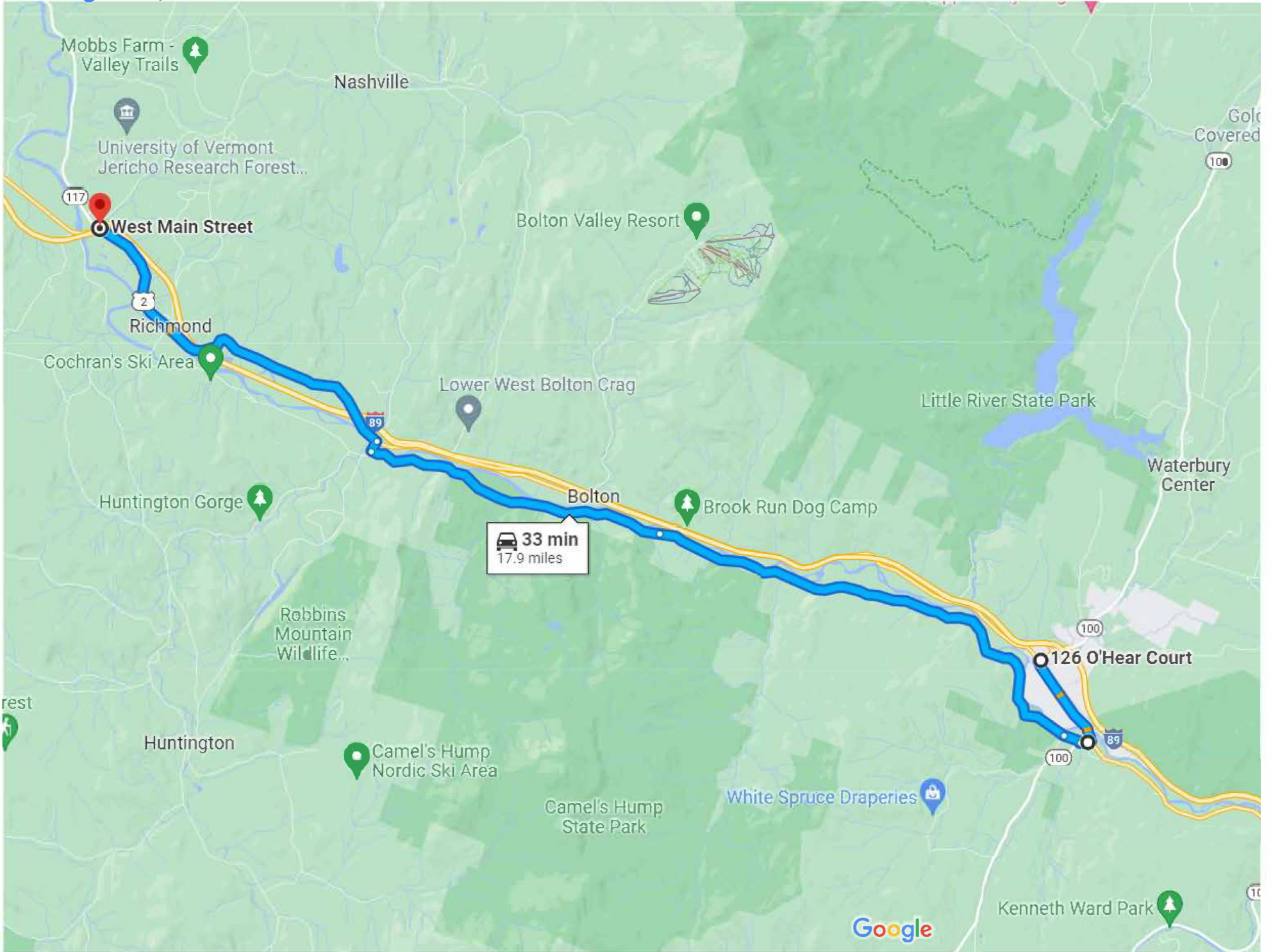

126 O'Hear Ct  
Waterbury Village Historic District, VT 05676

Take US-2 E to Main St in Duxbury

- 4 min (1.5 mi)  
↑ 1. Head southwest on Waterbury-Stowe Rd
- 72 ft  
↻ 2. At the traffic circle, take the 3rd exit onto US-2 E/N Main St  
**i** Continue to follow US-2 E
- 1.3 mi  
↪ 3. Turn right onto Vermont Rte 100 S
- 0.2 mi

Follow River Rd and Duxbury Rd to US-2 W in Richmond

- 22 min (11.2 mi)  
↪ 4. Turn right onto Main St
- 0.2 mi  
↑ 5. Continue straight onto River Rd
- 6.7 mi  
↑ 6. Continue onto Duxbury Rd
- 4.2 mi  
↪ 7. Turn right onto Cochran Rd
- 0.1 mi
- 8 min (5.2 mi)  
↵ 8. Turn left at the 1st cross street onto US-2 W  
**i** Destination will be on the left

W Main St  
Richmond, VT 05477

**Local Bypass Detour Route:**  
 - Through distance = 14.8 miles  
 - Detour distance = 17.9 miles  
 - Added distance = 3.1 miles  
 - End-to-end distance = 32.7 miles

## Appendix S: Plans



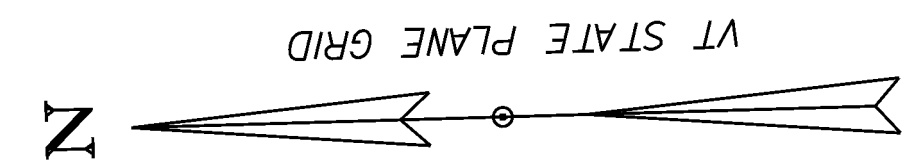

significant

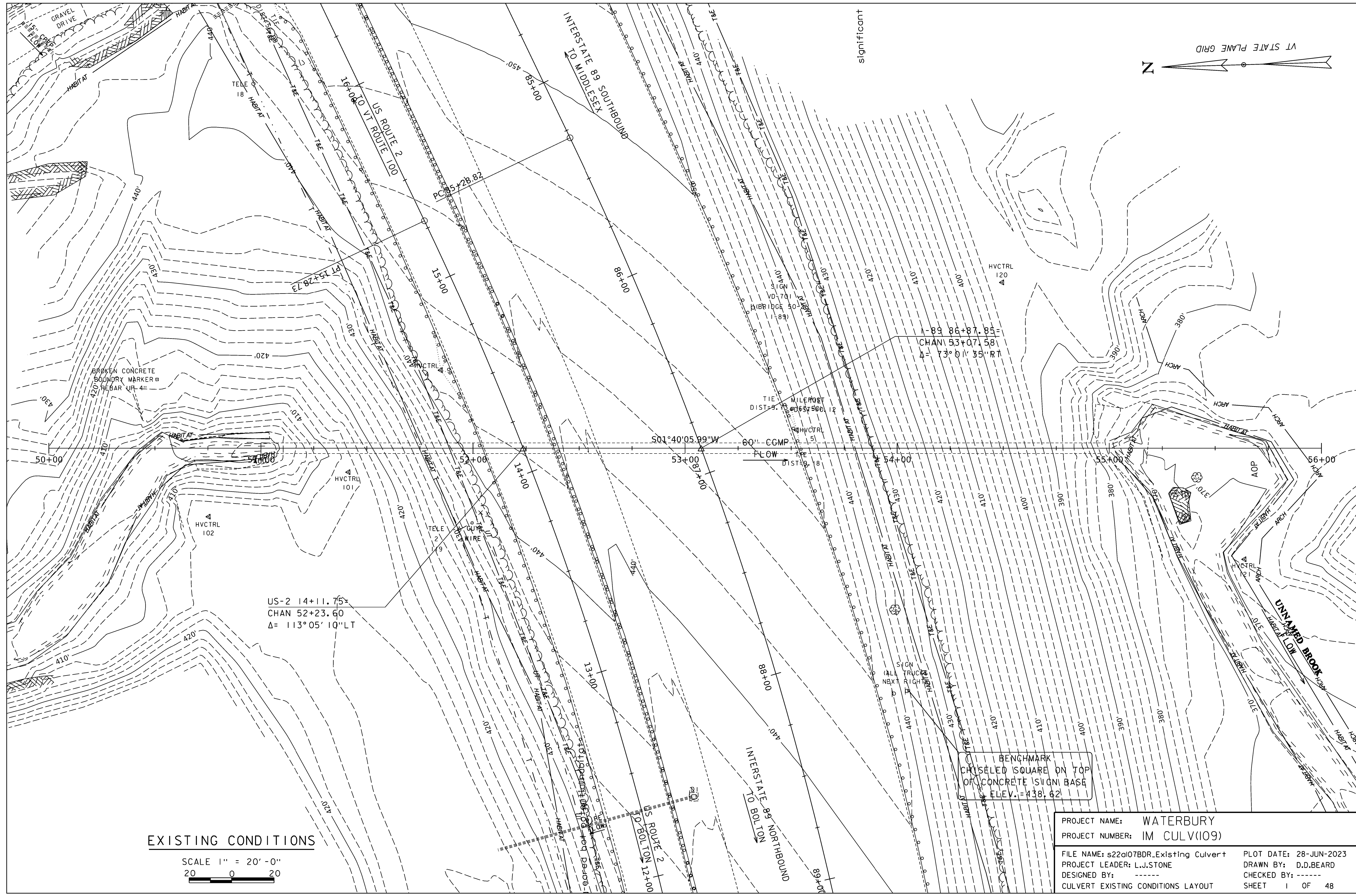

EXISTING CONDITIONS

SCALE 1" = 20'-0"  
20 0 20

PROJECT NAME:	WATERBURY	FILE NAME:	s22a107BDR.Existing Culvert	PLOT DATE:	28-JUN-2023
PROJECT NUMBER:	IM CULV(109)	PROJECT LEADER:	L.J.STONE	DRAWN BY:	D.D.BEARD
		DESIGNED BY:	-----	CHECKED BY:	-----
		CULVERT EXISTING CONDITIONS LAYOUT		SHEET	1 OF 48

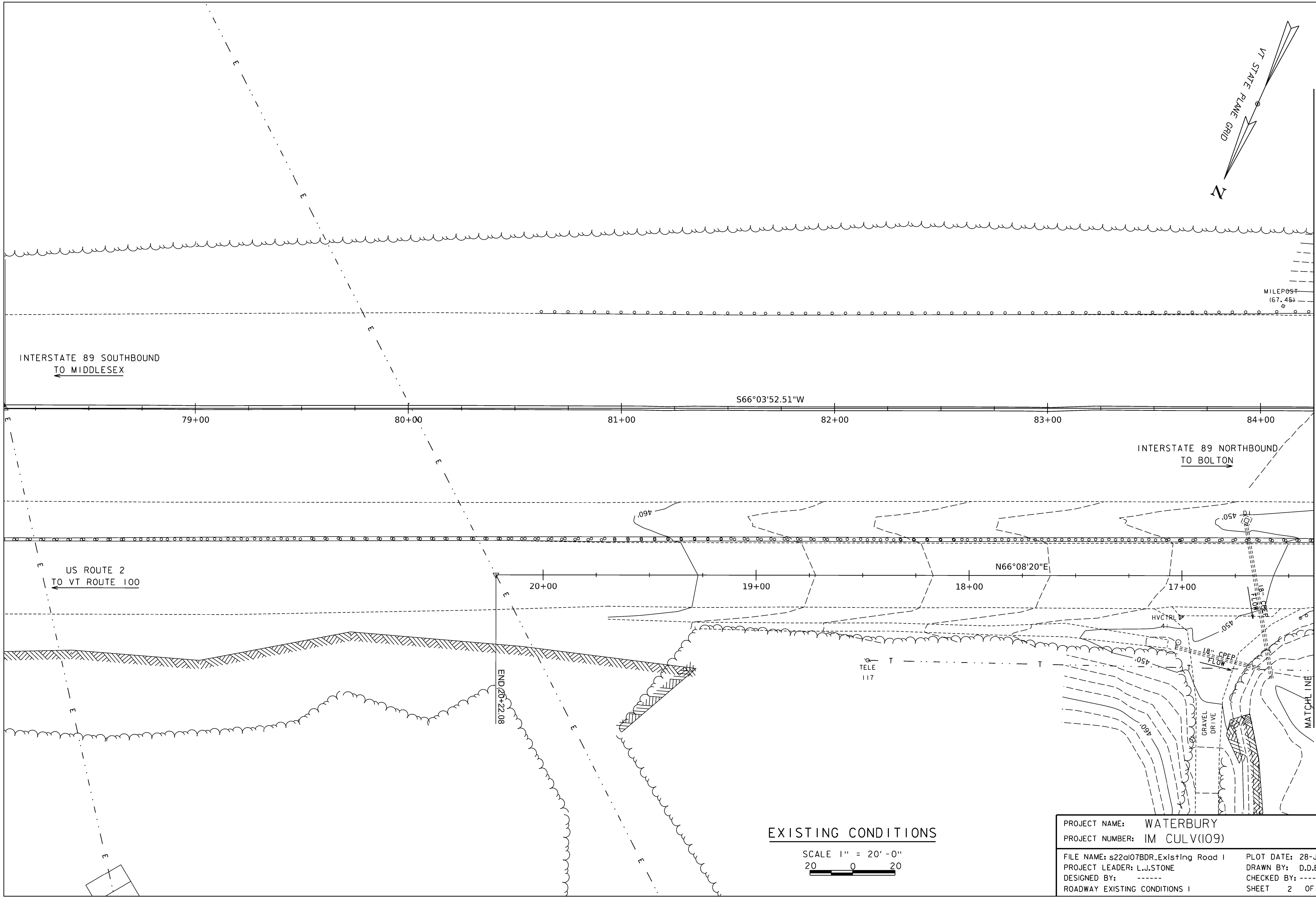

**EXISTING CONDITIONS**

SCALE 1" = 20' - 0"  
 20 0 20

PROJECT NAME:	WATERBURY	FILE NAME:	s22a107BDR.Existing Road 1	PLOT DATE:	28-JUN-2023
PROJECT NUMBER:	IM CULV(109)	PROJECT LEADER:	L.J.STONE	DRAWN BY:	D.D.BEARD
		DESIGNED BY:	-----	CHECKED BY:	-----
ROADWAY EXISTING CONDITIONS I				SHEET	2 OF 48

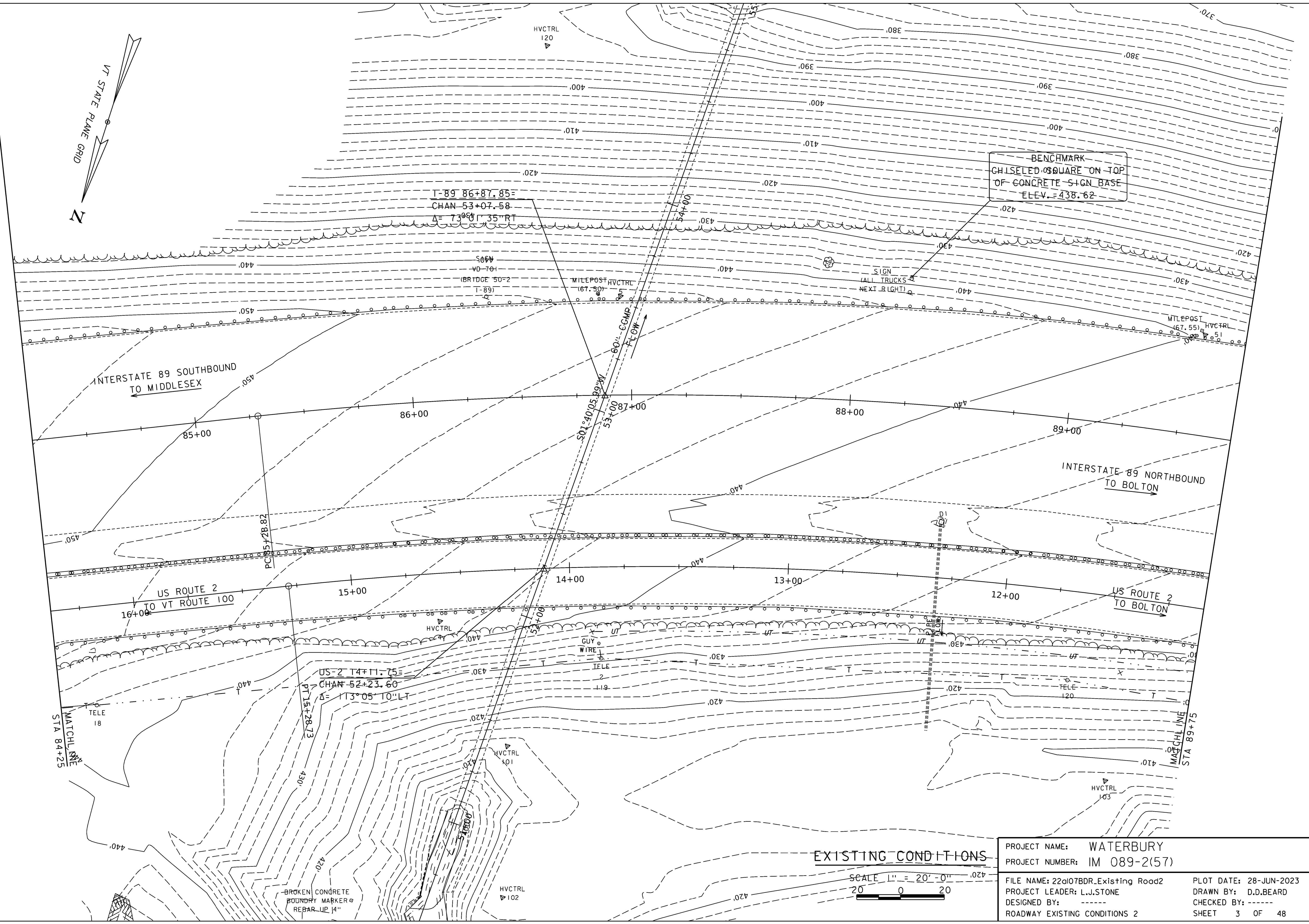
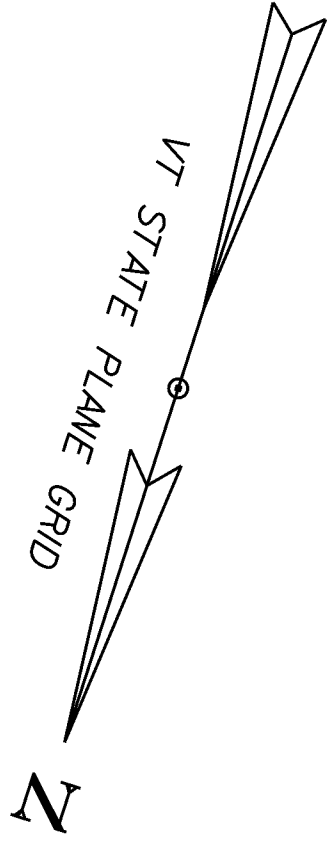

BENCHMARK  
CHISELED SQUARE ON TOP  
OF CONCRETE SIGN BASE  
ELEV. = 438.62

CHAN-53+07.58  
RT 1.35  
L 7.73  
Δ = 7

US-2 14+11.75  
CHAN-52+23.60  
L 1.01  
R 1.11  
Δ = 0.9

EXISTING CONDITIONS

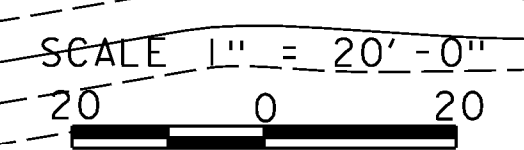

PROJECT NAME:	WATERBURY	PLOT DATE:	28-JUN-2023
PROJECT NUMBER:	IM 089-2(57)	DRAWN BY:	D.D.BEARD
FILE NAME:	22a107BDR.Existing Road2	CHECKED BY:	-----
PROJECT LEADER:	L.J.STONE	SHEET	3 OF 48
DESIGNED BY:	-----		
ROADWAY EXISTING CONDITIONS 2			

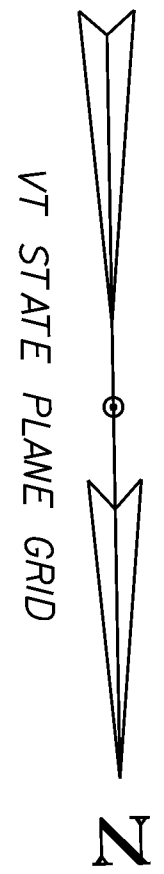

e = 201.98  
28.51

INTERSTATE 89 SOUTHBOUND  
TO MIDDLESEX

INTERSTATE 89 NORTHBOUND  
TO BOLTON

US ROUTE 2  
TO VT ROUTE 100

US ROUTE 2  
TO BOLTON

STA 89+75  
MATCHLINE

BENCHMARK  
RAILROAD SPIKE  
IN POLE  
ELEV. = 420.60

6xMAILBOXES  
SIGN  
D3-1  
(SHARKEYVILLE PVT)  
AER E&T

GRAVEL DRIVE

AER E&T

EXISTING CONDITIONS

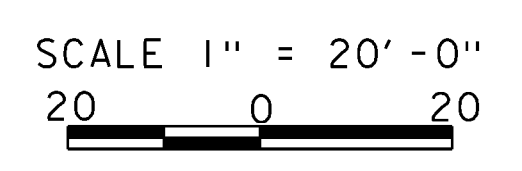

PROJECT NAME:	WATERBURY	FILE NAME:	s22a107BDR.Existing Road 3	PLOT DATE:	28-JUN-2023
PROJECT NUMBER:	IM CULV(109)	PROJECT LEADER:	L.J.STONE	DRAWN BY:	D.D.BEARD
		DESIGNED BY:	-----	CHECKED BY:	-----
		ROADWAY EXISTING CONDITIONS 3		SHEET	4 OF 48

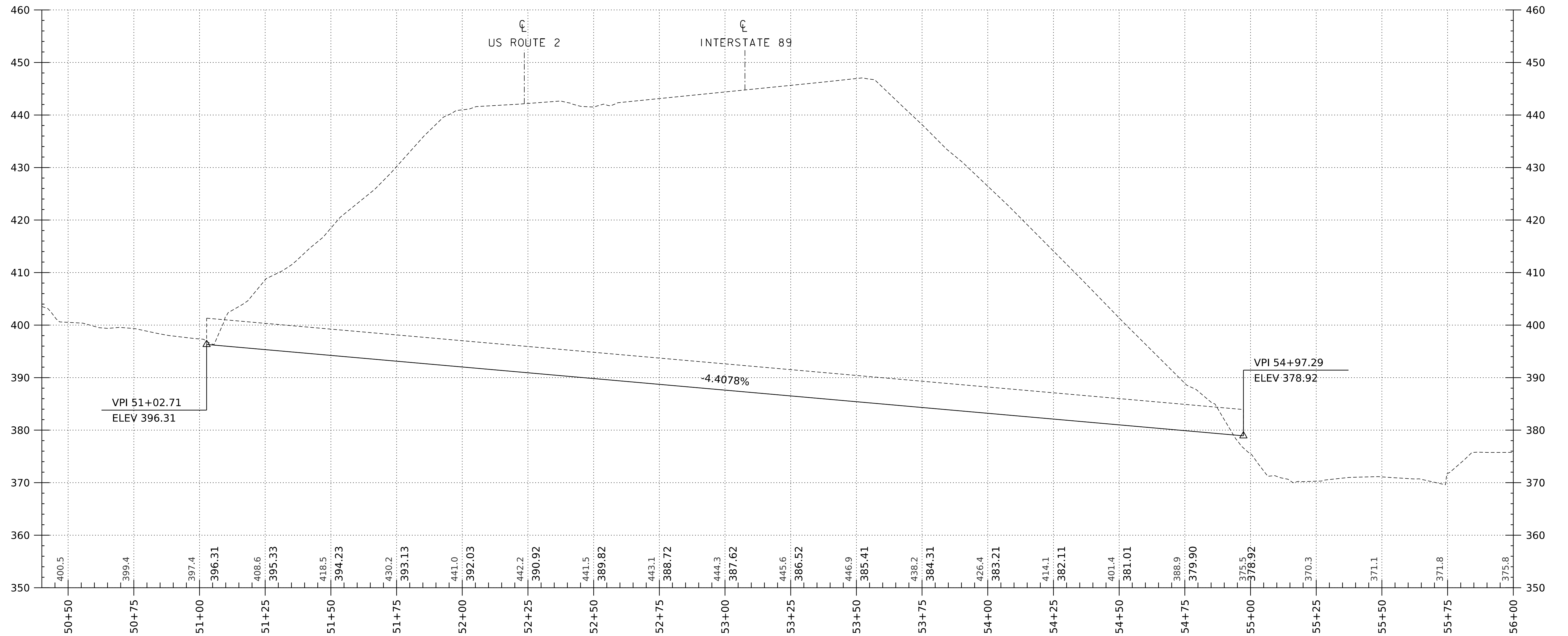

**EXISTING CULVERT PROFILE**

SCALE: HORIZONTAL 1"=20'-0"  
 VERTICAL 1"=10'-0"

NOTE:  
 GRADES SHOWN TO THE NEAREST TENTH ARE EXISTING GROUND ALONG  $\phi$   
 GRADES SHOWN TO THE NEAREST HUNDREDTH ARE FINISH GRADE ALONG  $\phi$

PROJECT NAME: WATERBURY	
PROJECT NUMBER: IM CULV(109)	
FILE NAME: s22a107profile.dgn	PLOT DATE: 28-JUN-2023
PROJECT LEADER: L.J.STONE	DRAWN BY: D.D.BEARD
DESIGNED BY: -----	CHECKED BY: -----
EXISTING CULVERT PROFILE SHEET	SHEET 5 OF 48

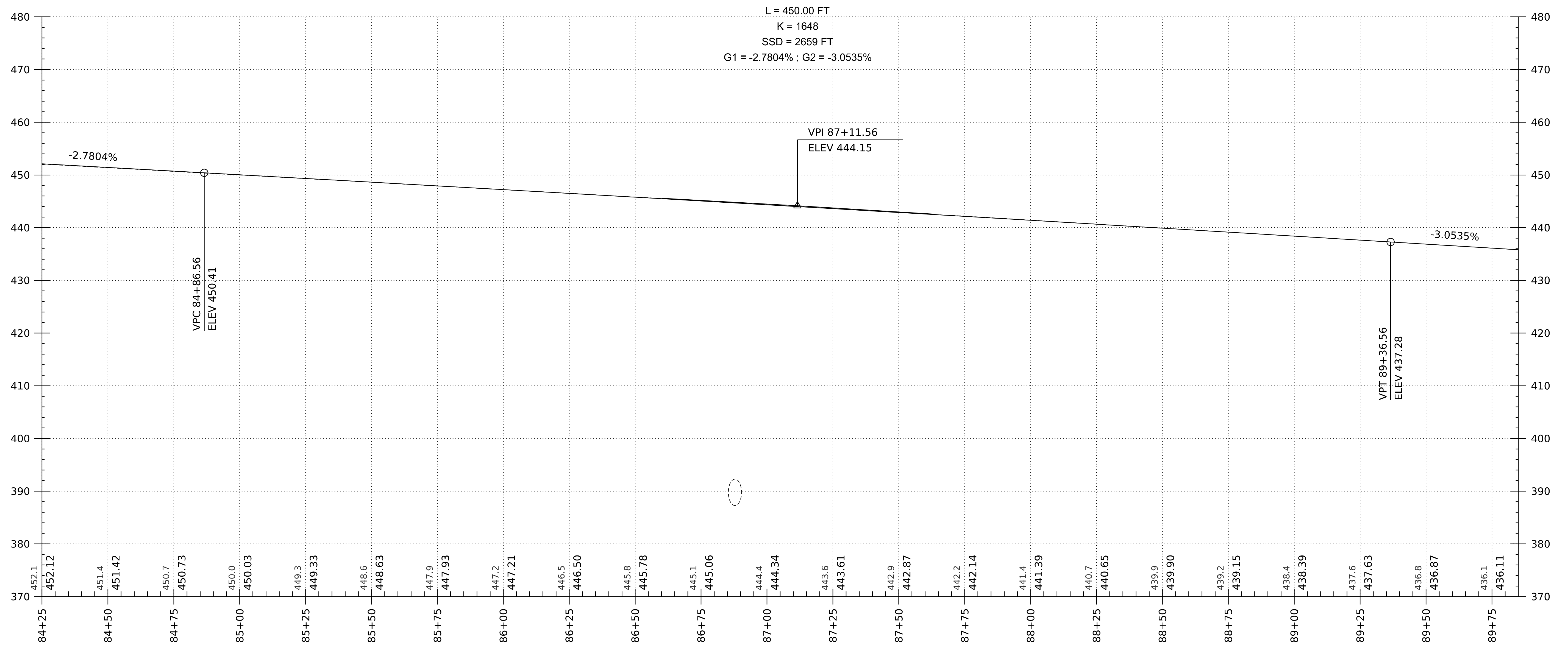

INTERSTATE 89 EXISTING PROFILE

SCALE: HORIZONTAL 1"=20'-0"  
 VERTICAL 1"=10'-0"

NOTE:  
 GRADES SHOWN TO THE NEAREST  
 TENTH ARE EXISTING GROUND ALONG  $\phi$   
 GRADES SHOWN TO THE NEAREST  
 HUNDREDTH ARE FINISH GRADE ALONG  $\phi$

PROJECT NAME: WATERBURY	
PROJECT NUMBER: IM CULV(109)	
FILE NAME: s22a107profile.dgn	PLOT DATE: 28-JUN-2023
PROJECT LEADER: L.J.STONE	DRAWN BY: D.D.BEARD
DESIGNED BY: -----	CHECKED BY: -----
INTERSTATE 89 EXISTING PROFILE SHEET	SHEET 6 OF 48

L = 600.00 FT  
 K = 1112  
 HSSD = INF FT  
 G1 = 3.1258% ; G2 = 3.6652%

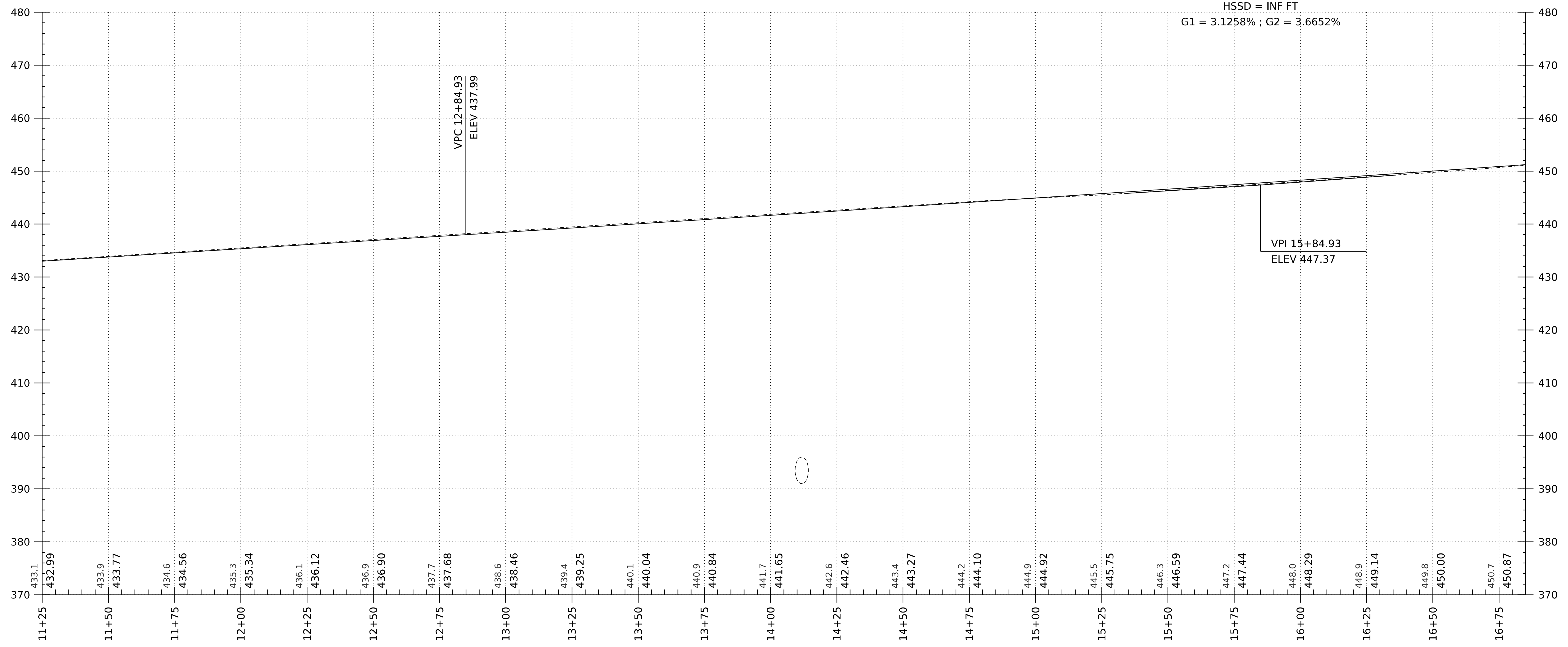

US ROUTE 2 EXISTING PROFILE

SCALE: HORIZONTAL 1"=20'-0"  
 VERTICAL 1"=10'-0"

NOTE:  
 GRADES SHOWN TO THE NEAREST TENTH ARE EXISTING GROUND ALONG  $\phi$   
 GRADES SHOWN TO THE NEAREST HUNDREDTH ARE FINISH GRADE ALONG  $\phi$

PROJECT NAME:	WATERBURY
PROJECT NUMBER:	IM CULV(109)
FILE NAME:	s22a107profile.dgn
PROJECT LEADER:	L.J.STONE
DESIGNED BY:	-----
US ROUTE 2 EXISTING PROFILE SHEET	
PLOT DATE:	28-JUN-2023
DRAWN BY:	D.D.BEARD
CHECKED BY:	-----
SHEET	7 OF 48

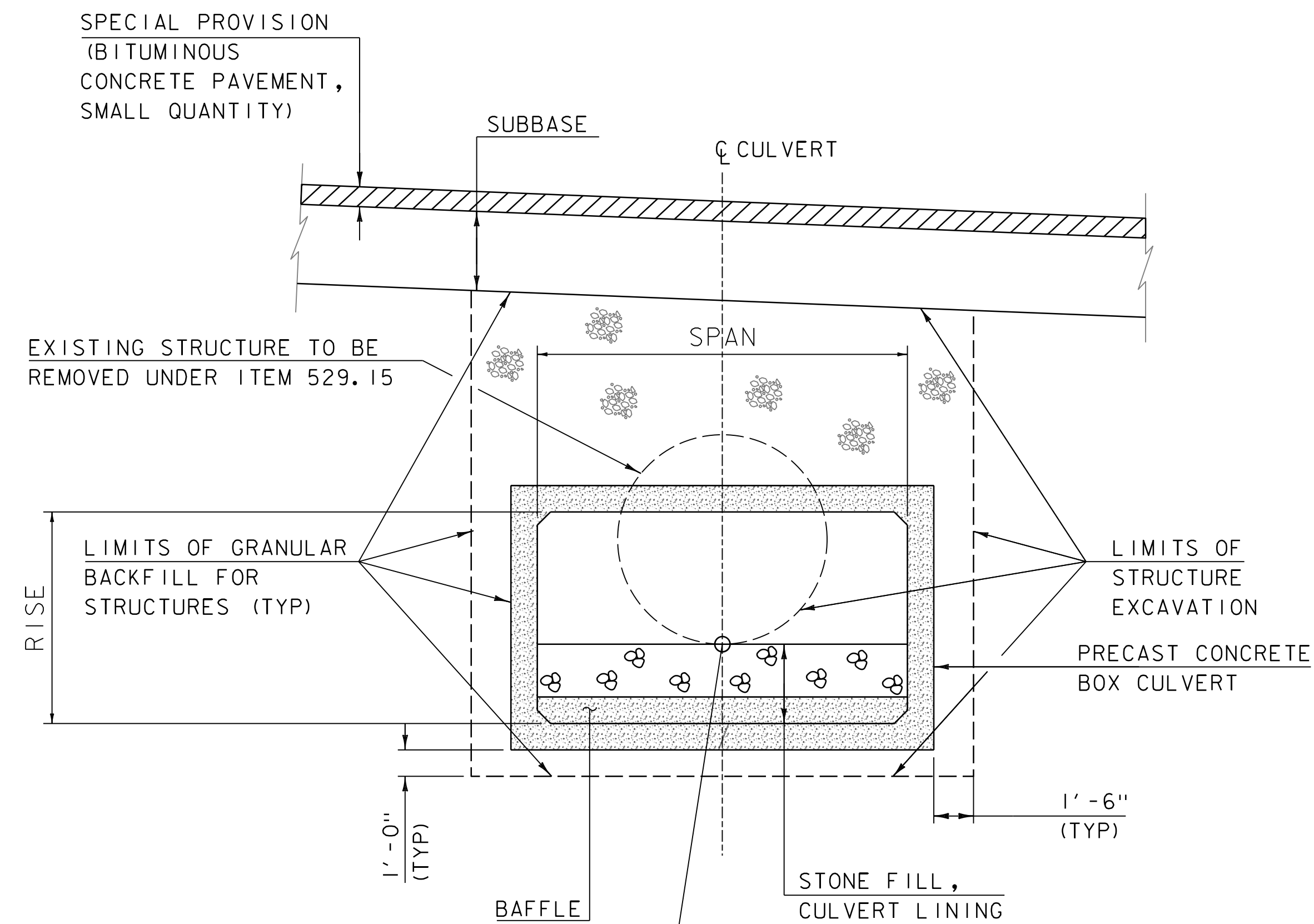

SPAN	18' - 0"
RISE	11' - 0"
LENGTH	360' - 0"

**CULVERT TYPICAL SECTION**

NOT TO SCALE

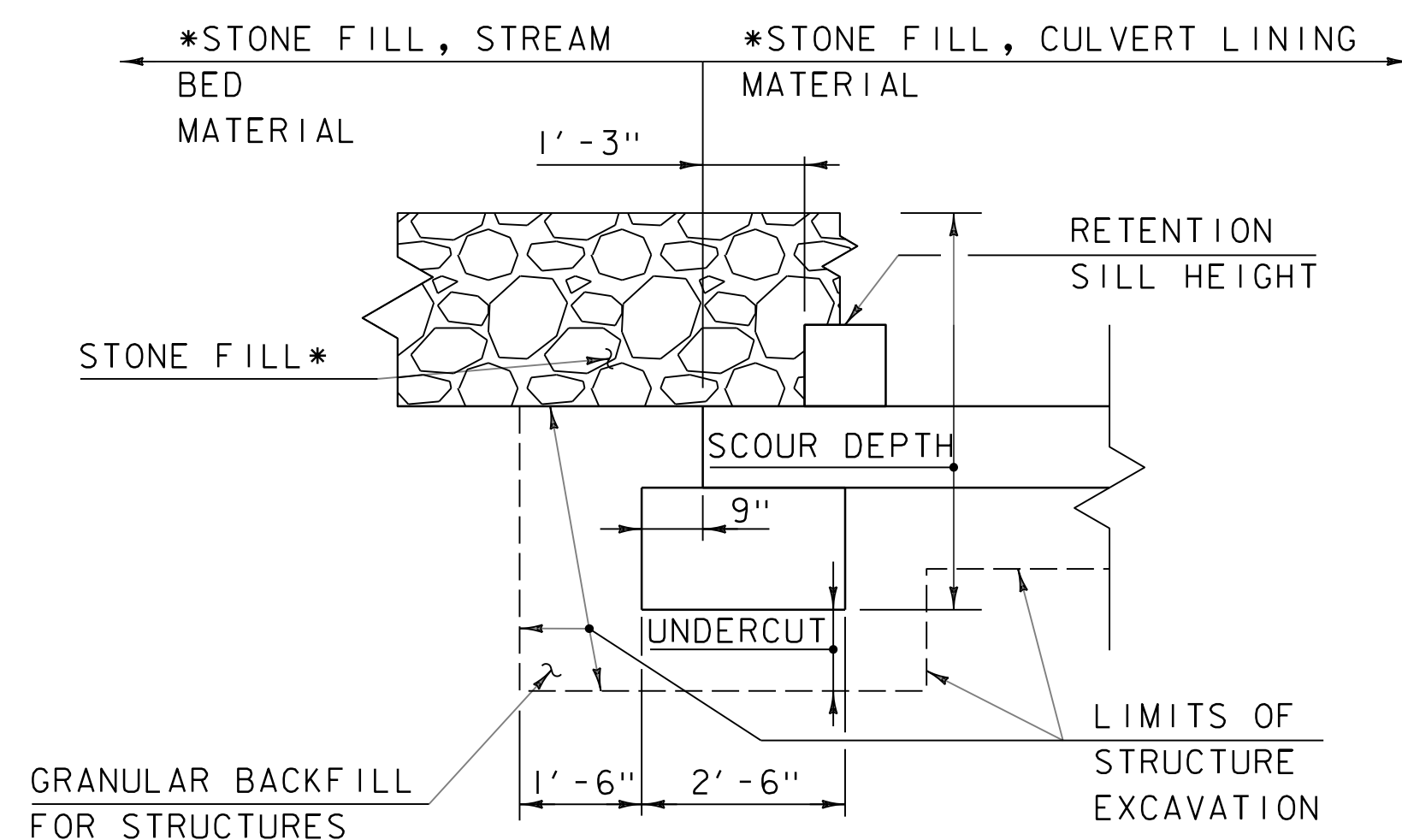

**CUTOFF WALL TYPICAL SECTION**

NOT TO SCALE

NOTE:

THE CUTOFF WALL MAY BE OMITTED IF THE DEPTH OF CULVERT LINING MATERIAL PLUS THE THICKNESS TO THE BOTTOM OF THE BOX MEETS OR EXCEEDS THE LISTED SCOUR DEPTH.

**CUTOFF WALL - CRITICAL DIMENSIONS**

	DIMENSION
SCOUR DEPTH	4' - 0"
RETENTION SILL HEIGHT	1' - 0"
UNDERCUT	1' - 0"

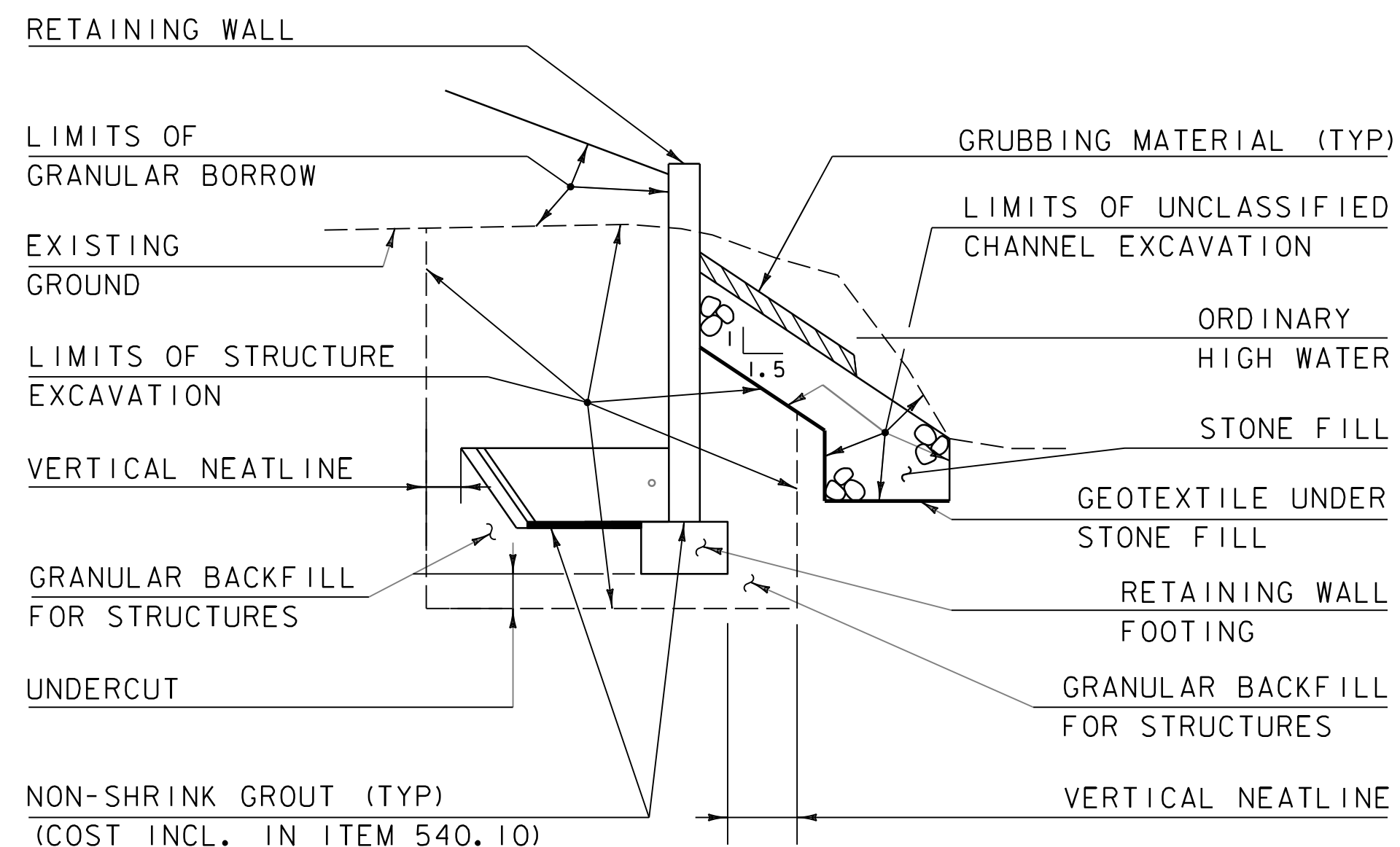

**RETAINING WALL EARTHWORK TYPICAL SECTION**

NOT TO SCALE

NOTE:

TOP OF RETAINING WALL FOOTING SHALL BE AT OR BELOW BOTTOM OF BOX CULVERT.

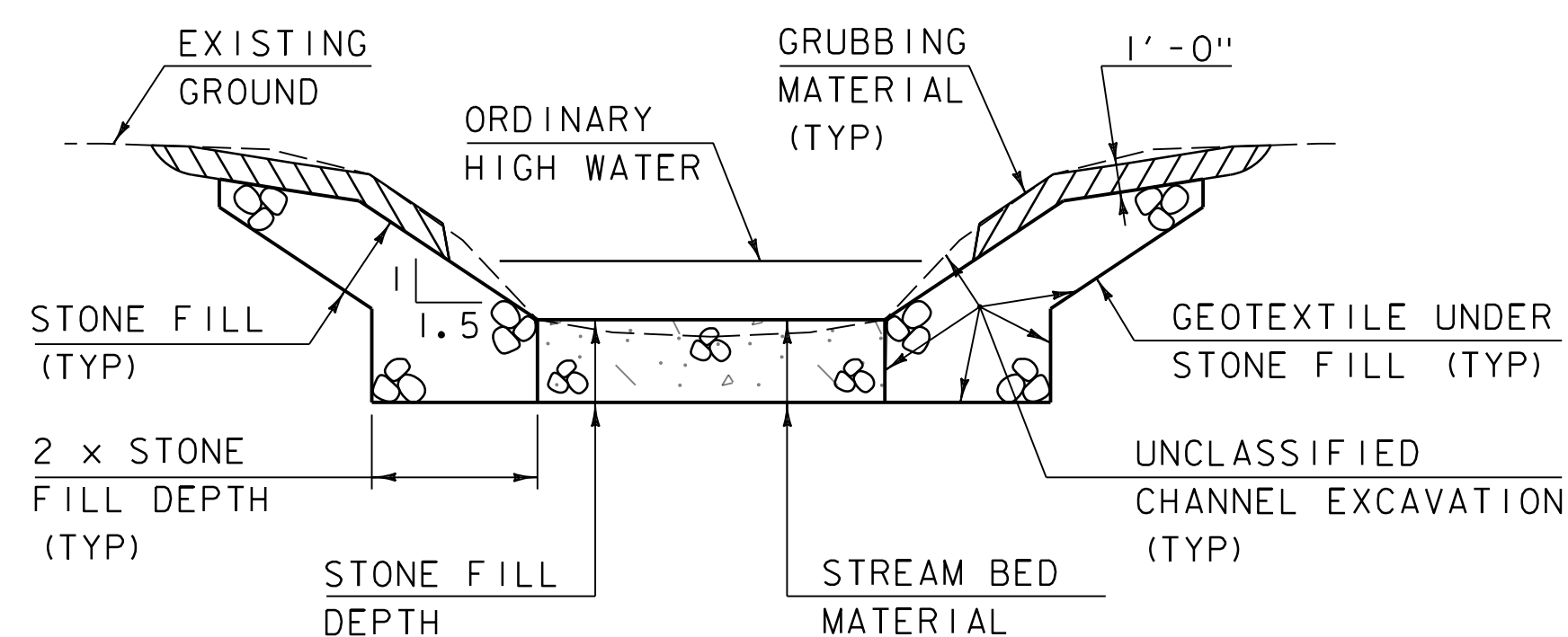

**TYPICAL CHANNEL SECTION**

(NOT TO SCALE)

- 1) WHENEVER CHANNEL SLOPE INTERSECTS ROADWAY SUBBASE, GRUBBING MATERIAL SHALL BEGIN AT THE BOTTOM OF SUBBASE.
- 2) THE CONTRACTOR SHALL CREATE A LOW FLOW CHANNEL IN THE STREAM BED MATERIAL AS DIRECTED BY THE ENGINEER.
- 3) GRUBBING MATERIAL SHALL BE PLACED UNDERNEATH STRUCTURES WHERE THERE IS MORE THAN 6 FEET VERTICALLY FROM ORDINARY HIGH WATER (OHW) TO THE BOTTOM OF SUPERSTRUCTURE AND MORE THAN 6 FEET HORIZONTALLY FROM OHW LINE TO FRONT FACE OF ABUTMENT. THIS MATERIAL SHALL START JUST ABOVE THE OHW ELEVATION AND TERMINATE 3 FEET HORIZONTALLY FROM THE FRONT FACE OF THE ABUTMENT. THIS MATERIAL SHALL NOT BE PLACED UNDERNEATH DOWNSPOUTS. SEE THE CHANNEL SECTIONS FOR ADDITIONAL DETAILING.

**MATERIAL INFORMATION**

	THICKNESS	TYPE
STONE FILL	3' - 0"	TYPE III
STONE FILL, CULVERT LINING	3' - 0"	E-STONE TYPE III
STONE FILL, STREAM BED MATERIAL	3' - 0"	E-STONE TYPE III

**RETAINING WALL - ASSUMED DIMENSIONS**

LEVELING PAD	
WIDTH	DIMENSION
WIDTH	2' - 6"
TOE	0' - 9"
HEEL	0' - 9"
THICKNESS	1' - 0"
UNDERCUT	1' - 0"
WALL	
THICKNESS	1' - 0"
HEIGHT	VARIES
EXCAVATION LIMITS	
VERTICAL NEATLINE	1' - 6"
UNDERCUT	1' - 0"

PROJECT NAME: WATERBURY  
PROJECT NUMBER: IM CULV(109)

FILE NAME: 22d107/s22d107typ.dgn PLOT DATE: 28-JUN-2023  
PROJECT LEADER: L.J.STONE DRAWN BY: D.D.BEARD  
DESIGNED BY: ----- CHECKED BY: -----  
PRECAST CULVERT TYPICAL SECTIONS SHEET 8 OF 48



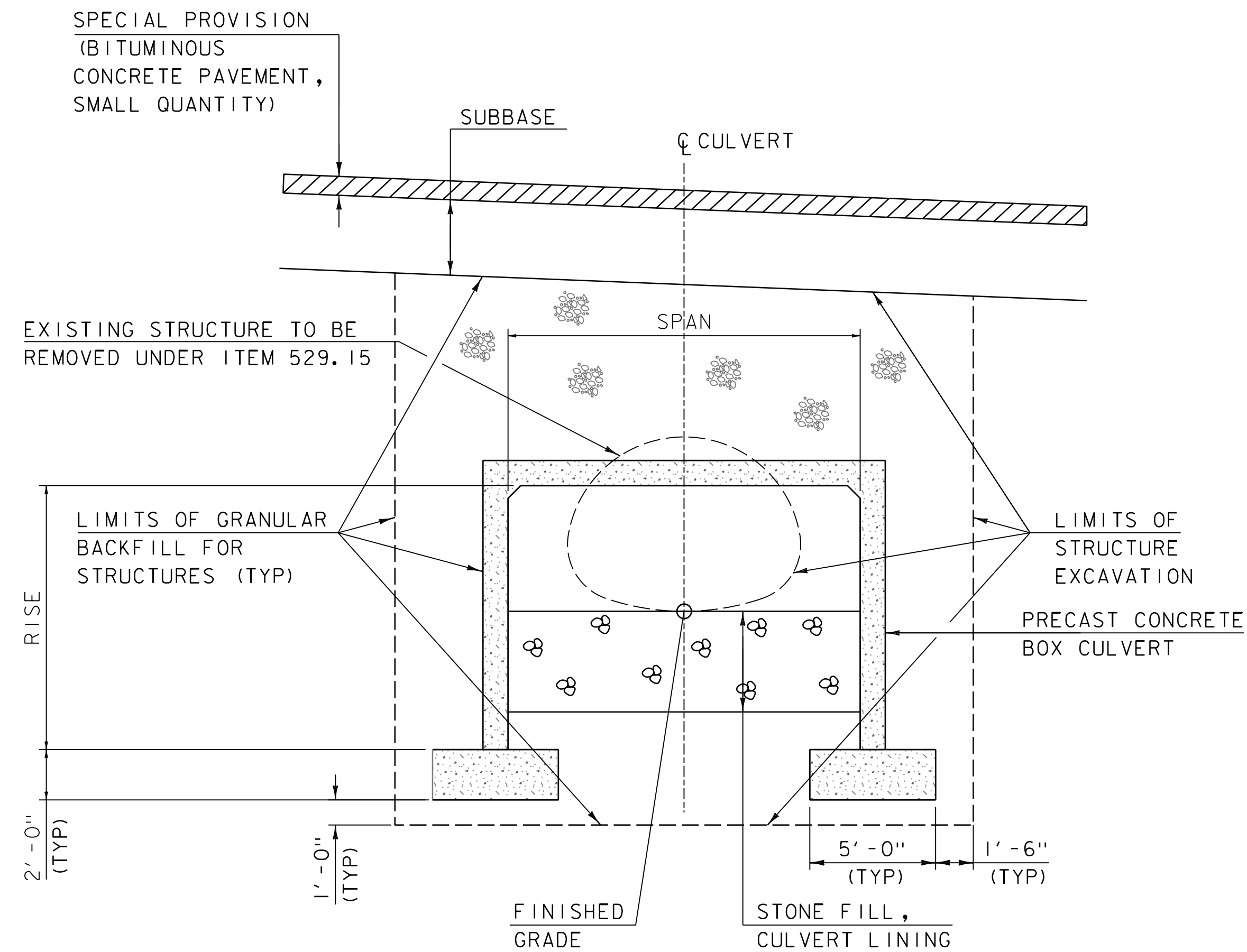

SPAN	18' - 0"
RISE	14' - 0"
LENGTH	360' - 0"

**CULVERT TYPICAL SECTION**

NOT TO SCALE

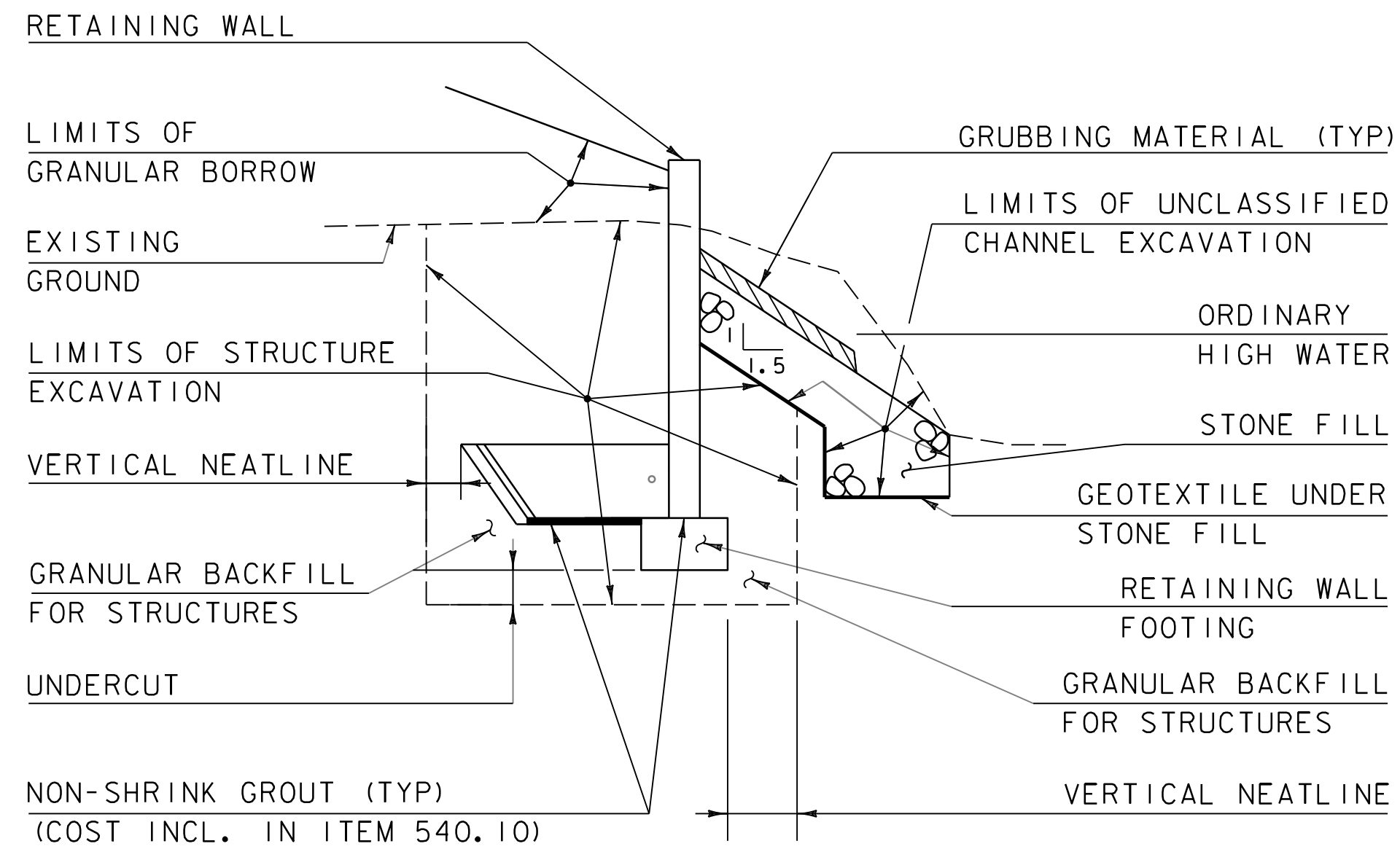

**RETAINING WALL EARTHWORK TYPICAL SECTION**

NOT TO SCALE

NOTE:

TOP OF RETAINING WALL FOOTING SHALL BE AT OR BELOW BOTTOM OF BOX CULVERT.

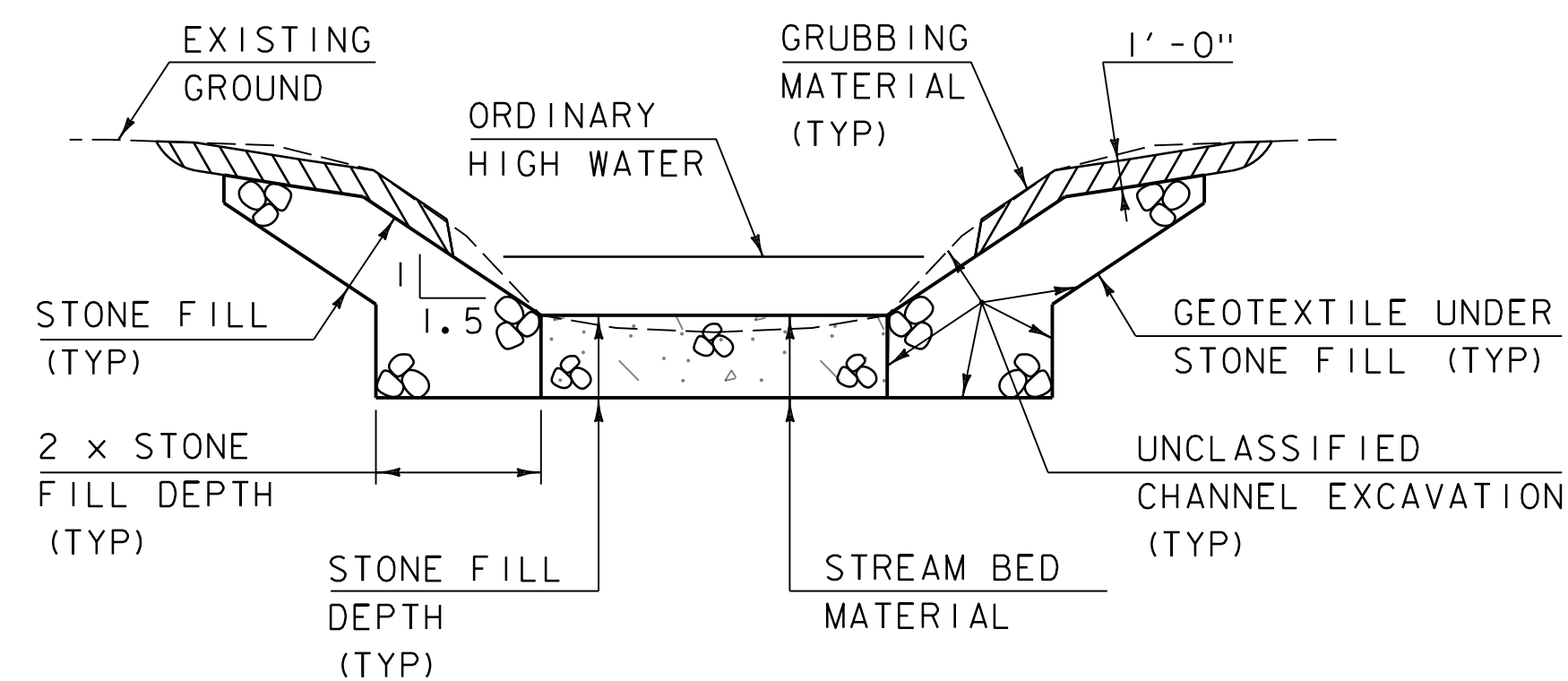

**TYPICAL CHANNEL SECTION**

(NOT TO SCALE)

- 1) WHENEVER CHANNEL SLOPE INTERSECTS ROADWAY SUBBASE, GRUBBING MATERIAL SHALL BEGIN AT THE BOTTOM OF SUBBASE.
- 2) THE CONTRACTOR SHALL CREATE A LOW FLOW CHANNEL IN THE STREAM BED MATERIAL AS DIRECTED BY THE ENGINEER.
- 3) GRUBBING MATERIAL SHALL BE PLACED UNDERNEATH STRUCTURES WHERE THERE IS MORE THAN 6 FEET VERTICALLY FROM ORDINARY HIGH WATER (OHW) TO THE BOTTOM OF SUPERSTRUCTURE AND MORE THAN 6 FEET HORIZONTALLY FROM OHW LINE TO FRONT FACE OF ABUTMENT. THIS MATERIAL SHALL START JUST ABOVE THE OHW ELEVATION AND TERMINATE 3 FEET HORIZONTALLY FROM THE FRONT FACE OF THE ABUTMENT. THIS MATERIAL SHALL NOT BE PLACED UNDERNEATH DOWNSPOUTS. SEE THE CHANNEL SECTIONS FOR ADDITIONAL DETAILING.

**MATERIAL INFORMATION**

	THICKNESS	TYPE
STONE FILL	3'-0"	TYPE III
STONE FILL, CULVERT LINING	3'-0"	E-STONE TYPE III
STONE FILL, STREAM BED MATERIAL	3'-0"	E-STONE TYPE III

**RETAINING WALL - ASSUMED DIMENSIONS**

LEVELING PAD	
WIDTH	DIMENSION
WIDTH	2' - 6"
TOE	0' - 9"
HEEL	0' - 9"
THICKNESS	1' - 0"
UNDERCUT	1' - 0"
WALL	
THICKNESS	1' - 0"
HEIGHT	VARIES
EXCAVATION LIMITS	
VERTICAL NEATLINE	1' - 6"
UNDERCUT	1' - 0"

PROJECT NAME: WATERBURY  
PROJECT NUMBER: IM CULV(109)

FILE NAME: 22cl07/s22cl07typ.dgn  
PROJECT LEADER: L.J.STONE  
DESIGNED BY: -----  
3-SIDED FRAME TYPICAL SECTIONS

PLOT DATE: 28-JUN-2023  
DRAWN BY: D.D.BEARD  
CHECKED BY: -----  
SHEET 9 OF 48

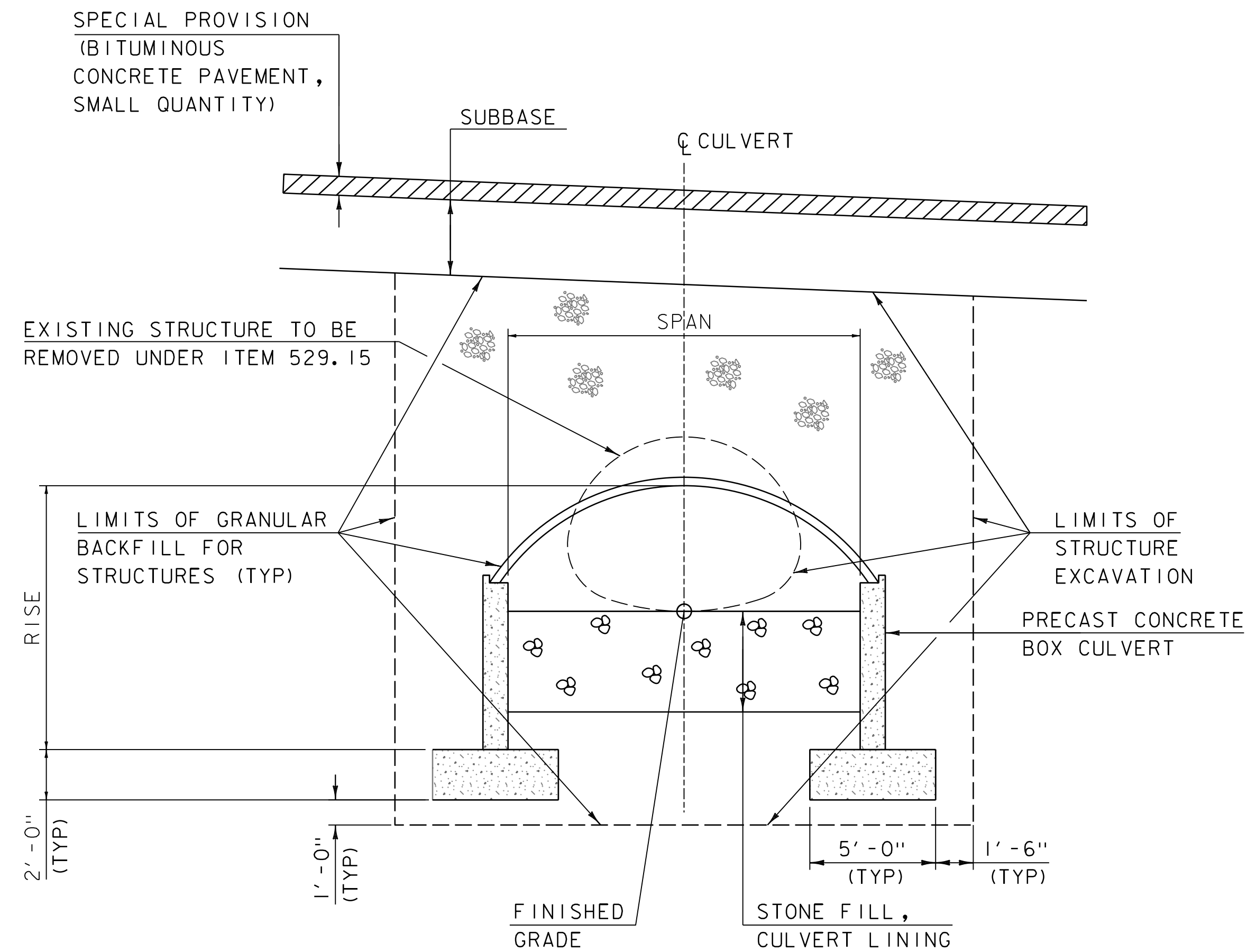

SPAN	102' - 0"
RISE	13' - 8"
LENGTH	200' - 0"

**CULVERT TYPICAL SECTION**

NOT TO SCALE

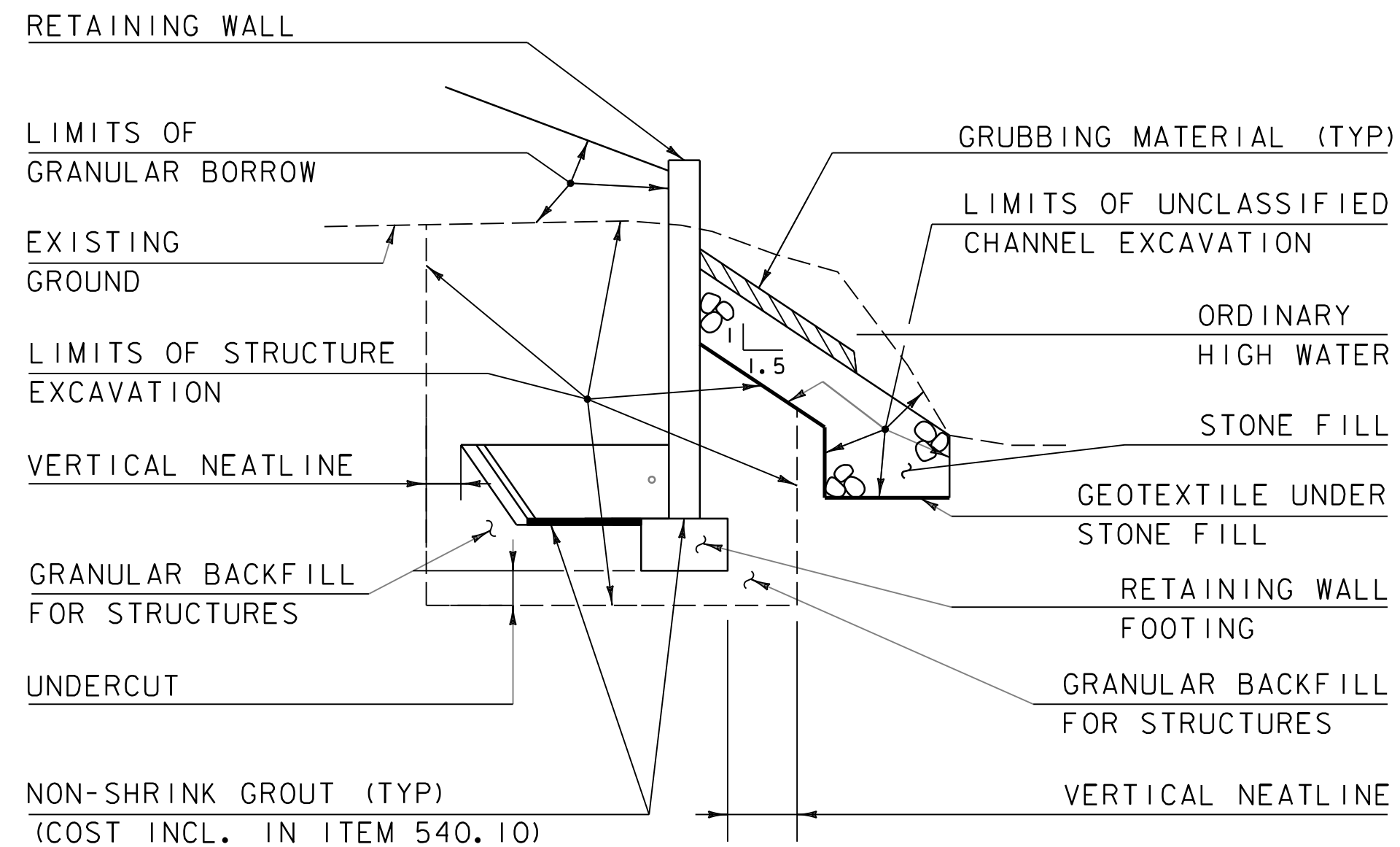

**RETAINING WALL EARTHWORK TYPICAL SECTION**

NOT TO SCALE

NOTE:

TOP OF RETAINING WALL FOOTING SHALL BE AT OR BELOW BOTTOM OF BOX CULVERT.

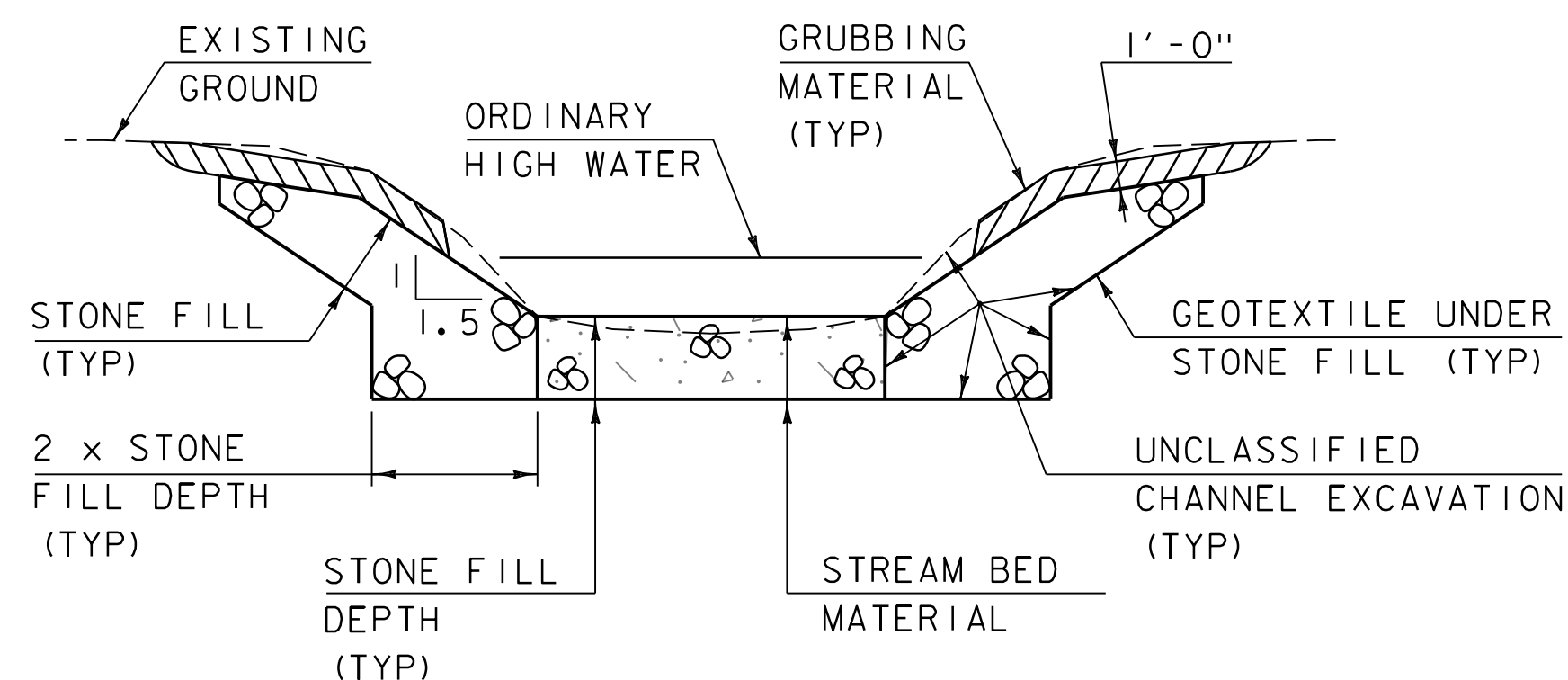

**TYPICAL CHANNEL SECTION**

(NOT TO SCALE)

- 1) WHENEVER CHANNEL SLOPE INTERSECTS ROADWAY SUBBASE, GRUBBING MATERIAL SHALL BEGIN AT THE BOTTOM OF SUBBASE.
- 2) THE CONTRACTOR SHALL CREATE A LOW FLOW CHANNEL IN THE STREAM BED MATERIAL AS DIRECTED BY THE ENGINEER.
- 3) GRUBBING MATERIAL SHALL BE PLACED UNDERNEATH STRUCTURES WHERE THERE IS MORE THAN 6 FEET VERTICALLY FROM ORDINARY HIGH WATER (OHW) TO THE BOTTOM OF SUPERSTRUCTURE AND MORE THAN 6 FEET HORIZONTALLY FROM OHW LINE TO FRONT FACE OF ABUTMENT. THIS MATERIAL SHALL START JUST ABOVE THE OHW ELEVATION AND TERMINATE 3 FEET HORIZONTALLY FROM THE FRONT FACE OF THE ABUTMENT. THIS MATERIAL SHALL NOT BE PLACED UNDERNEATH DOWNSPOUTS. SEE THE CHANNEL SECTIONS FOR ADDITIONAL DETAILING.

**MATERIAL INFORMATION**

	THICKNESS	TYPE
STONE FILL	3'-0"	TYPE III
STONE FILL, CULVERT LINING	3'-0"	E-STONE TYPE III
STONE FILL, STREAM BED MATERIAL	3'-0"	E-STONE TYPE III

**RETAINING WALL - ASSUMED DIMENSIONS**

LEVELING PAD	
WIDTH	DIMENSION
WIDTH	2' - 6"
TOE	0' - 9"
HEEL	0' - 9"
THICKNESS	1' - 0"
UNDERCUT	1' - 0"
WALL	
THICKNESS	1' - 0"
HEIGHT	VARIES
EXCAVATION LIMITS	
VERTICAL NEATLINE	1' - 6"
UNDERCUT	1' - 0"

PROJECT NAME: WATERBURY  
PROJECT NUMBER: IM CULV(109)

FILE NAME: 22d107/s22d107typ.dgn  
PROJECT LEADER: L.J.STONE  
DESIGNED BY: -----  
PIPE ARCH TYPICAL SECTIONS

PLOT DATE: 28-JUN-2023  
DRAWN BY: D.D.BEARD  
CHECKED BY: -----  
SHEET 10 OF 48

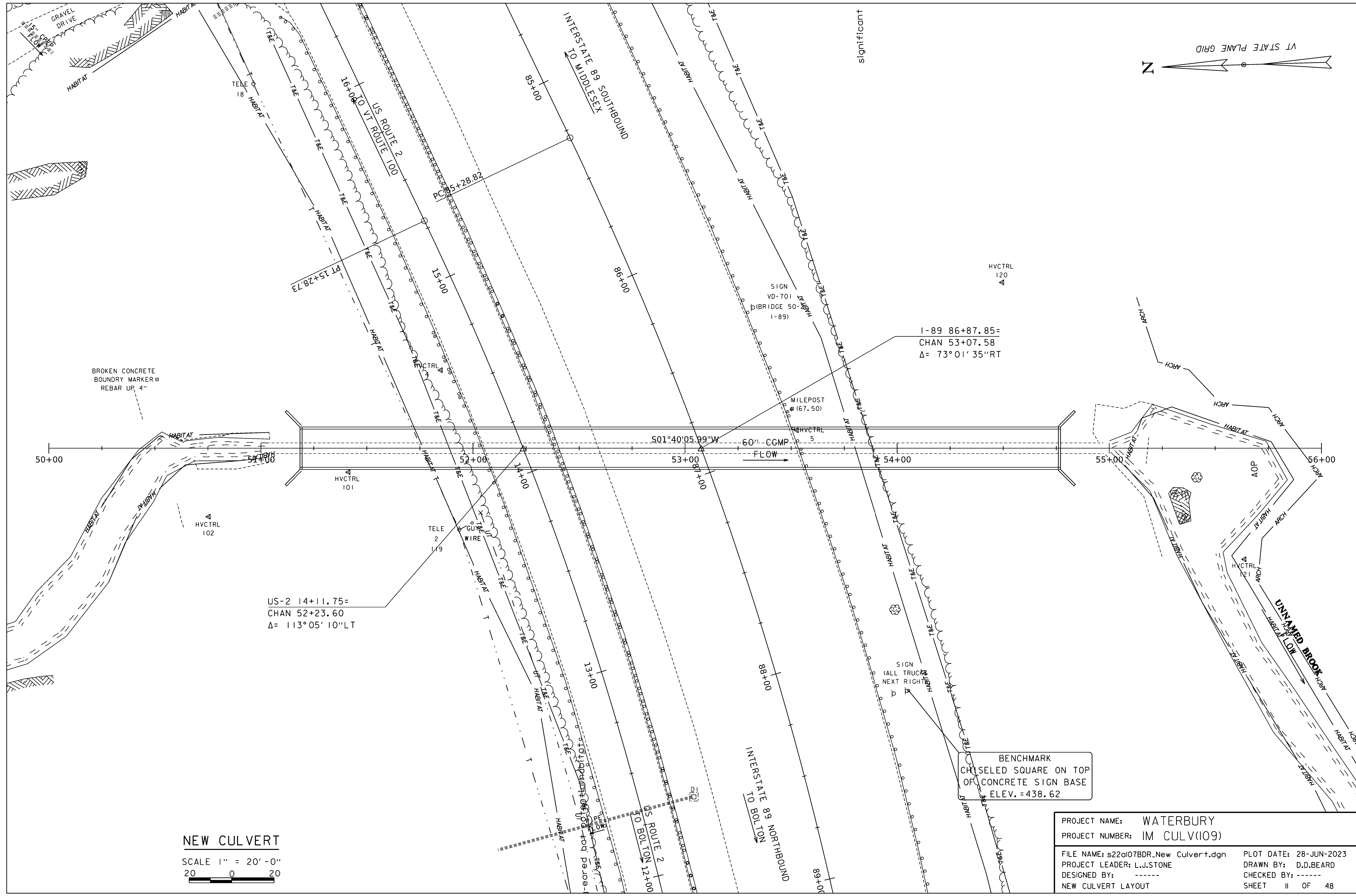
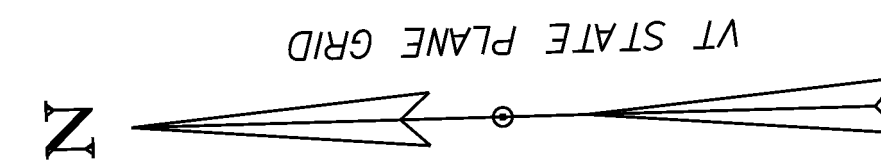

I-89 86+87.85=  
CHAN 53+07.58  
Δ= 73°01'35"RT

US-2 14+11.75=  
CHAN 52+23.60  
Δ= 113°05'10"LT

BENCHMARK  
CHISELED SQUARE ON TOP  
OF CONCRETE SIGN BASE  
ELEV. = 438.62

**NEW CULVERT**  
SCALE 1" = 20'-0"  
20 0 20

PROJECT NAME:	WATERBURY		
PROJECT NUMBER:	IM CULV(109)		
FILE NAME:	s22a107BDR_New Culvert.dgn	PLOT DATE:	28-JUN-2023
PROJECT LEADER:	L.J.STONE	DRAWN BY:	D.D.BEARD
DESIGNED BY:	-----	CHECKED BY:	-----
NEW CULVERT LAYOUT		SHEET	II OF 48

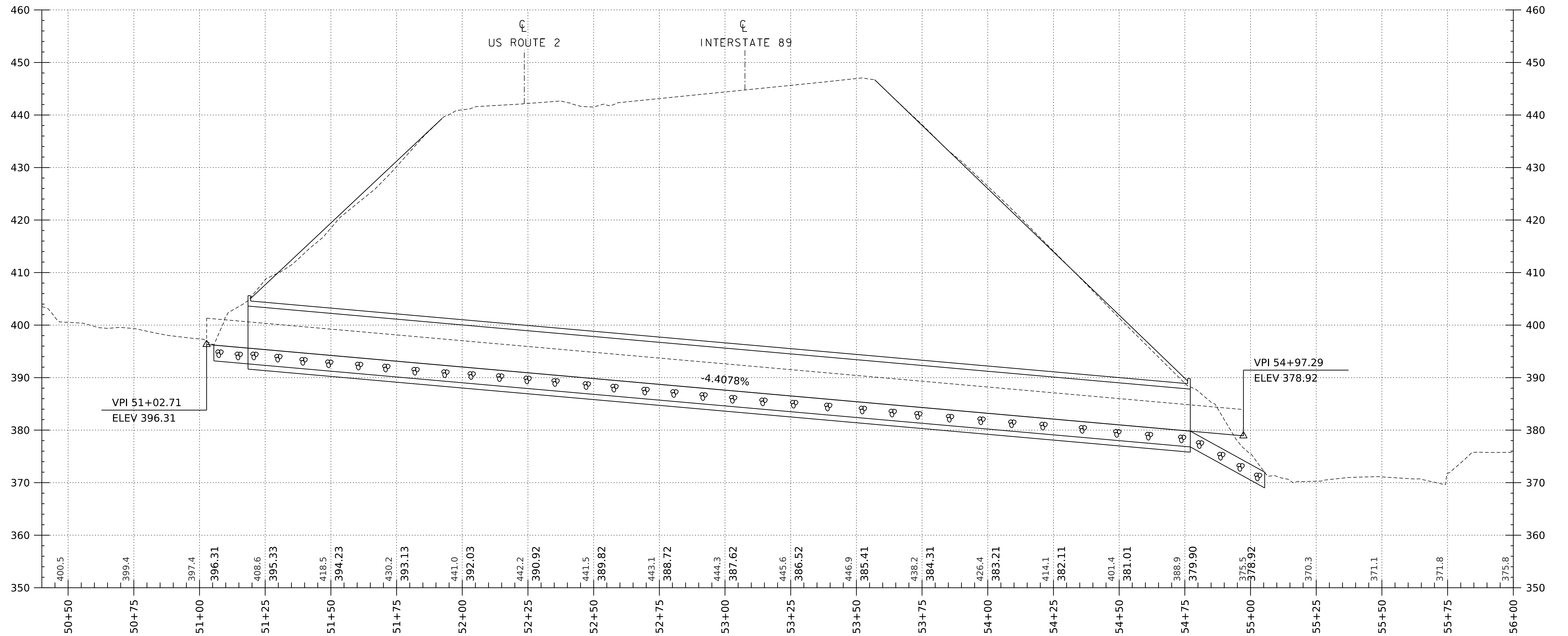

**NEW BOX CULVERT PROFILE**

SCALE: HORIZONTAL 1"=20'-0"  
 VERTICAL 1"=10'-0"

NOTE:  
 GRADES SHOWN TO THE NEAREST TENTH ARE EXISTING GROUND ALONG  $\phi$   
 GRADES SHOWN TO THE NEAREST HUNDREDTH ARE FINISH GRADE ALONG  $\phi$

PROJECT NAME: WATERBURY	
PROJECT NUMBER: IM CULV(109)	
FILE NAME: s22a107profile.dgn	PLOT DATE: 28-JUN-2023
PROJECT LEADER: L.J.STONE	DRAWN BY: D.D.BEARD
DESIGNED BY: -----	CHECKED BY: -----
NEW BOX CULVERT PROFILE SHEET	SHEET 12 OF 48

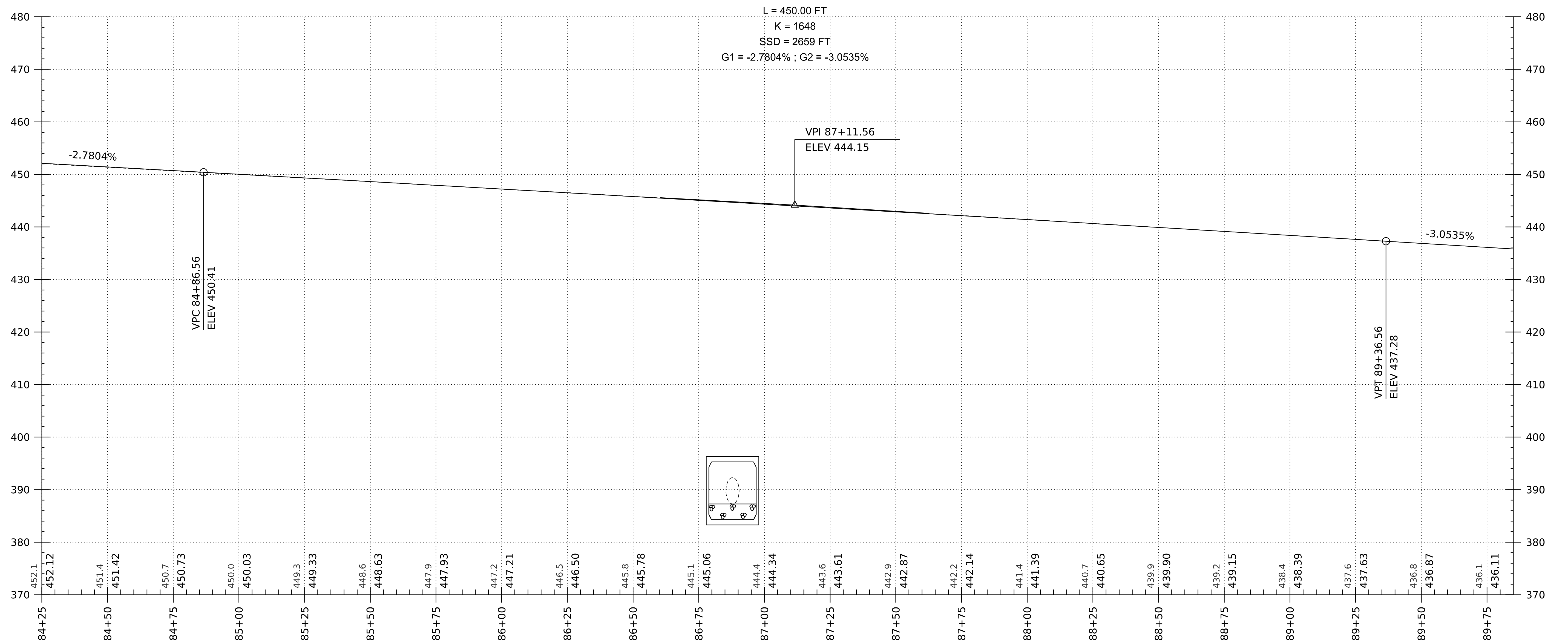

INTERSTATE 89 BOX CULVERT PROFILE

SCALE: HORIZONTAL 1"=20'-0"  
 VERTICAL 1"=10'-0"

NOTE:  
 GRADES SHOWN TO THE NEAREST  
 TENTH ARE EXISTING GROUND ALONG  $\phi$   
 GRADES SHOWN TO THE NEAREST  
 HUNDREDTH ARE FINISH GRADE ALONG  $\phi$

PROJECT NAME:	WATERBURY
PROJECT NUMBER:	IM CULV(109)
FILE NAME:	s22a107profile.dgn
PROJECT LEADER:	L.J.STONE
DESIGNED BY:	-----
INTERSTATE 89 BOX CULVERT PROFILE SHEET	SHEET 13 OF 48
PLOT DATE:	28-JUN-2023
DRAWN BY:	D.D.BEARD
CHECKED BY:	-----

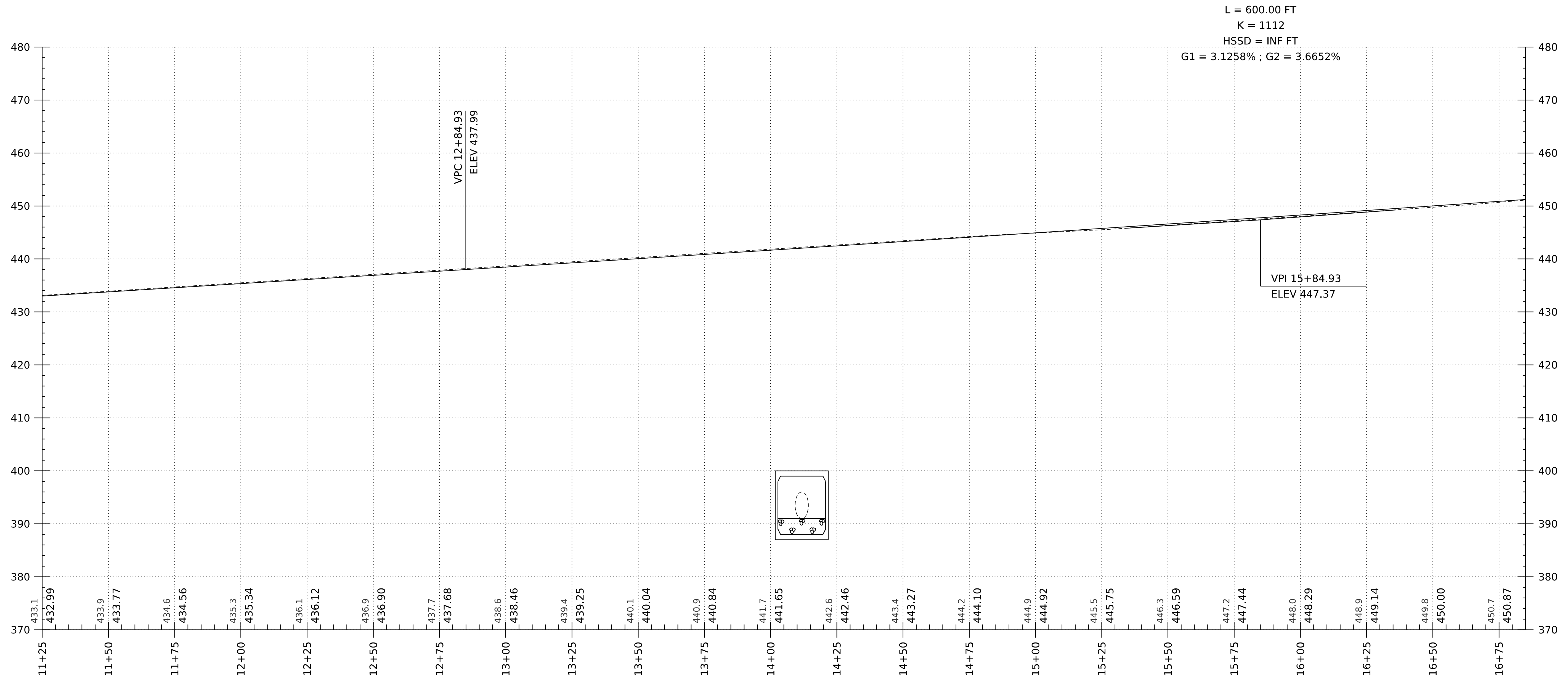

US ROUTE 2 BOX CULVERT PROFILE

SCALE: HORIZONTAL 1"=20'-0"  
 VERTICAL 1"=10'-0"

NOTE:  
 GRADES SHOWN TO THE NEAREST TENTH ARE EXISTING GROUND ALONG  $\phi$   
 GRADES SHOWN TO THE NEAREST HUNDREDTH ARE FINISH GRADE ALONG  $\phi$

PROJECT NAME:	WATERBURY
PROJECT NUMBER:	IM CULV(109)
FILE NAME:	s22a107profile.dgn
PROJECT LEADER:	L.J.STONE
DESIGNED BY:	-----
US ROUTE 2 BOX CULVERT PROFILE SHEET	
PLOT DATE:	28-JUN-2023
DRAWN BY:	D.D.BEARD
CHECKED BY:	-----
SHEET	14 OF 48

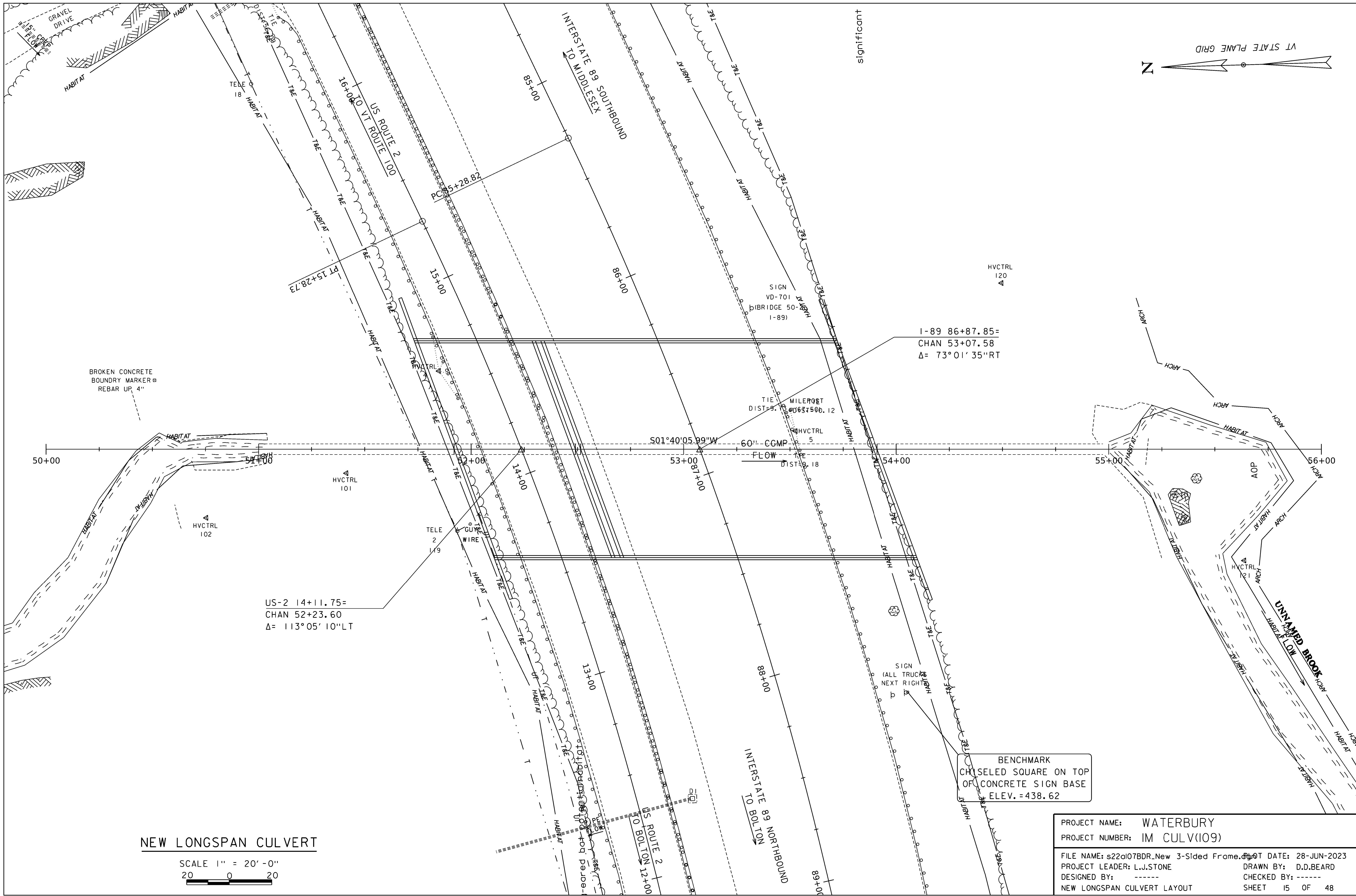
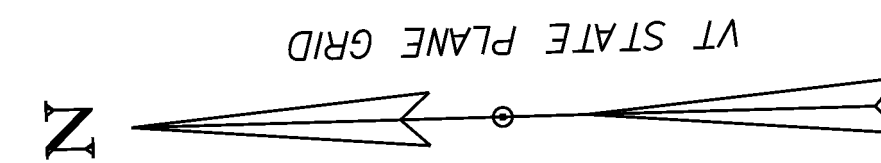

**NEW LONGSPAN CULVERT**

SCALE 1" = 20'-0"

PROJECT NAME: WATERBURY	
PROJECT NUMBER: IM CULV(109)	
FILE NAME: s22a107BDR.New 3-Sided Frame.dwg	DATE: 28-JUN-2023
PROJECT LEADER: L.J.STONE	DRAWN BY: D.D.BEARD
DESIGNED BY: -----	CHECKED BY: -----
NEW LONGSPAN CULVERT LAYOUT	SHEET 15 OF 48

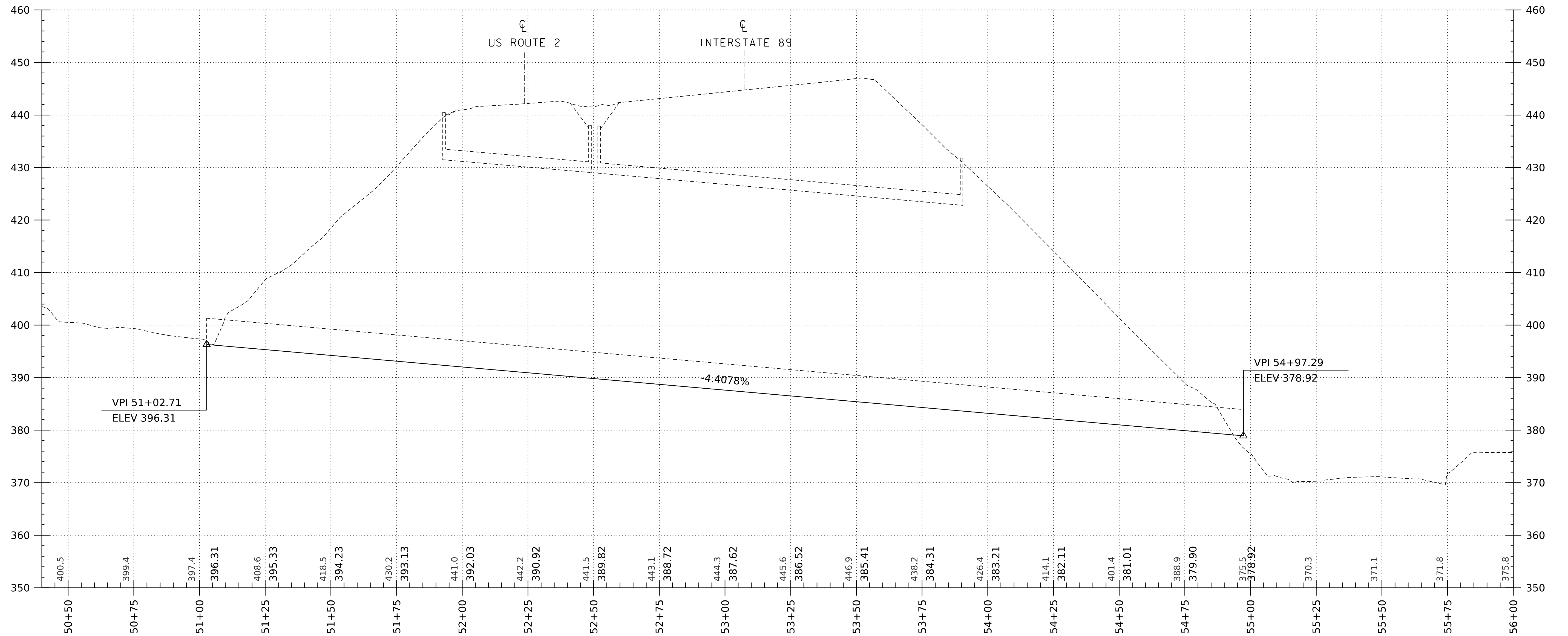

**NEW PRECAST ARCH PROFILE**

SCALE: HORIZONTAL 1"=20'-0"  
 VERTICAL 1"=10'-0"

NOTE:  
 GRADES SHOWN TO THE NEAREST TENTH ARE EXISTING GROUND ALONG  $\phi$   
 GRADES SHOWN TO THE NEAREST HUNDREDTH ARE FINISH GRADE ALONG  $\phi$

PROJECT NAME: WATERBURY	PLOT DATE: 28-JUN-2023
PROJECT NUMBER: IM CULV(109)	DRAWN BY: D.D.BEARD
FILE NAME: s22a107profile.dgn	CHECKED BY: -----
PROJECT LEADER: L.J.STONE	SHEET 16 OF 48
DESIGNED BY: -----	
NEW PRECAST ARCH PROFILE SHEET	



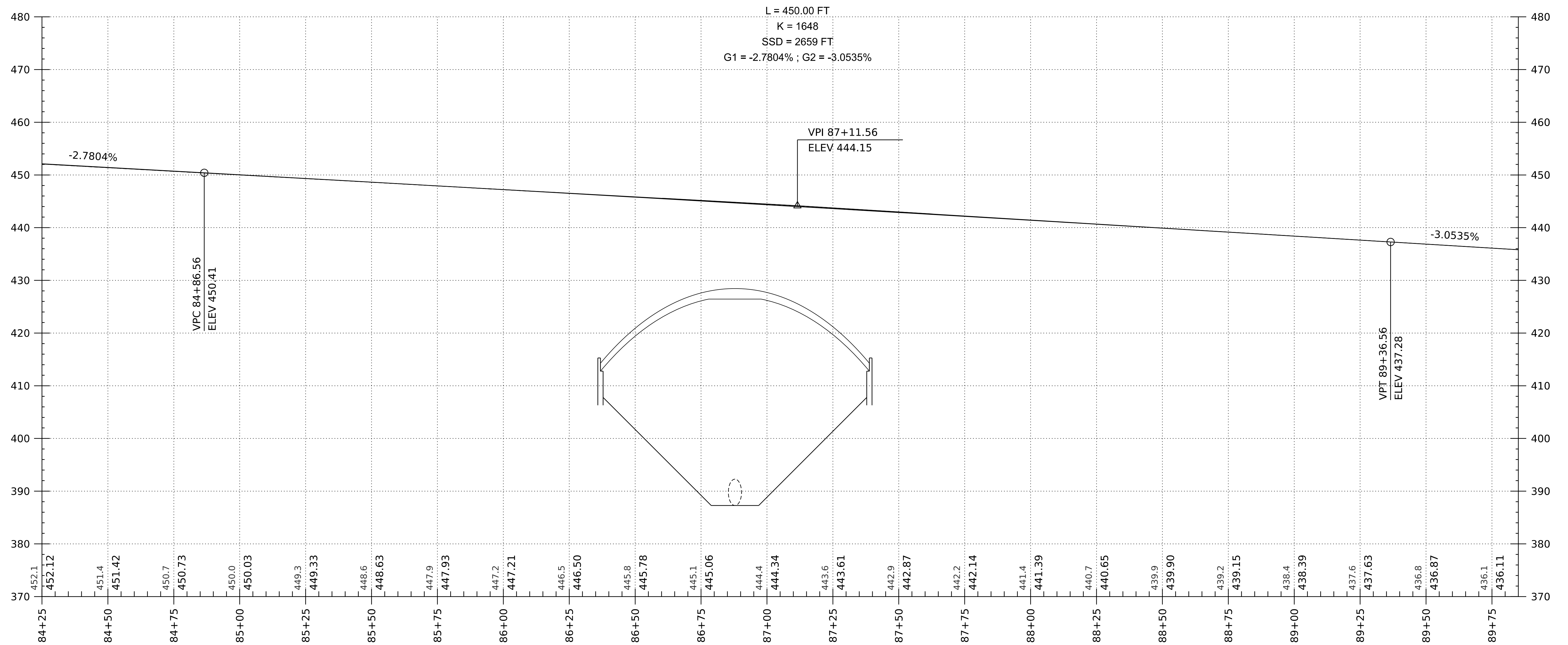

INTERSTATE 89 NEW PRECAST ARCH BRIDGE PROFILE

SCALE: HORIZONTAL 1"=20'-0"  
 VERTICAL 1"=10'-0"

NOTE:  
 GRADES SHOWN TO THE NEAREST  
 TENTH ARE EXISTING GROUND ALONG  $\phi$   
 GRADES SHOWN TO THE NEAREST  
 HUNDREDTH ARE FINISH GRADE ALONG  $\phi$

PROJECT NAME: WATERBURY	
PROJECT NUMBER: IM CULV(109)	
FILE NAME: s22a107profile.dgn	PLOT DATE: 28-JUN-2023
PROJECT LEADER: L.J.STONE	DRAWN BY: D.D.BEARD
DESIGNED BY: -----	CHECKED BY: -----
INTERSTATE 89 PRECAST ARCH PROFILE SHEETSHEET 17 OF 48	

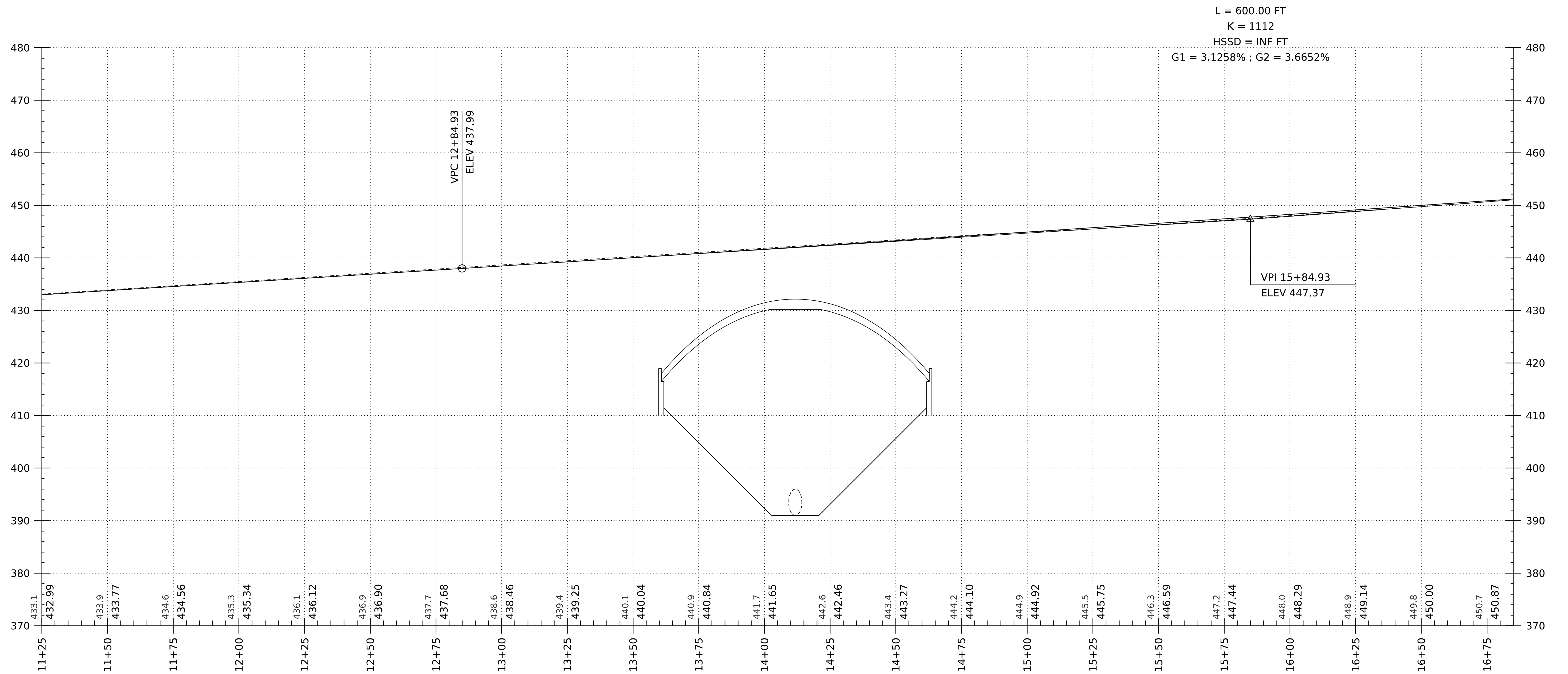

**US ROUTE 2 NEW PRECAST ARCH PROFILE**

SCALE: HORIZONTAL 1"=20'-0"  
 VERTICAL 1"=10'-0"

NOTE:  
 GRADES SHOWN TO THE NEAREST  
 TENTH ARE EXISTING GROUND ALONG  $\phi$   
 GRADES SHOWN TO THE NEAREST  
 HUNDREDTH ARE FINISH GRADE ALONG  $\phi$

PROJECT NAME: WATERBURY	
PROJECT NUMBER: IM CULV(109)	
FILE NAME: s22a107profile.dgn	PLOT DATE: 28-JUN-2023
PROJECT LEADER: L.J.STONE	DRAWN BY: D.D.BEARD
DESIGNED BY: -----	CHECKED BY: -----
US ROUTE 2 PRECAST ARCH PROFILE SHEET	SHEET 18 OF 48

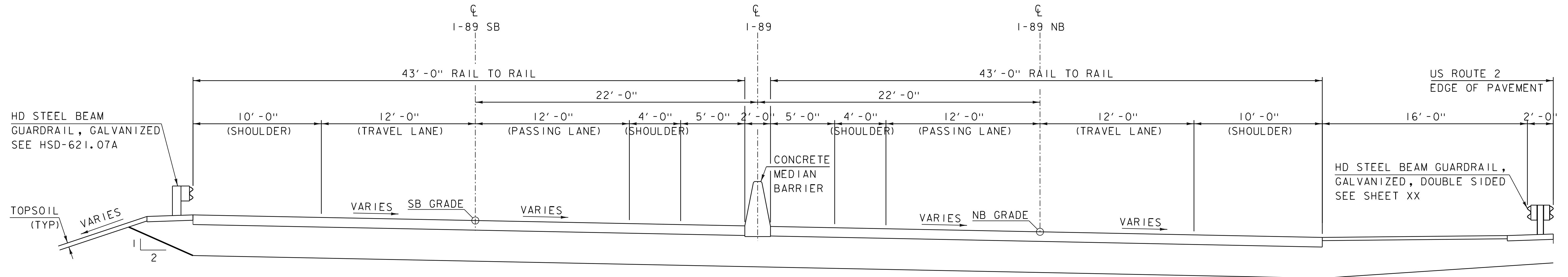

I-89 NEW BRIDGE TYPICAL SECTION

SCALE: 1/4" = 1'-0"

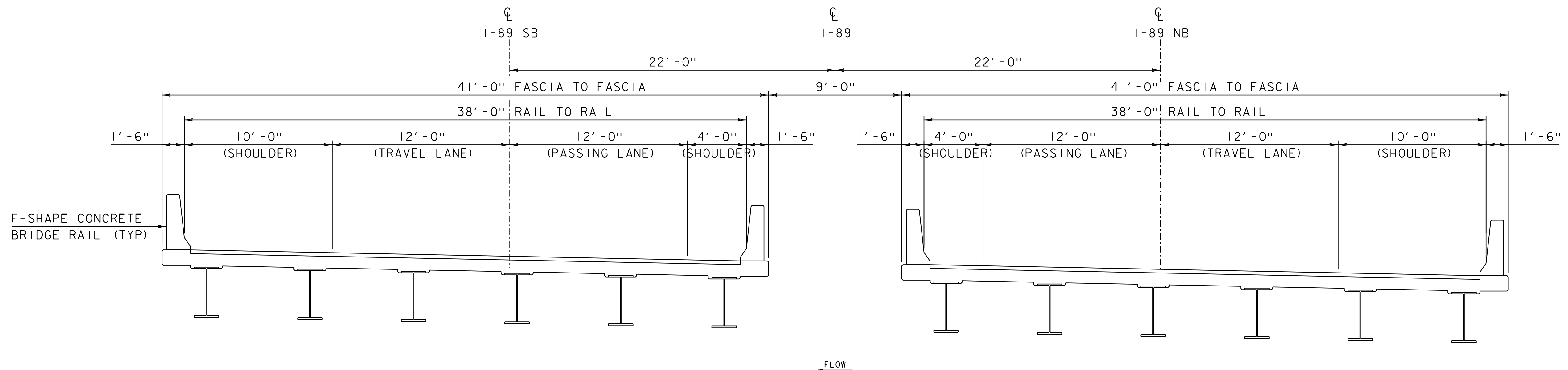

I-89 NEW BRIDGE TYPICAL SECTION

SCALE: 1/4" = 1'-0"

PROJECT NAME:	WATERBURY	PLOT DATE:	28-JUN-2023
PROJECT NUMBER:	IM CULV(109)	DRAWN BY:	D.D.BEARD
FILE NAME:	22cl07/s22cl07typ.dgn	DESIGNED BY:	-----
PROJECT LEADER:	L.J.STONE	CHECKED BY:	-----
INTERSTATE 89 TYPICAL SECTIONS		SHEET	19 OF 48

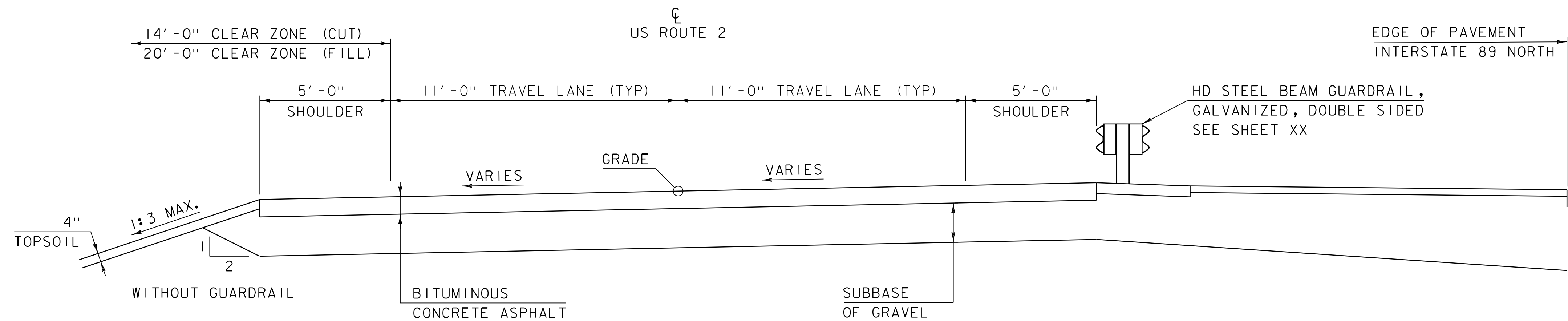
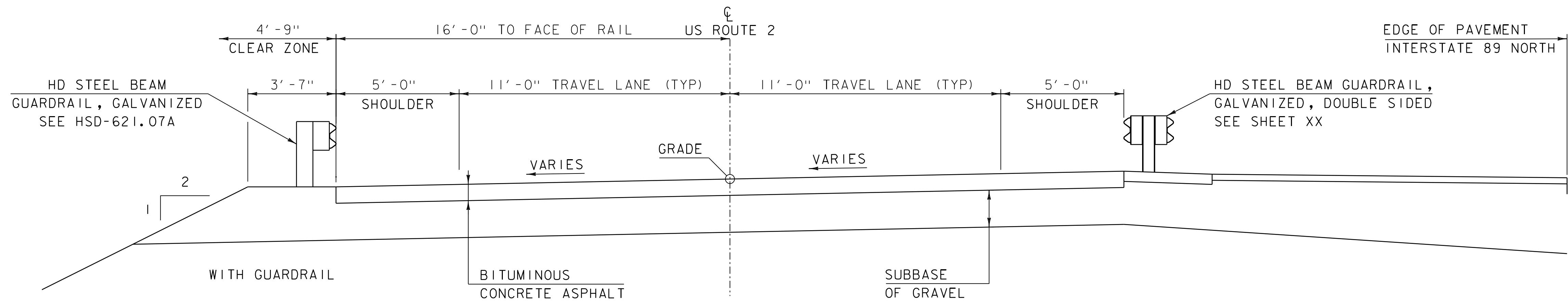

**PROPOSED US ROUTE 2 TYPICAL SECTION**

SCALE 3/8" = 1'-0"

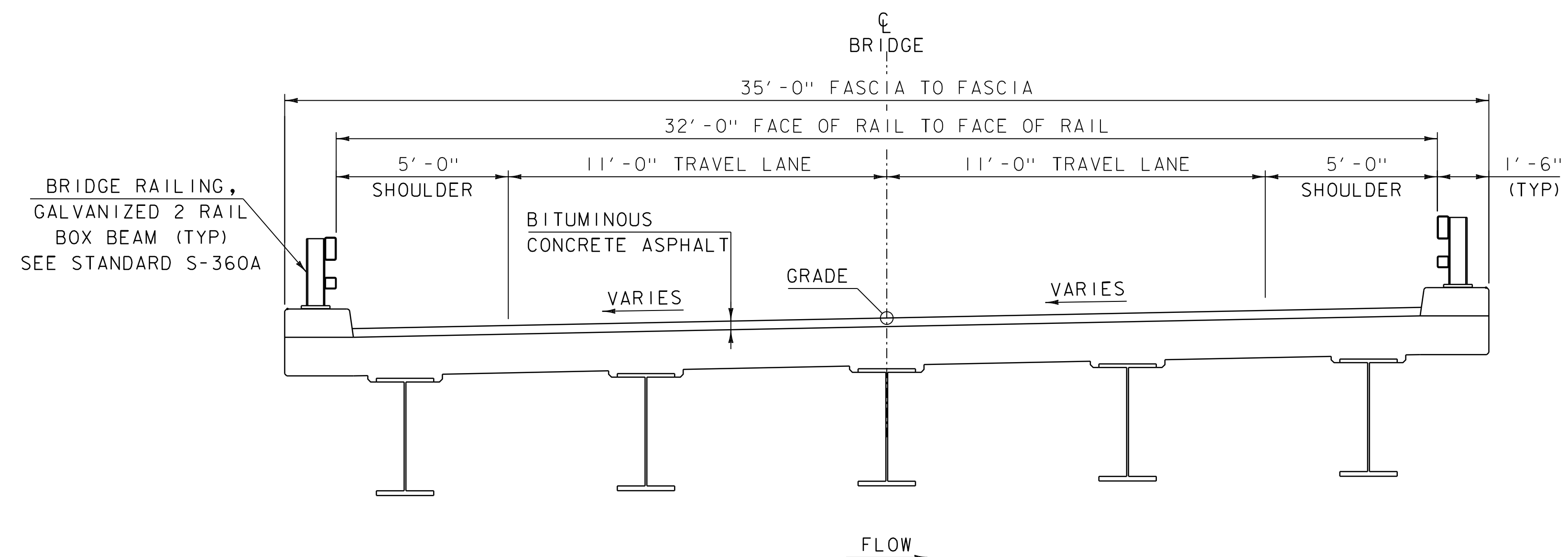

**PROPOSED BRIDGE TYPICAL SECTION**

SCALE 3/8" = 1'-0"

**MATERIAL TOLERANCES**  
(IF USED ON PROJECT)

SURFACE	
- PAVEMENT (TOTAL THICKNESS)	+/- 1/4"
- AGGREGATE SURFACE COURSE	+/- 1/2"
SUBBASE	
	+/- 1"
SAND BORROW	
	+/- 1"

PROJECT NAME: WATERBURY  
PROJECT NUMBER: IM CULV(109)

FILE NAME: 22al07/s22al07typ.dgn  
PROJECT LEADER: L.J.STONE  
DESIGNED BY: -----  
US ROUTE 2 TYPICAL SECTIONS

PLOT DATE: 28-JUN-2023  
DRAWN BY: D.D.BEARD  
CHECKED BY: -----  
SHEET 20 OF 48

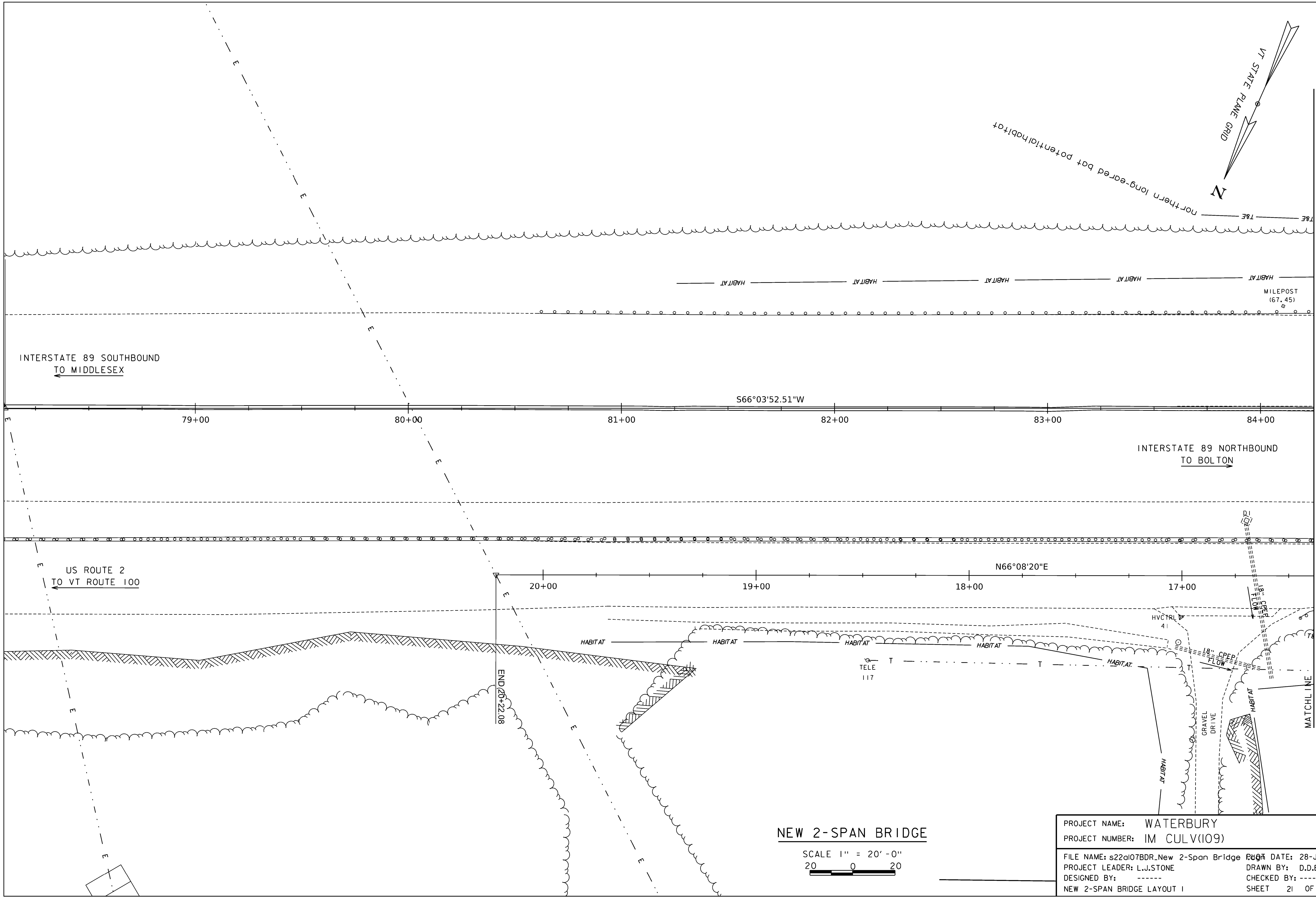

INTERSTATE 89 SOUTHBOUND  
TO MIDDLESEX

US ROUTE 2  
TO VT ROUTE 100

S66°03'52.51"W

N66°08'20"E

END 20+22.08

MATCHLINE  
STA 84+25

**NEW 2-SPAN BRIDGE**

SCALE 1" = 20'-0"  
20 0 20

PROJECT NAME:	WATERBURY		
PROJECT NUMBER:	IM CULV(109)		
FILE NAME:	s22a107BDR.New 2-Span Bridge	DATE:	28-JUN-2023
PROJECT LEADER:	L.J.STONE	DRAWN BY:	D.D.BEARD
DESIGNED BY:	-----	CHECKED BY:	-----
NEW 2-SPAN BRIDGE LAYOUT 1		SHEET	21 OF 48

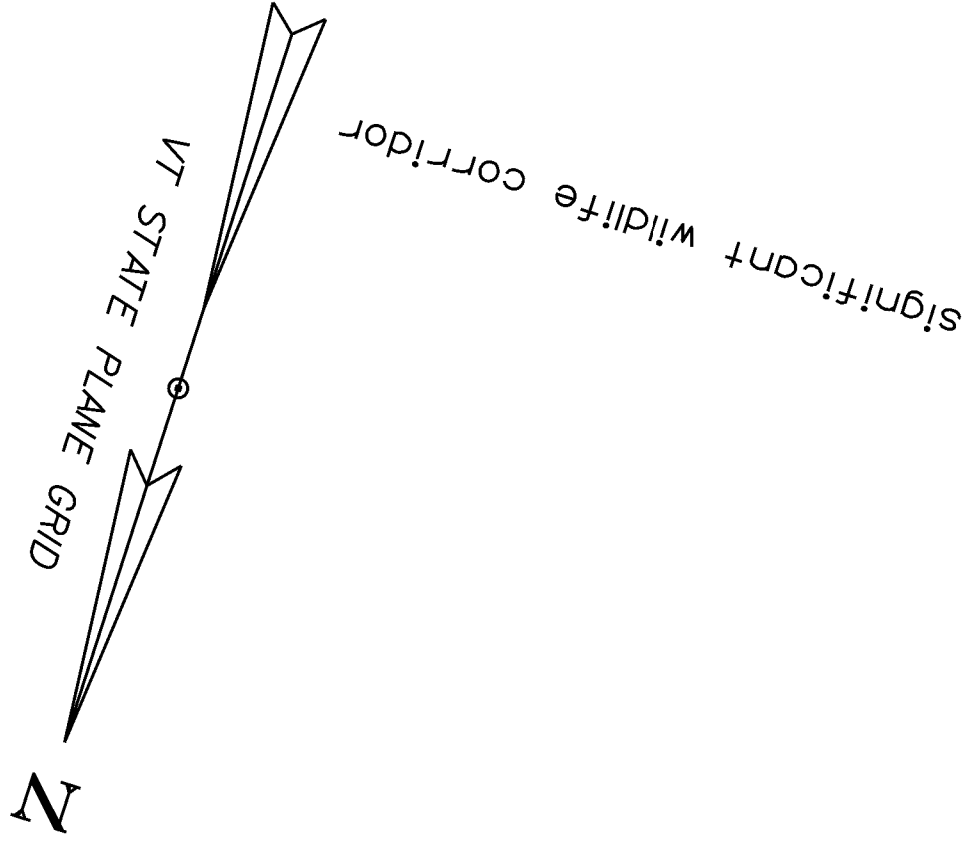

BENCHMARK  
CHISELED SQUARE ON TOP  
OF CONCRETE SIGN BASE  
ELEV. = 438.62

1-89 86+87.85=  
CHAN 53+07.58  
 $\Delta = 73^{\circ}01'35''$ RT

INTERSTATE 89 SOUTHBOUND  
TO MIDDLESEX

INTERSTATE 89 NORTHBOUND  
TO BOLTON

US ROUTE 2  
TO VT ROUTE 100

US ROUTE 2  
TO BOLTON

US-2 14+11.75  
CHAN 52+23.60  
 $\Delta = 113^{\circ}05'10''$ LT

MATCHLINE  
STA 84+25

MATCHLINE  
STA 89+75

NEW 2-SPAN BRIDGES

SCALE 1" = 20'-0"  
20 0 20

PROJECT NAME:	WATERBURY		
PROJECT NUMBER:	IM 089-2(57)		
FILE NAME:	22a107BDR_New 2-Span Bridge 2023	DATE:	28-JUN-2023
PROJECT LEADER:	L.J.STONE	DRAWN BY:	D.D.BEARD
DESIGNED BY:	-----	CHECKED BY:	-----
NEW 2-SPAN BRIDGES LAYOUT 2		SHEET	22 OF 48

BROKEN CONCRETE  
BOUNDARY MARKER  
REBAR UP 4"

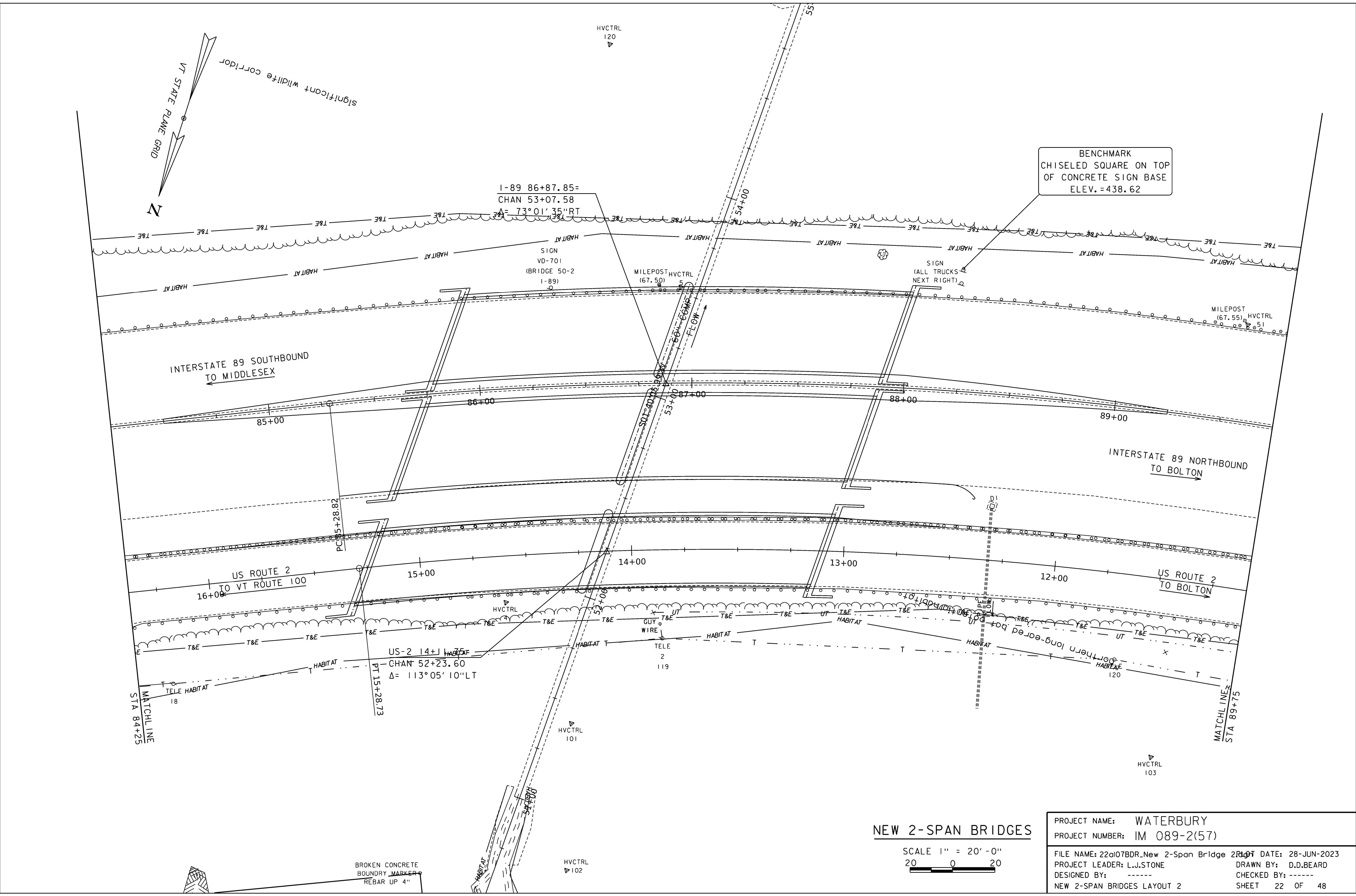

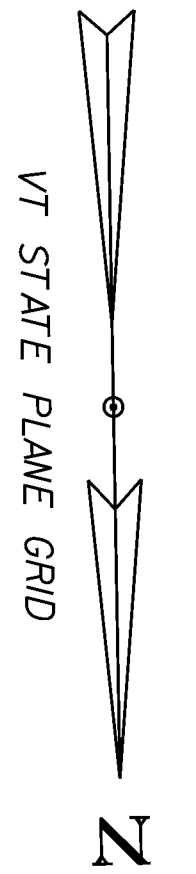

e = 201.98  
28.51

INTERSTATE 89 SOUTHBOUND  
TO MIDDLESEX

INTERSTATE 89 NORTHBOUND  
TO BOLTON

US ROUTE 2  
TO VT ROUTE 100

US ROUTE 2  
TO BOLTON

BENCHMARK  
RAILROAD SPIKE  
IN POLE  
ELEV. = 420.60

significant wildlife corridor

### NEW 2-SPAN BRIDGE

SCALE 1" = 20'-0"  
20 0 20

PROJECT NAME:	WATERBURY
PROJECT NUMBER:	IM CULV(109)
FILE NAME:	s22a107BDR.New 2-Span Bridge 11.dgn
DATE:	28-JUN-2023
PROJECT LEADER:	L.J.STONE
DRAWN BY:	D.D.BEARD
DESIGNED BY:	-----
CHECKED BY:	-----
NEW 2-SPAN BRIDGE LAYOUT 3	SHEET 23 OF 48

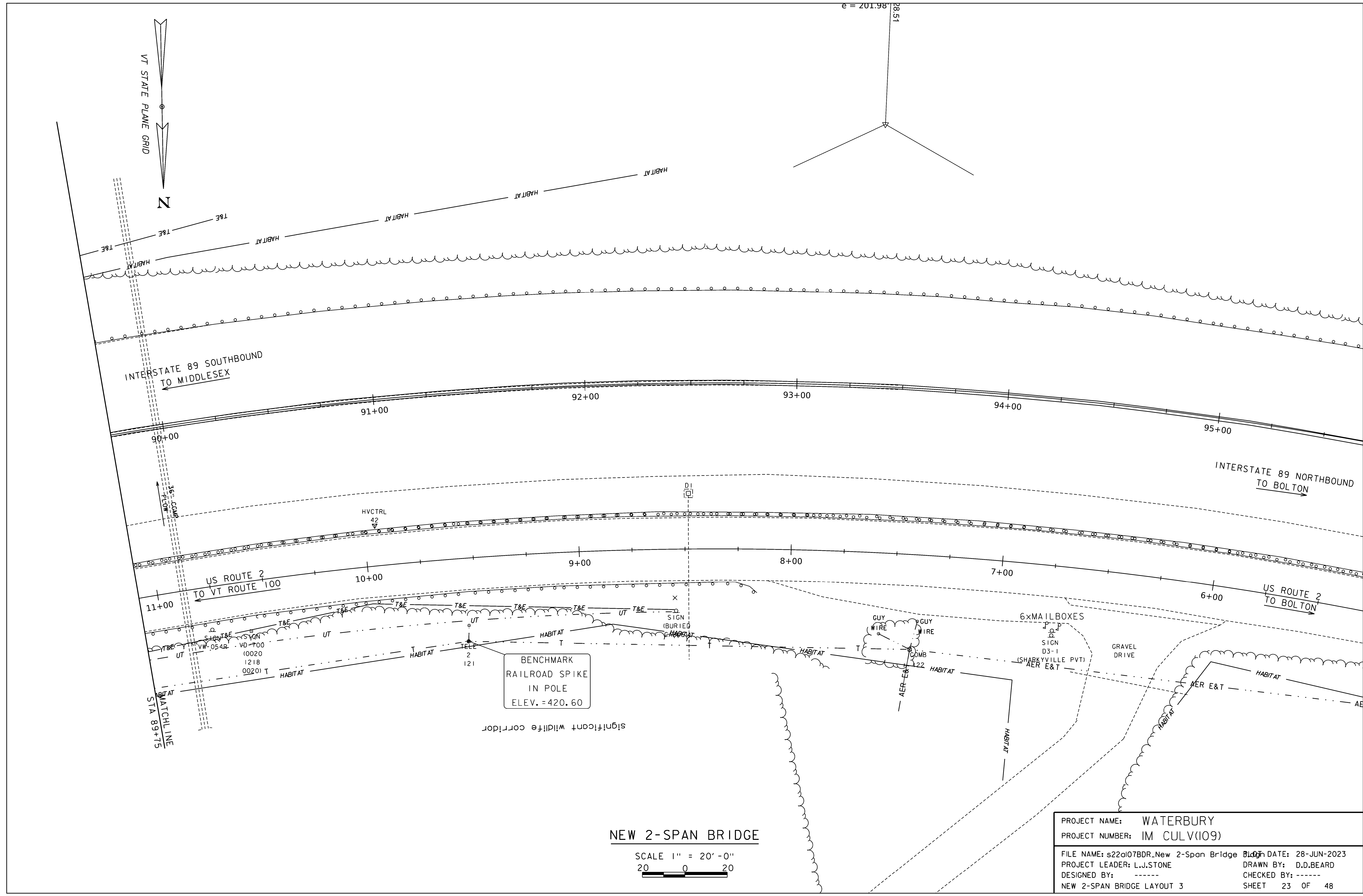

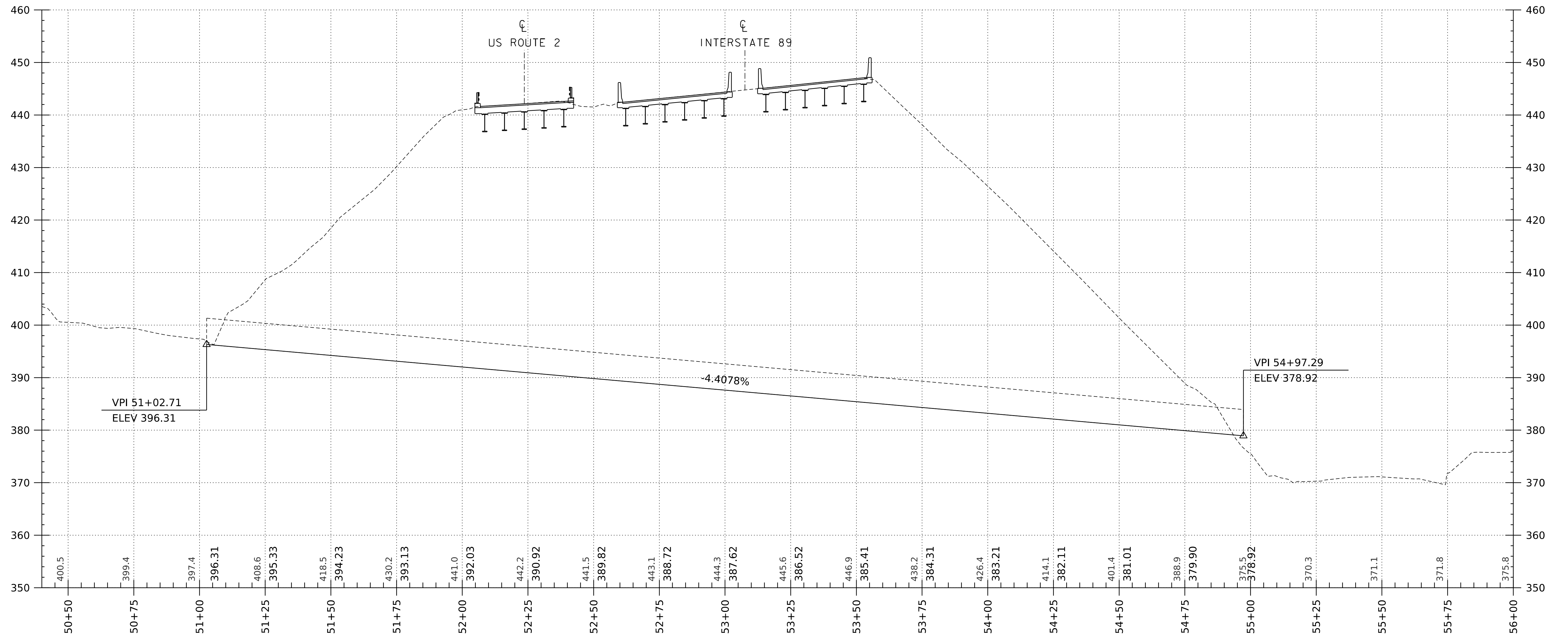

**NEW BRIDGES PROFILE**

SCALE: HORIZONTAL 1"=20'-0"  
 VERTICAL 1"=10'-0"

NOTE:  
 GRADES SHOWN TO THE NEAREST TENTH ARE EXISTING GROUND ALONG  $\phi$   
 GRADES SHOWN TO THE NEAREST HUNDREDTH ARE FINISH GRADE ALONG  $\phi$

PROJECT NAME: WATERBURY	
PROJECT NUMBER: IM CULV(109)	
FILE NAME: s22a107profile.dgn	PLOT DATE: 28-JUN-2023
PROJECT LEADER: L.J.STONE	DRAWN BY: D.D.BEARD
DESIGNED BY: -----	CHECKED BY: -----
NEW BRIDGES PROFILE SHEET	SHEET 24 OF 48



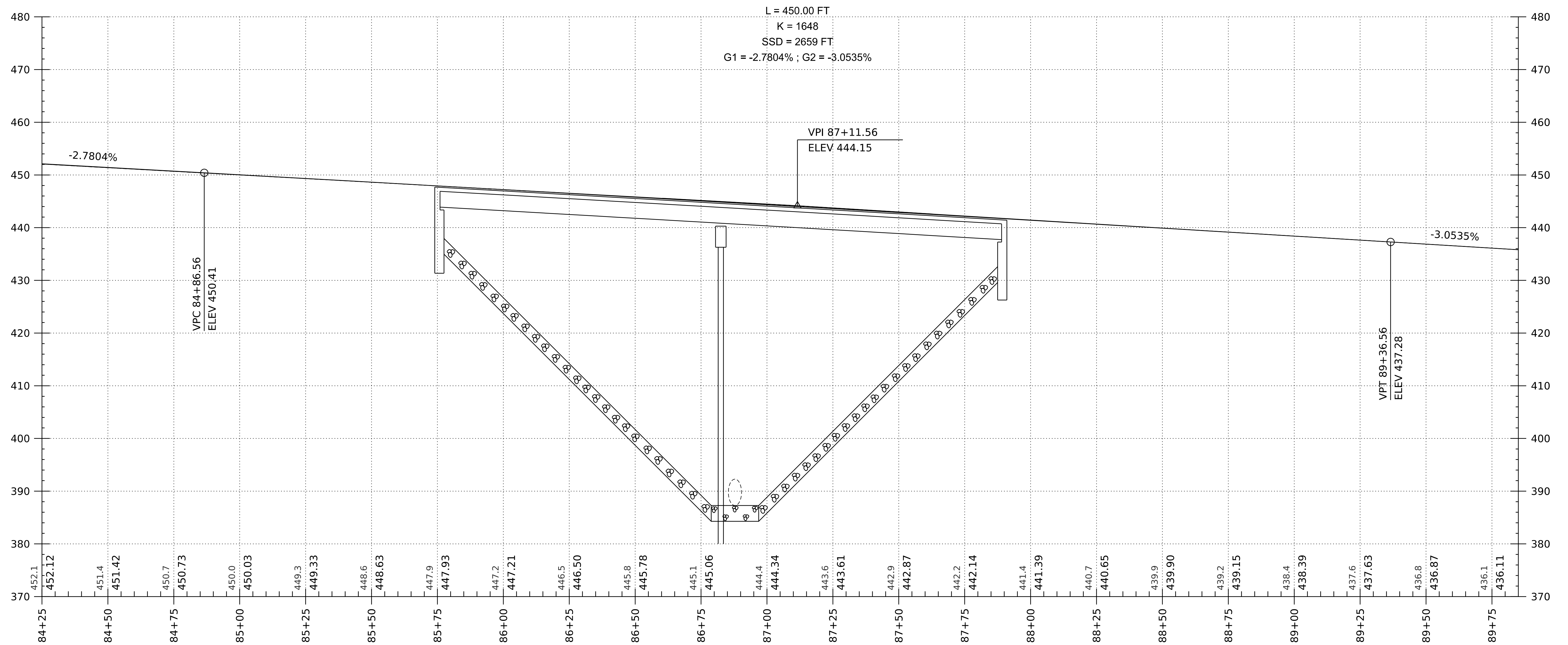

INTERSTATE 89 NEW 2-SPAN BRIDGE PROFILE

SCALE: HORIZONTAL 1"=20'-0"  
 VERTICAL 1"=10'-0"

NOTE:  
 GRADES SHOWN TO THE NEAREST  
 TENTH ARE EXISTING GROUND ALONG  $\phi$   
 GRADES SHOWN TO THE NEAREST  
 HUNDREDTH ARE FINISH GRADE ALONG  $\phi$

PROJECT NAME: WATERBURY	
PROJECT NUMBER: IM CULV(109)	
FILE NAME: s22a107profile.dgn	PLOT DATE: 28-JUN-2023
PROJECT LEADER: L.J.STONE	DRAWN BY: D.D.BEARD
DESIGNED BY: -----	CHECKED BY: -----
INTERSTATE 89 NEW 2-SPAN BRIDGE PROFILE SHEET 25 OF 48	

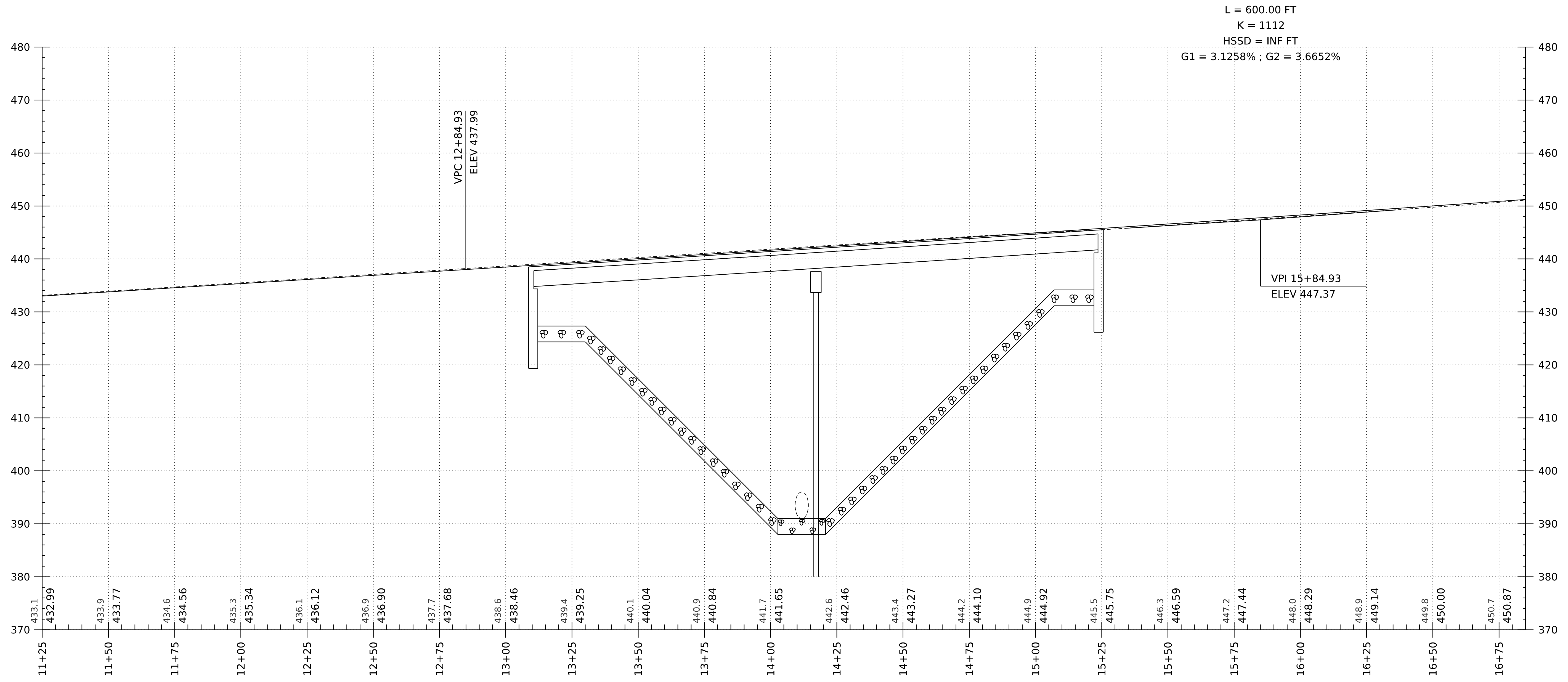

US ROUTE 2 NEW 2-SPAN BRIDGE PROFILE

SCALE: HORIZONTAL 1"=20'-0"  
 VERTICAL 1"=10'-0"

NOTE:  
 GRADES SHOWN TO THE NEAREST TENTH ARE EXISTING GROUND ALONG  $\phi$   
 GRADES SHOWN TO THE NEAREST HUNDREDTH ARE FINISH GRADE ALONG  $\phi$

PROJECT NAME: WATERBURY	
PROJECT NUMBER: IM CULV(109)	
FILE NAME: s22a107profile.dgn	PLOT DATE: 28-JUN-2023
PROJECT LEADER: L.J.STONE	DRAWN BY: D.D.BEARD
DESIGNED BY: -----	CHECKED BY: -----
US ROUTE 2 NEW 2-SPAN BRIDGE PROFILE SHEET 26 OF 48	

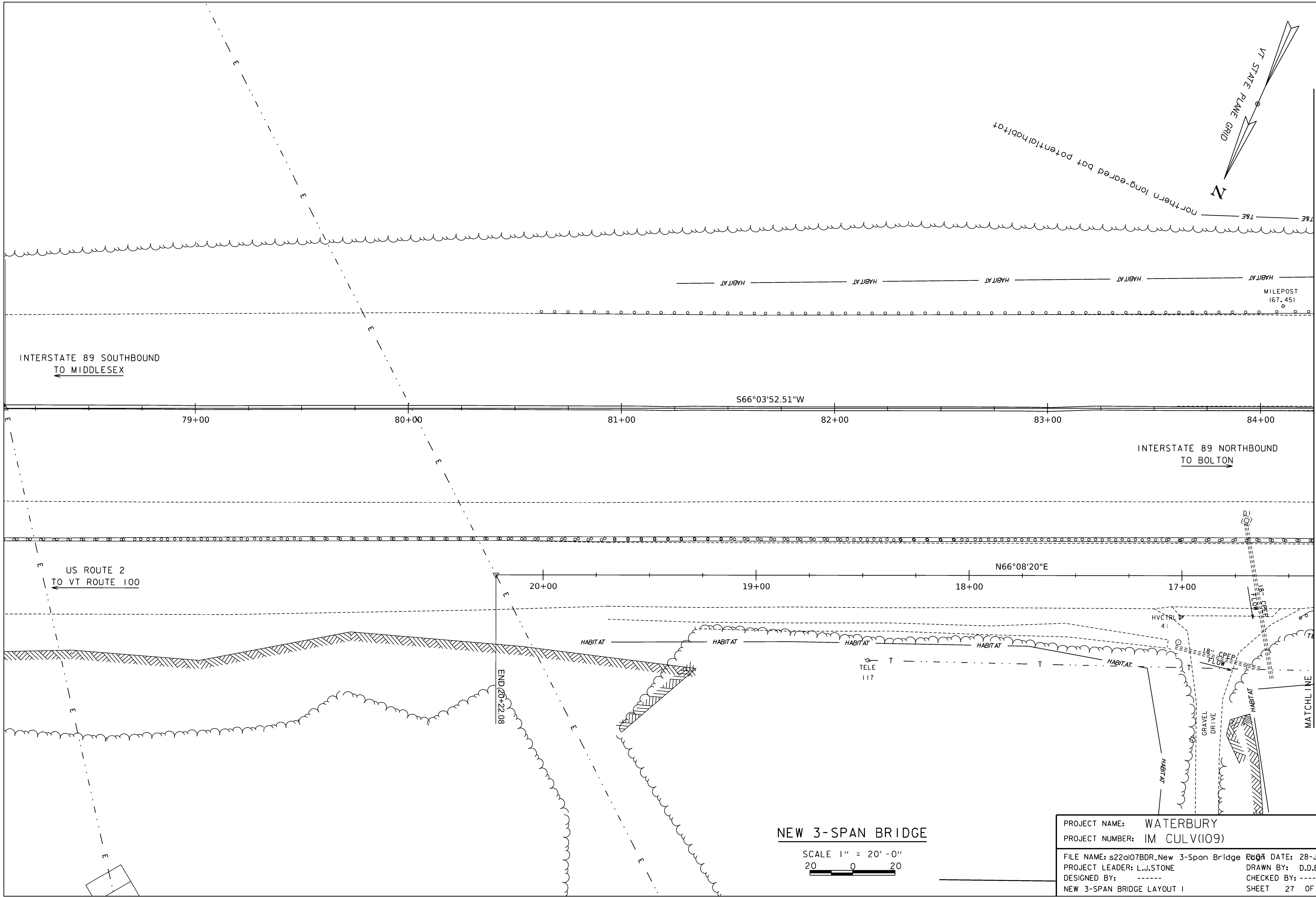

INTERSTATE 89 SOUTHBOUND  
TO MIDDLESEX

US ROUTE 2  
TO VT ROUTE 100

S66°03'52.51"W

N66°08'20"E

END 20+22.08

MATCHLINE  
STA 84+25

**NEW 3-SPAN BRIDGE**

SCALE 1" = 20'-0"  
20 0 20

PROJECT NAME:	WATERBURY		
PROJECT NUMBER:	IM CULV(109)		
FILE NAME:	s22a107BDR.New 3-Span Bridge	DATE:	28-JUN-2023
PROJECT LEADER:	L.J.STONE	DRAWN BY:	D.D.BEARD
DESIGNED BY:	-----	CHECKED BY:	-----
NEW 3-SPAN BRIDGE LAYOUT 1		SHEET	27 OF 48

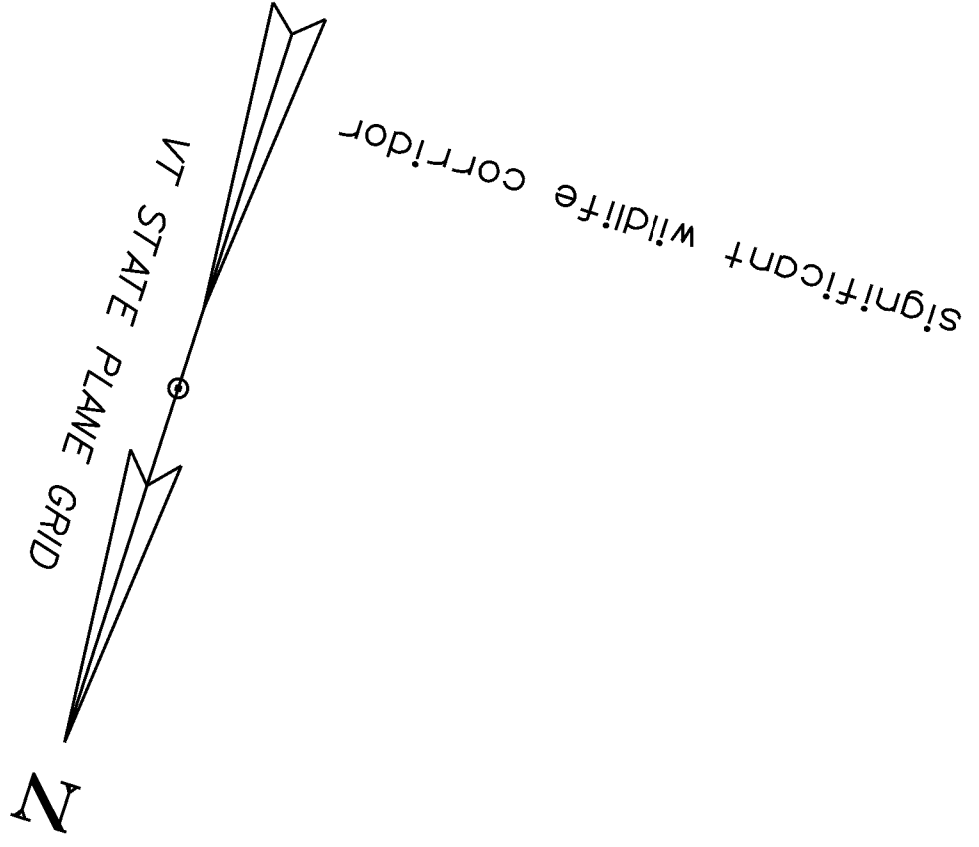

BENCHMARK  
CHISELED SQUARE ON TOP  
OF CONCRETE SIGN BASE  
ELEV. = 438.62

1-89 86+87.85=  
CHAN 53+07.58  
 $\Delta = 73^{\circ}01'35''RT$   
SIGN  
VD-701  
(BRIDGE 50-2  
1-89)

MILEPOST  
(67.50)

SIGN  
(ALL TRUCKS  
NEXT RIGHT)

MILEPOST  
(67.55)

INTERSTATE 89 SOUTHBOUND  
TO MIDDLESEX

INTERSTATE 89 NORTHBOUND  
TO BOLTON

US ROUTE 2  
TO VT ROUTE 100

US ROUTE 2  
TO BOLTON

US-2 14+11.75  
CHAN 52+23.60  
 $\Delta = 113^{\circ}05'10''LT$

MATCHLINE  
STA 84+25

MATCHLINE  
STA 89+75

NEW 3-SPAN BRIDGES

SCALE 1" = 20'-0"  
20 0 20

PROJECT NAME:	WATERBURY
PROJECT NUMBER:	IM 089-2(57)
FILE NAME:	22a107BDR_New 3-Span Bridge 2023
PROJECT LEADER:	L.J.STONE
DESIGNED BY:	-----
NEW 3-SPAN BRIDGES LAYOUT 2	
DATE:	28-JUN-2023
DRAWN BY:	D.D.BEARD
CHECKED BY:	-----
SHEET	28 OF 48

BROKEN CONCRETE  
BOUNDARY MARKER  
REBAR UP 4"

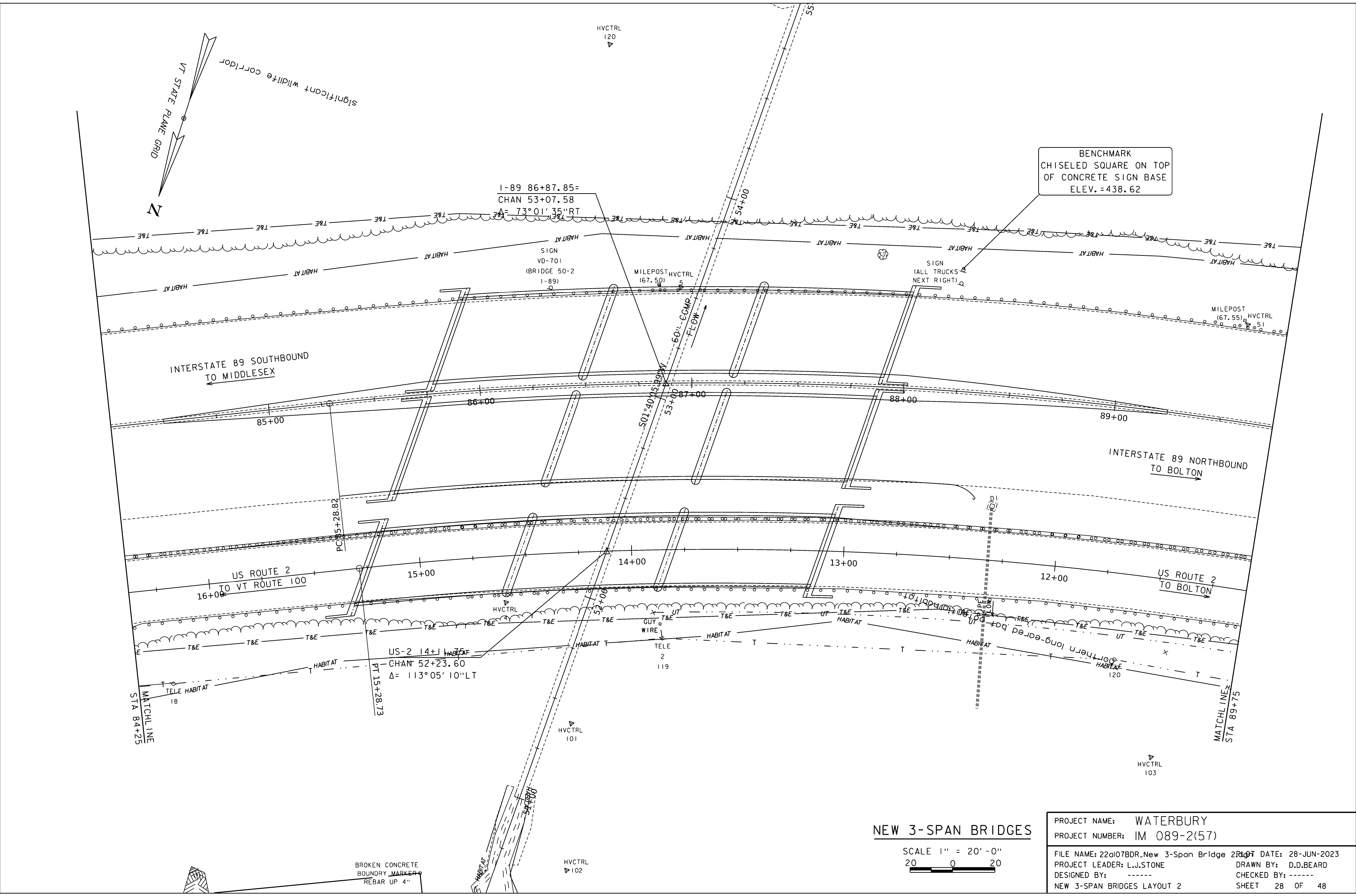

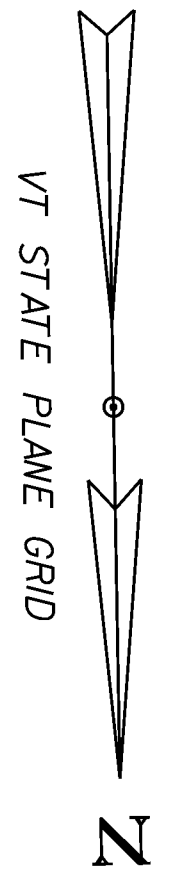

e = 201.98  
28.51

INTERSTATE 89 SOUTHBOUND  
TO MIDDLESEX

INTERSTATE 89 NORTHBOUND  
TO BOLTON

US ROUTE 2  
TO VT ROUTE 100

US ROUTE 2  
TO BOLTON

BENCHMARK  
RAILROAD SPIKE  
IN POLE  
ELEV. = 420.60

significant wildlife corridor

### NEW 3-SPAN BRIDGE

SCALE 1" = 20'-0"  
20 0 20

PROJECT NAME:	WATERBURY		
PROJECT NUMBER:	IM CULV(109)		
FILE NAME:	s22a107BDR.New 3-Span Bridge	DATE:	28-JUN-2023
PROJECT LEADER:	L.J.STONE	DRAWN BY:	D.D.BEARD
DESIGNED BY:	-----	CHECKED BY:	-----
NEW SPAN BRIDGES LAYOUT 3		SHEET 29 OF 48	

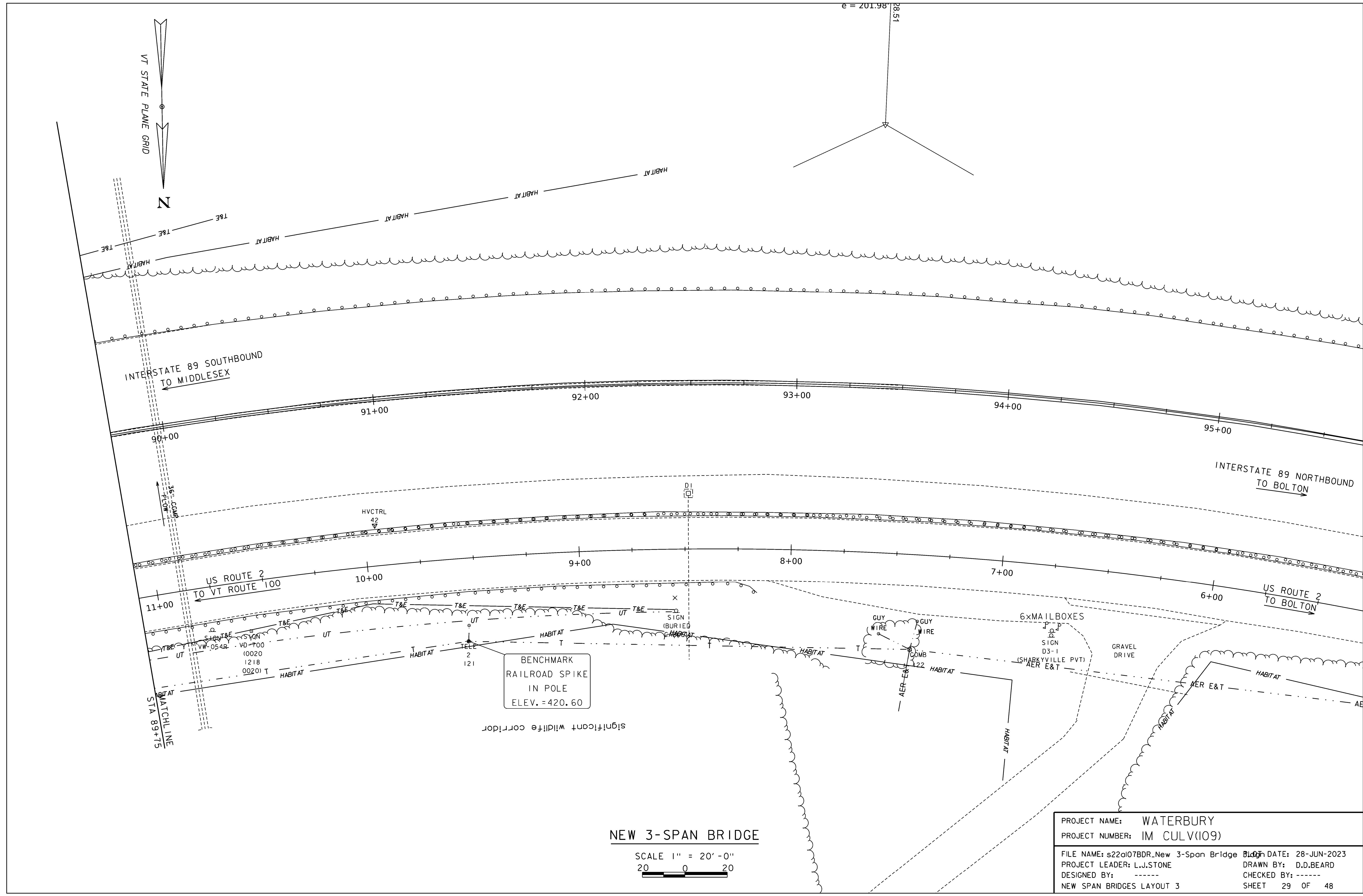

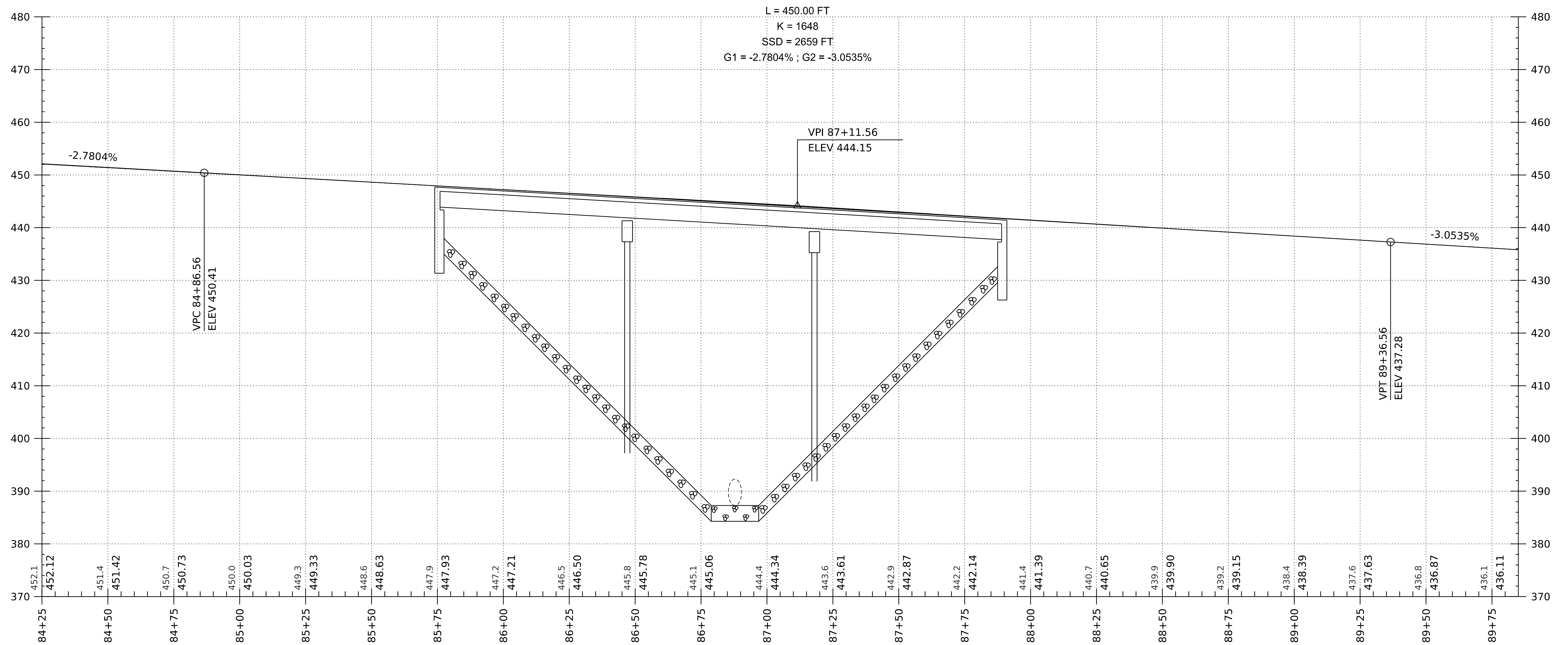

**INTERSTATE 89 NEW 3-SPAN BRIDGE PROFILE**

SCALE: HORIZONTAL 1"=20'-0"  
 VERTICAL 1"=10'-0"

NOTE:  
 GRADES SHOWN TO THE NEAREST  
 TENTH ARE EXISTING GROUND ALONG ☺  
 GRADES SHOWN TO THE NEAREST  
 HUNDREDTH ARE FINISH GRADE ALONG ☺

PROJECT NAME: WATERBURY	
PROJECT NUMBER: IM CULV(109)	
FILE NAME: s22a107profile.dgn	PLOT DATE: 28-JUN-2023
PROJECT LEADER: L.J.STONE	DRAWN BY: D.D.BEARD
DESIGNED BY: -----	CHECKED BY: -----
INTERSTATE 89 NEW 3-SPAN BRIDGE PROFILE SHEET 30 OF 48	

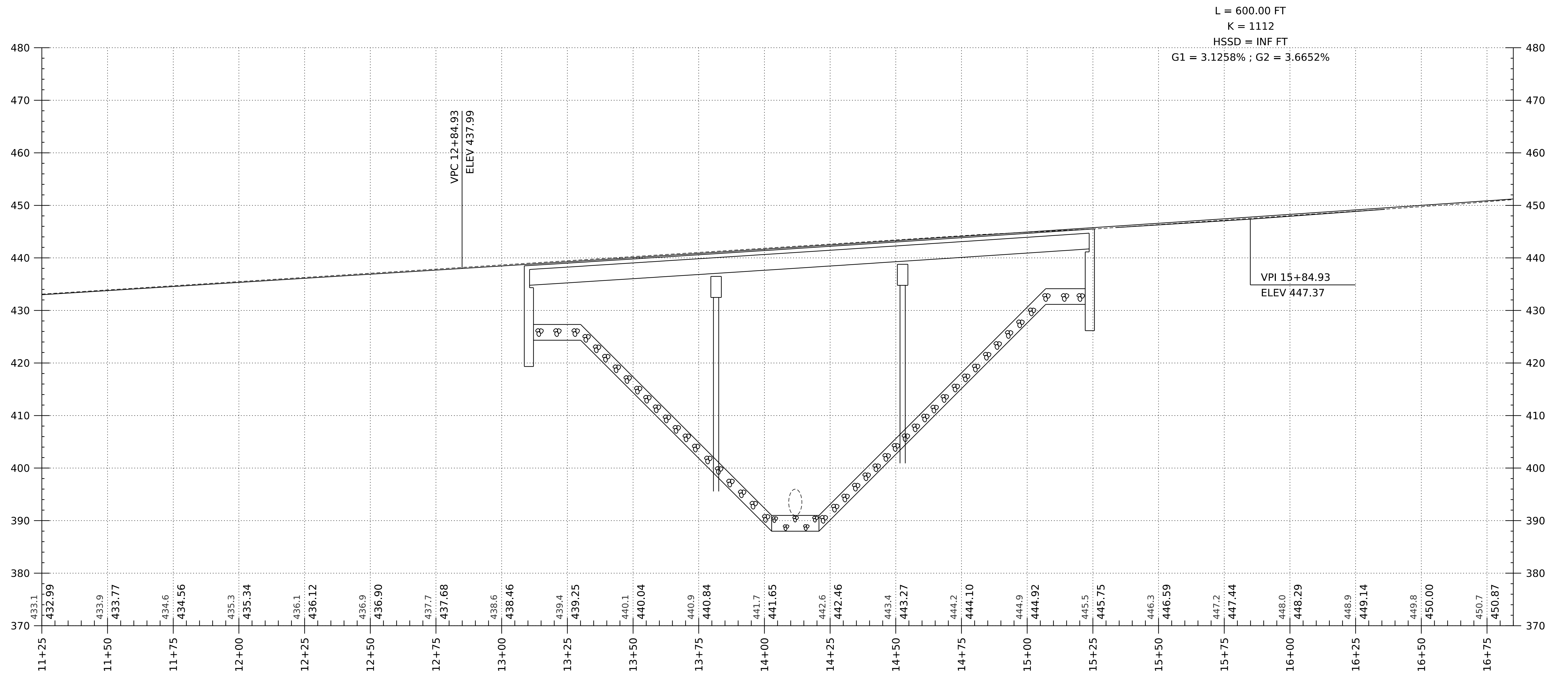

**US ROUTE 2 NEW 3-SPAN BRIDGE PROFILE**

SCALE: HORIZONTAL 1"=20'-0"  
 VERTICAL 1"=10'-0"

NOTE:  
 GRADES SHOWN TO THE NEAREST  
 TENTH ARE EXISTING GROUND ALONG  $\phi$   
 GRADES SHOWN TO THE NEAREST  
 HUNDREDTH ARE FINISH GRADE ALONG  $\phi$

PROJECT NAME: WATERBURY	
PROJECT NUMBER: IM CULV(109)	
FILE NAME: s22a107profile.dgn	PLOT DATE: 28-JUN-2023
PROJECT LEADER: L.J.STONE	DRAWN BY: D.D.BEARD
DESIGNED BY: -----	CHECKED BY: -----
US ROUTE 2 NEW 3-SPAN BRIDGE PROFILE SHEET 31 OF 48	

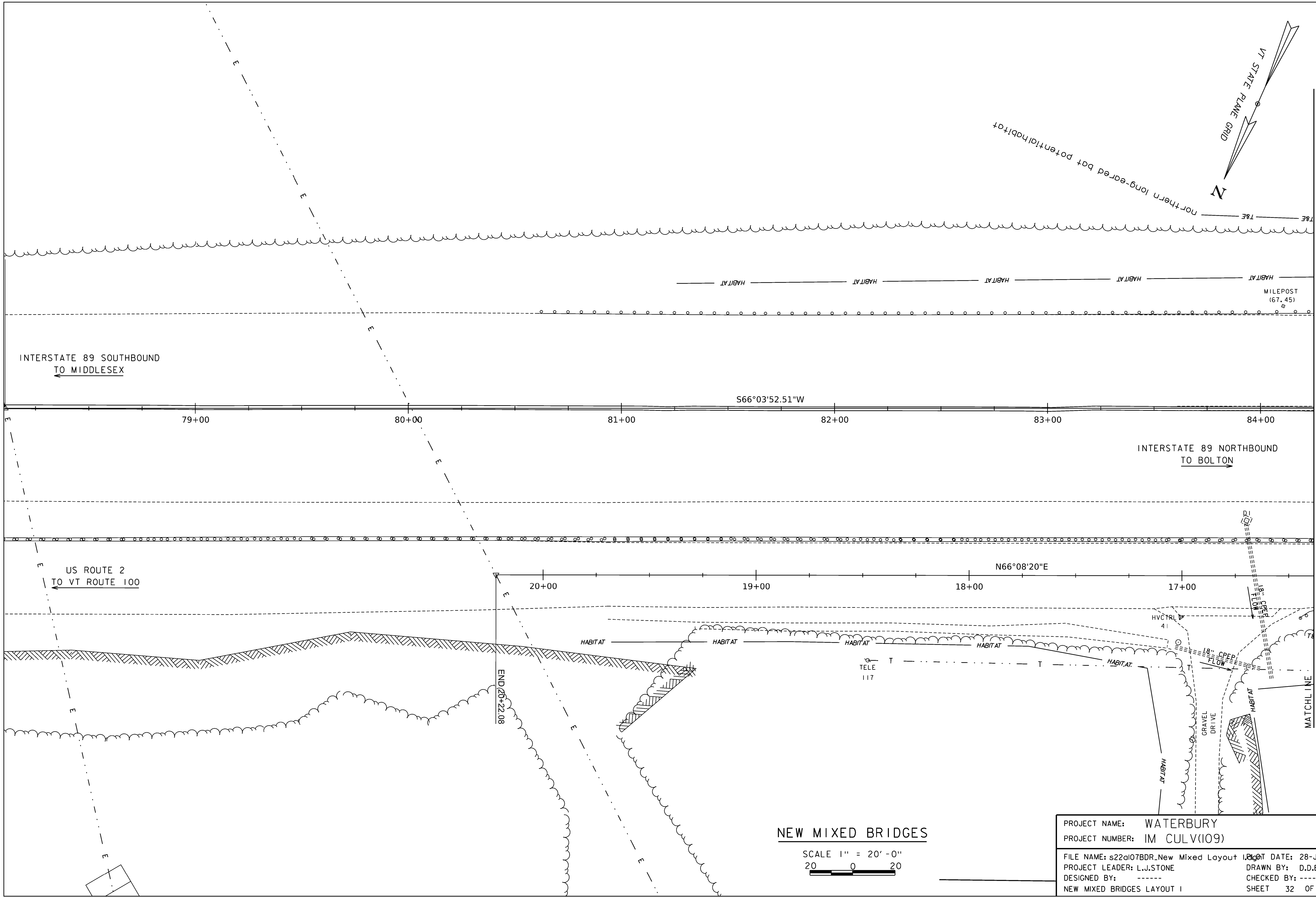

**NEW MIXED BRIDGES**

SCALE 1" = 20' - 0"  
 20 0 20

PROJECT NAME:	WATERBURY
PROJECT NUMBER:	IM CULV(109)
FILE NAME:	s22a107BDR.New Mixed Layout 1.dwg
PROJECT LEADER:	L.J.STONE
DESIGNED BY:	-----
NEW MIXED BRIDGES LAYOUT 1	
DATE:	28-JUN-2023
DRAWN BY:	D.D.BEARD
CHECKED BY:	-----
SHEET	32 OF 48



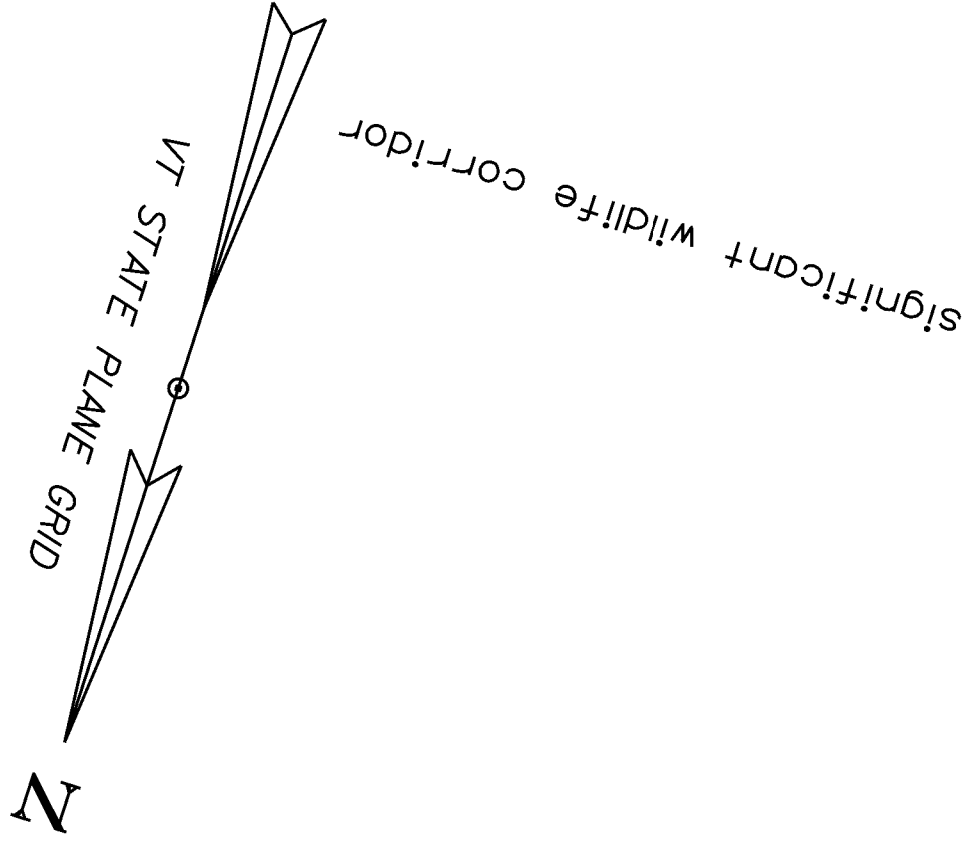

BENCHMARK  
 CHISELED SQUARE ON TOP  
 OF CONCRETE SIGN BASE  
 ELEV. = 438.62

1-89 86+87.85=  
 CHAN 53+07.58  
 $\Delta = 73^{\circ}01'35''RT$   
 SIGN  
 VD-701  
 (BRIDGE 50-2  
 1-89)

SIGN  
 (ALL TRUCKS  
 NEXT RIGHT)

INTERSTATE 89 SOUTHBOUND  
 TO MIDDLESEX

INTERSTATE 89 NORTHBOUND  
 TO BOLTON

US ROUTE 2  
 TO VT ROUTE 100

US ROUTE 2  
 TO BOLTON

US-2 14+11.75  
 CHAN 52+23.60  
 $\Delta = 113^{\circ}05'10''LT$

MATCHLINE  
 STA 84+25

MATCHLINE  
 STA 89+75

**NEW MIXED BRIDGES**

SCALE 1" = 20'-0"  
 20 0 20

PROJECT NAME:	WATERBURY		
PROJECT NUMBER:	IM 089-2(57)		
FILE NAME:	22a107BDR_New Mixed Layout 2.096	DATE:	28-JUN-2023
PROJECT LEADER:	L.J.STONE	DRAWN BY:	D.D.BEARD
DESIGNED BY:	-----	CHECKED BY:	-----
NEW MIXED BRIDGES LAYOUT 2		SHEET 33 OF 48	

BROKEN CONCRETE  
 BOUNDARY MARKER  
 REBAR UP 4"

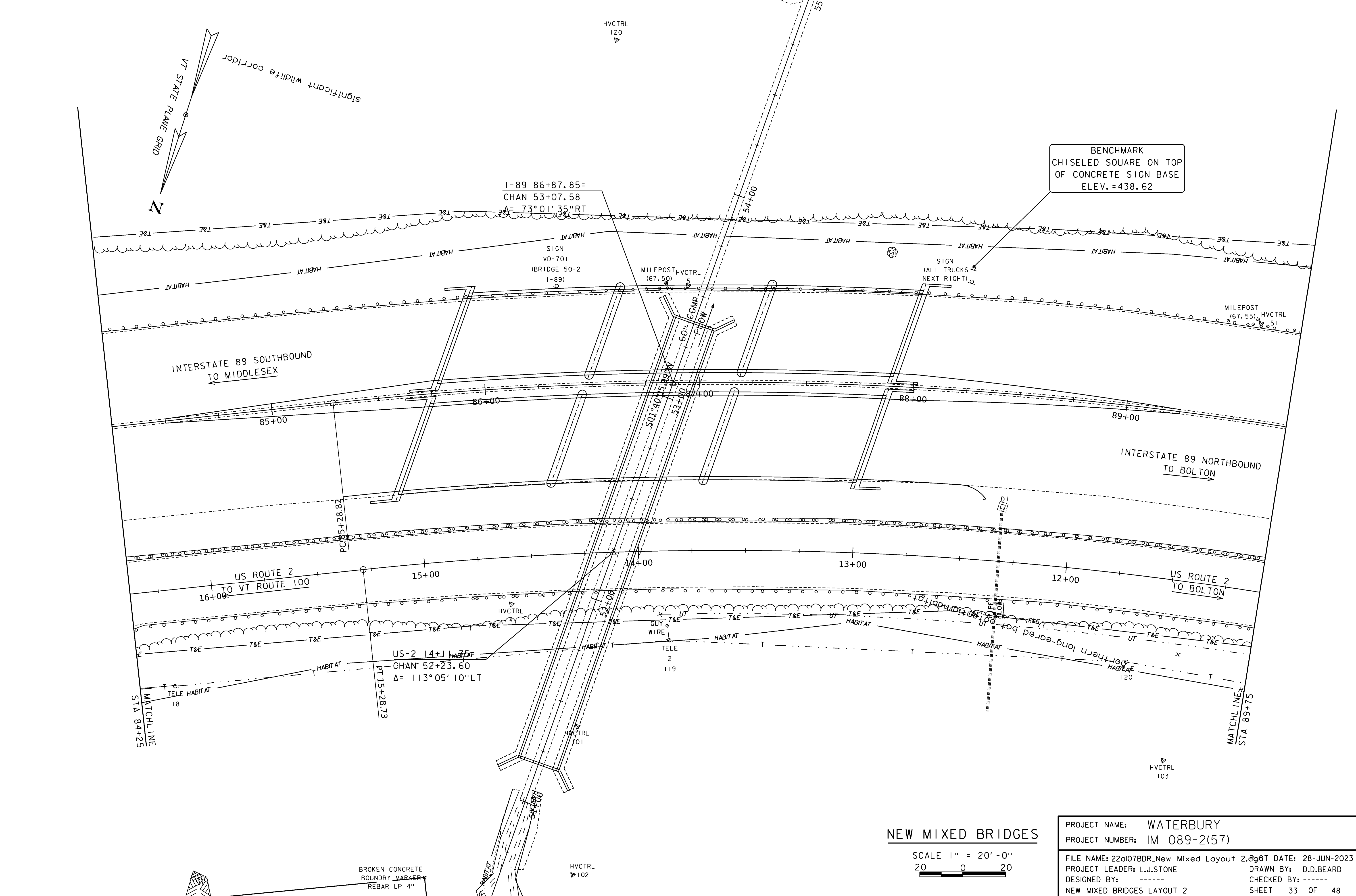

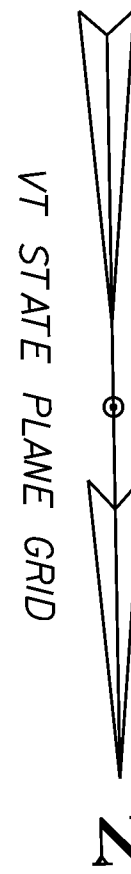

e = 201.98  
28.51

INTERSTATE 89 SOUTHBOUND  
TO MIDDLESEX

INTERSTATE 89 NORTHBOUND  
TO BOLTON

US ROUTE 2  
TO VT ROUTE 100

US ROUTE 2  
TO BOLTON

MATCHLINE  
STA 89+75

BENCHMARK  
RAILROAD SPIKE  
IN POLE  
ELEV. = 420.60

significant wildlife corridor

**NEW MIXED BRIDGE**

SCALE 1" = 20'-0"  
20 0 20

PROJECT NAME: WATERBURY	
PROJECT NUMBER: IM CULV(109)	
FILE NAME: s22a107BDR_New Mixed Layout BPI103e.DWG	DATE: 28-JUN-2023
PROJECT LEADER: L.J.STONE	DRAWN BY: D.D.BEARD
DESIGNED BY: -----	CHECKED BY: -----
NEW MIXED BRIDGES LAYOUT 3	SHEET 34 OF 48

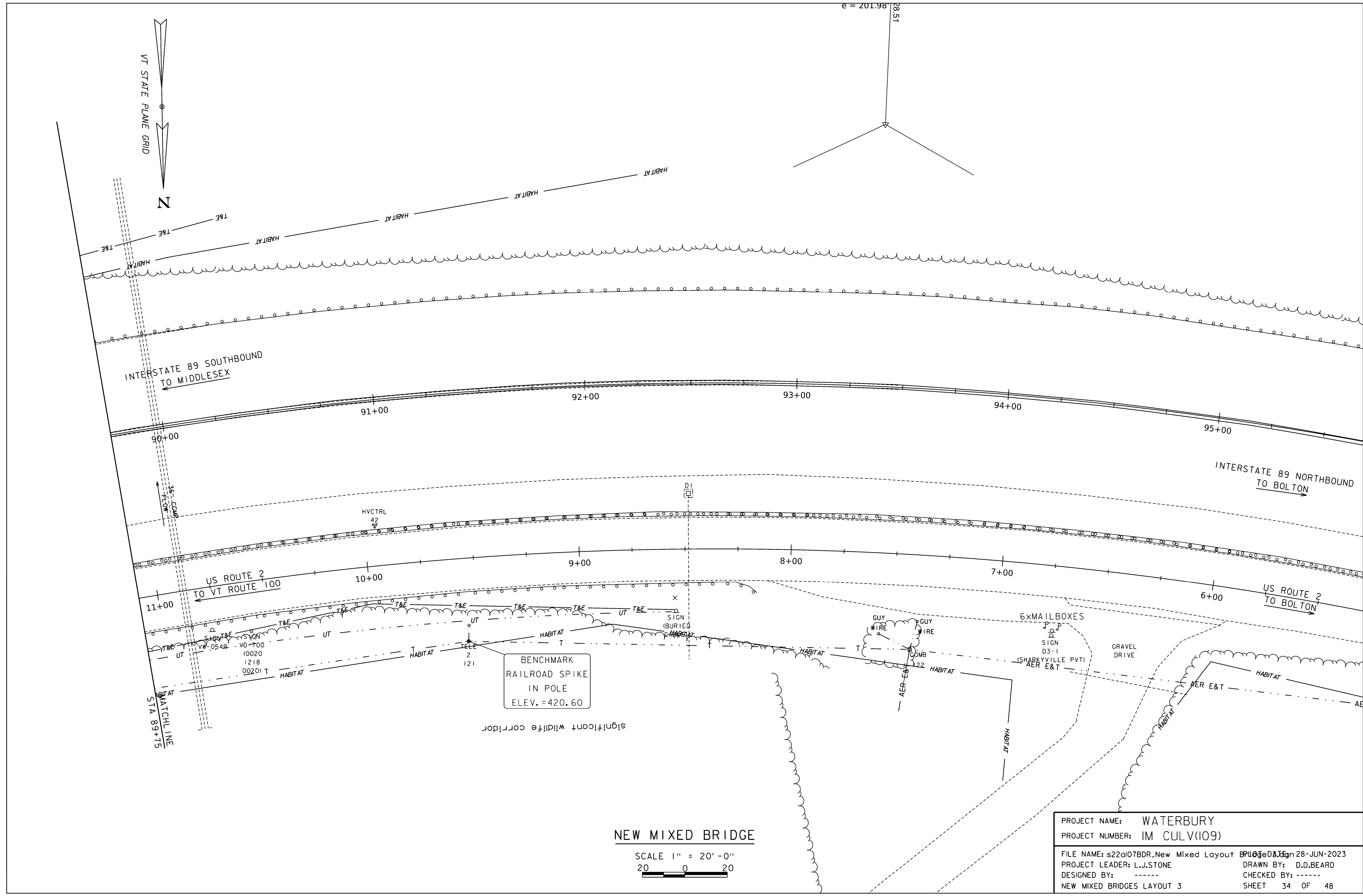

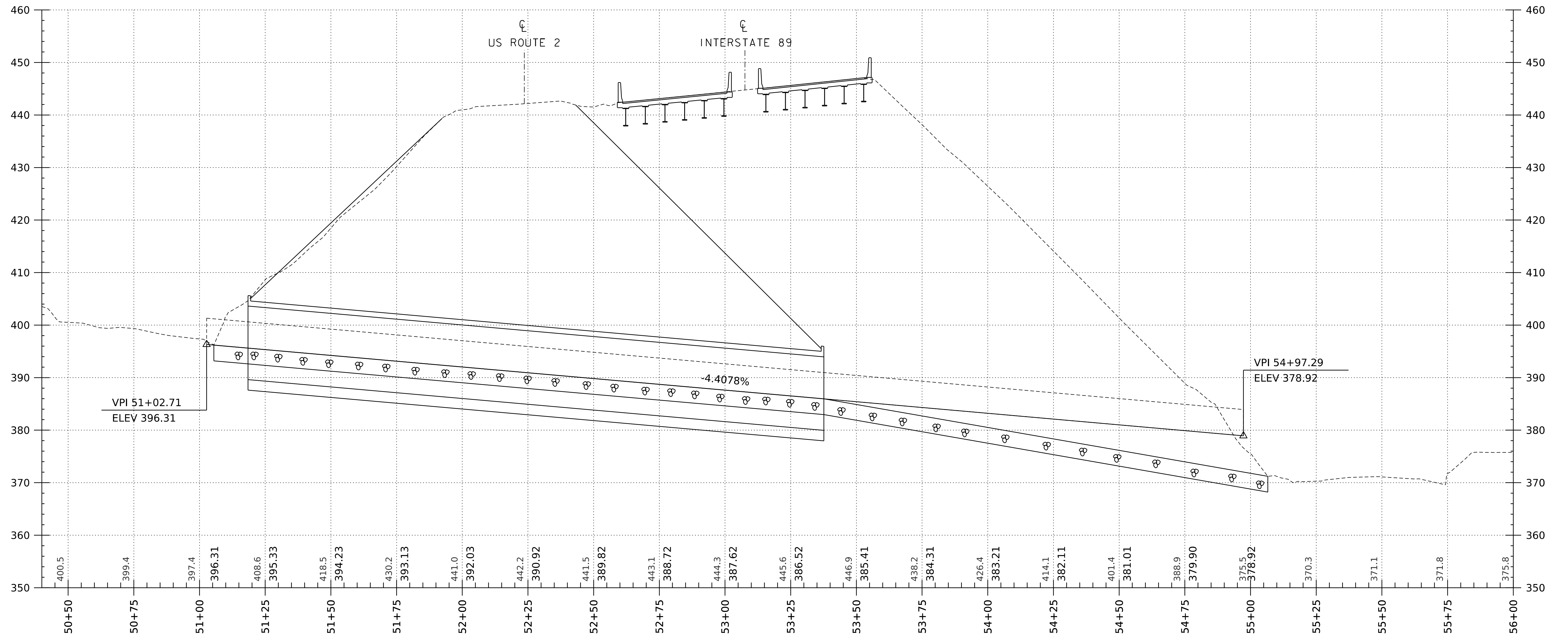

**NEW BRIDGES-PIPE ARCH PROFILE**

SCALE: HORIZONTAL 1"=20'-0"  
 VERTICAL 1"=10'-0"

NOTE:  
 GRADES SHOWN TO THE NEAREST TENTH ARE EXISTING GROUND ALONG  $\phi$   
 GRADES SHOWN TO THE NEAREST HUNDREDTH ARE FINISH GRADE ALONG  $\phi$

PROJECT NAME: WATERBURY	PLOT DATE: 28-JUN-2023
PROJECT NUMBER: IM CULV(109)	DRAWN BY: D.D.BEARD
FILE NAME: s22a107profile.dgn	CHECKED BY: -----
PROJECT LEADER: L.J.STONE	SHEET 35 OF 48
DESIGNED BY: -----	
NEW BRIDGES-PIPE ARCH PROFILE SHEET	

L = 600.00 FT  
 K = 1112  
 HSSD = INF FT  
 G1 = 3.1258% ; G2 = 3.6652%

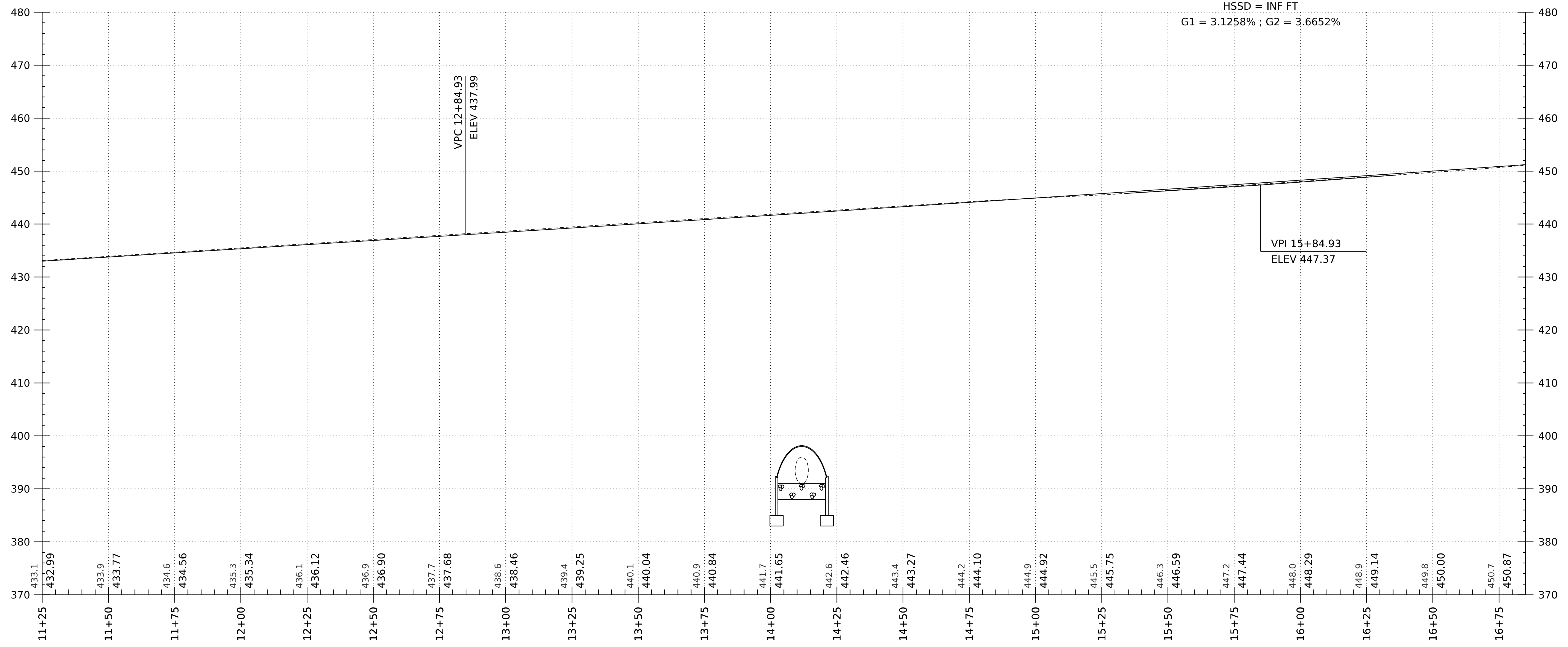

US ROUTE 2 PIPE ARCH PROFILE

SCALE: HORIZONTAL 1"=20'-0"  
 VERTICAL 1"=10'-0"

NOTE:  
 GRADES SHOWN TO THE NEAREST TENTH ARE EXISTING GROUND ALONG  $\phi$   
 GRADES SHOWN TO THE NEAREST HUNDREDTH ARE FINISH GRADE ALONG  $\phi$

PROJECT NAME:	WATERBURY
PROJECT NUMBER:	IM CULV(109)
FILE NAME:	s22a107profile.dgn
PROJECT LEADER:	L.J.STONE
DESIGNED BY:	-----
US ROUTE 2 PIPE ARCH PROFILE SHEET	
PLOT DATE:	28-JUN-2023
DRAWN BY:	D.D.BEARD
CHECKED BY:	-----
SHEET	36 OF 48

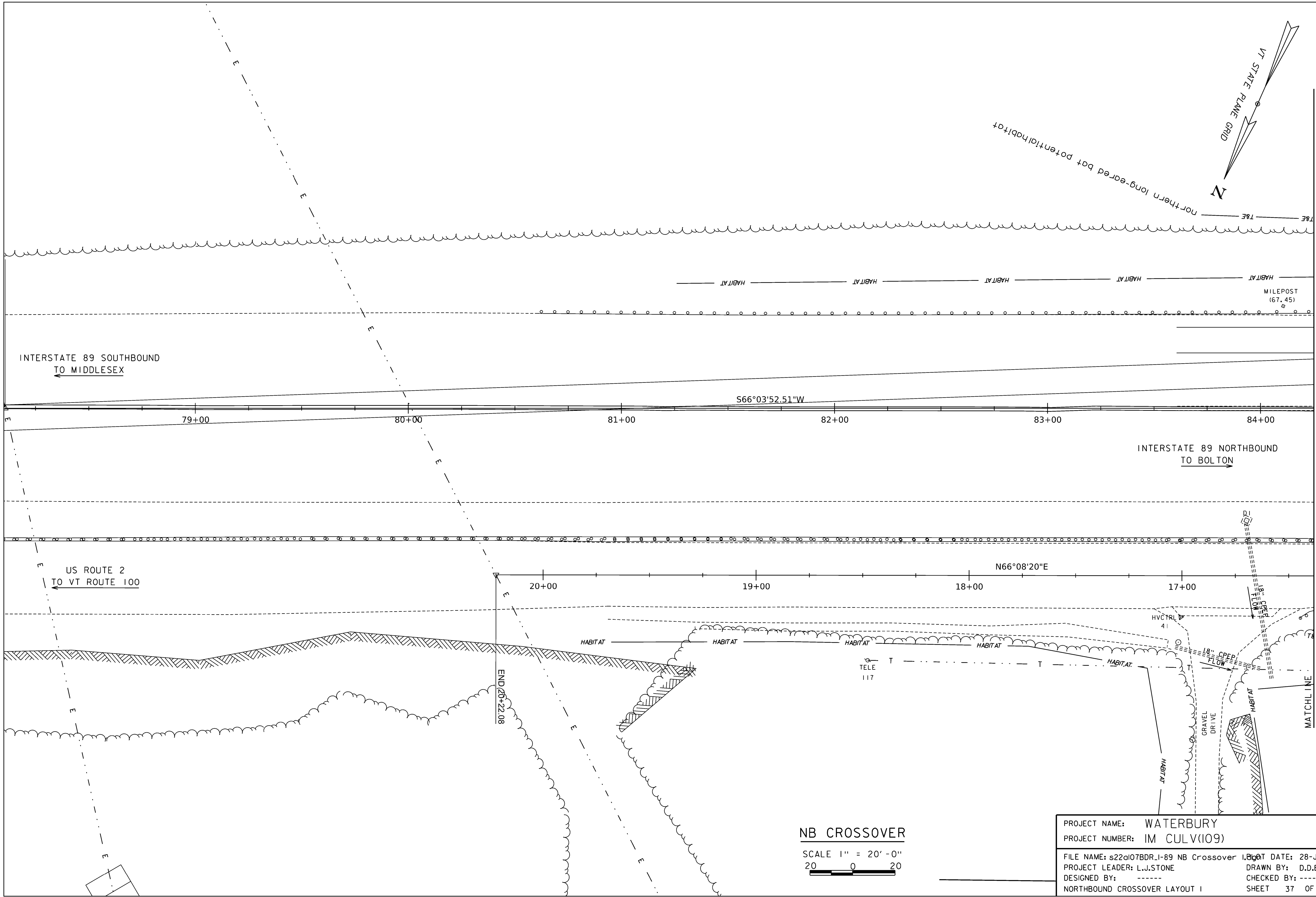

INTERSTATE 89 SOUTHBOUND  
TO MIDDLESEX

INTERSTATE 89 NORTHBOUND  
TO BOLTON

US ROUTE 2  
TO VT ROUTE 100

**NB CROSSOVER**

SCALE 1" = 20' - 0"  
20 0 20

PROJECT NAME:	WATERBURY		
PROJECT NUMBER:	IM CULV(109)		
FILE NAME:	s22a107BDR-I-89 NB Crossover I.0160	DATE:	28-JUN-2023
PROJECT LEADER:	L.J.STONE	DRAWN BY:	D.D.BEARD
DESIGNED BY:	-----	CHECKED BY:	-----
NORTHBOUND CROSSOVER LAYOUT 1		SHEET 37 OF 48	

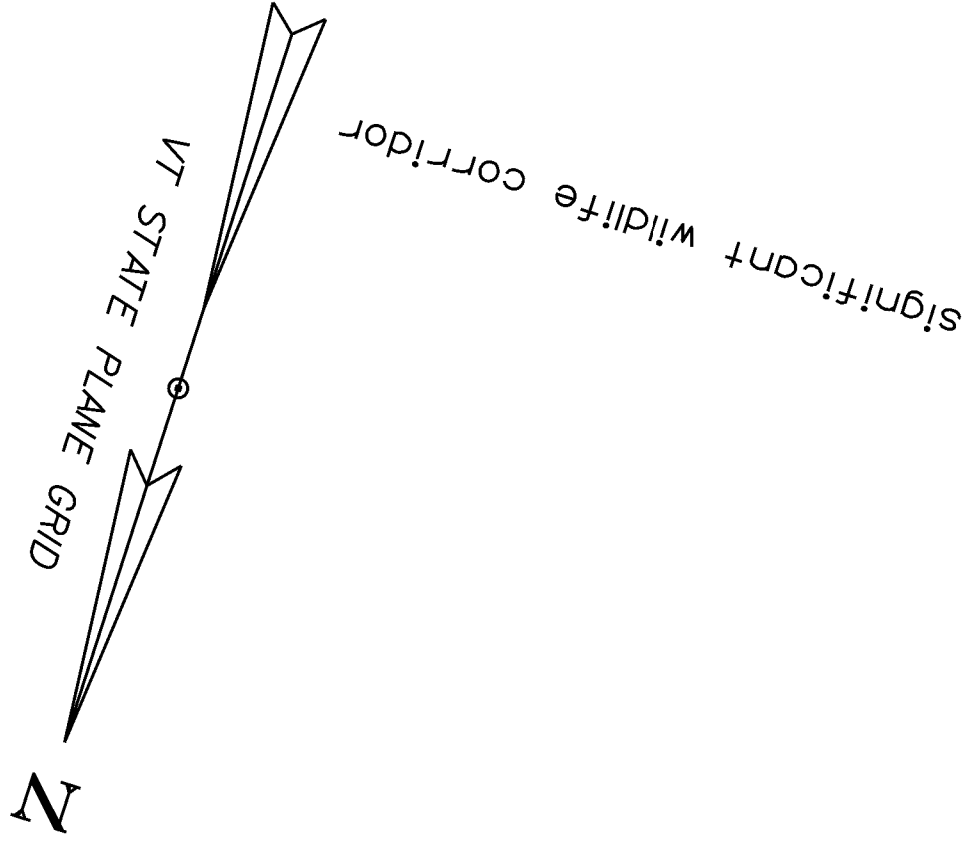

BENCHMARK  
CHISELED SQUARE ON TOP  
OF CONCRETE SIGN BASE  
ELEV. = 438.62

1-89 86+87.85=  
CHAN 53+07.58  
 $\Delta = 73^{\circ}01'35''RT$

MILEPOST  
(67.50)

SIGN  
(ALL TRUCKS  
NEXT RIGHT)

MILEPOST  
(67.55)

INTERSTATE 89 SOUTHBOUND  
TO MIDDLESEX

INTERSTATE 89 NORTHBOUND  
TO BOLTON

US ROUTE 2  
TO VT ROUTE 100

US ROUTE 2  
TO BOLTON

US-2 14+11.75  
CHAN 52+23.60  
 $\Delta = 113^{\circ}05'10''LT$

MATCHLINE  
STA 84+25

MATCHLINE  
STA 89+75

NB CROSSOVER

SCALE 1" = 20'-0"  
20 0 20

PROJECT NAME:	WATERBURY
PROJECT NUMBER:	IM 089-2(57)
FILE NAME:	22a107BDR-I-89 NB Crossover 2.dwg
DATE:	28-JUN-2023
PROJECT LEADER:	L.J.STONE
DESIGNED BY:	-----
DRAWN BY:	D.D.BEARD
CHECKED BY:	-----
I-89 NORTHBOUND CROSSOVER LAYOUT 2	SHEET 38 OF 48

BROKEN CONCRETE  
BOUNDARY MARKER  
REBAR UP 4"



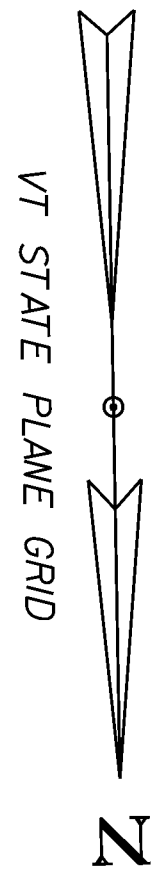

e = 201.98  
28.51

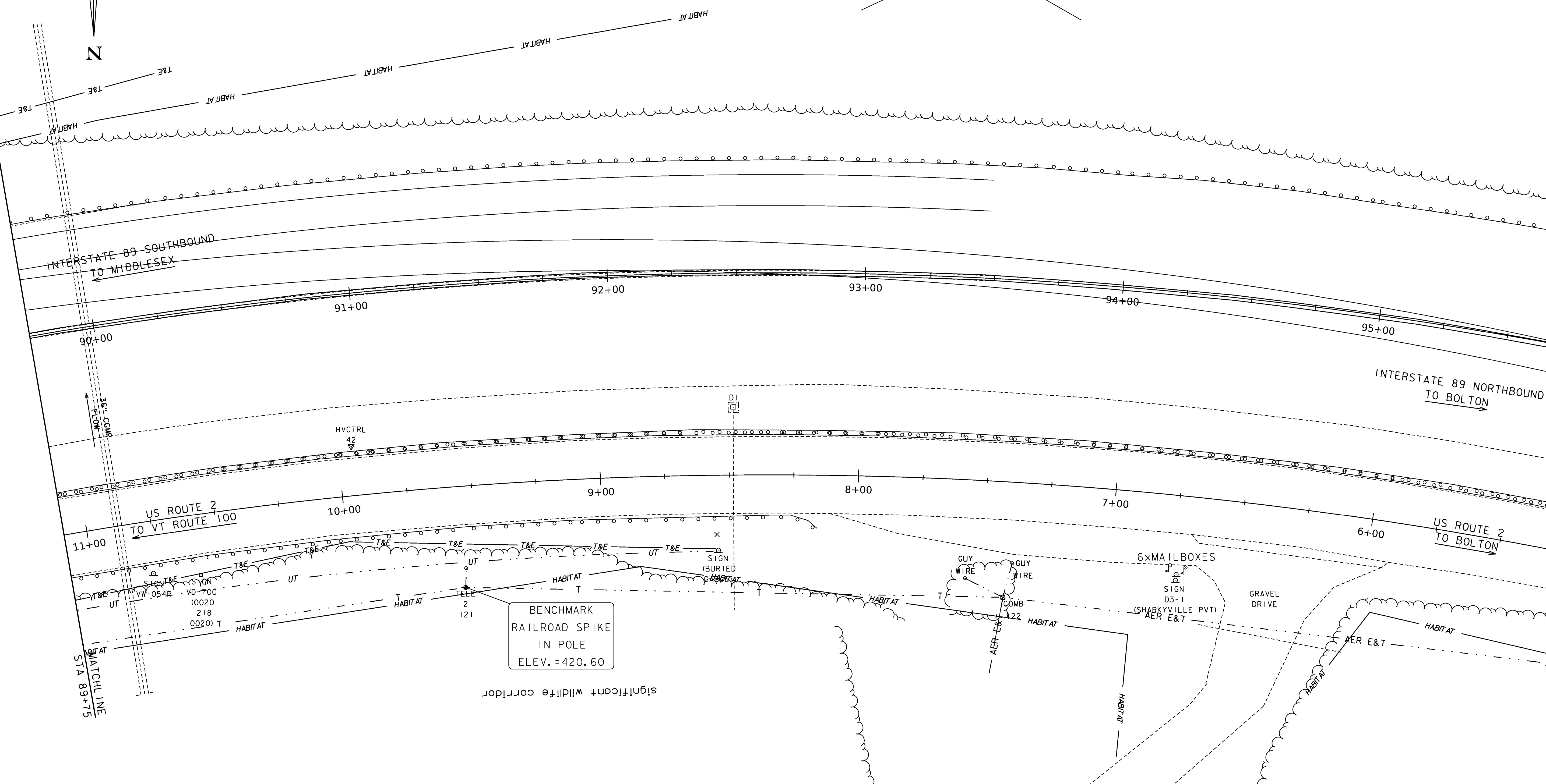

INTERSTATE 89 SOUTHBOUND  
TO MIDDLESEX

INTERSTATE 89 NORTHBOUND  
TO BOLTON

US ROUTE 2  
TO VT ROUTE 100

US ROUTE 2  
TO BOLTON

BENCHMARK  
RAILROAD SPIKE  
IN POLE  
ELEV. = 420.60

significant wildlife corridor

MATCHLINE  
STA 89+75

NB CROSSOVER

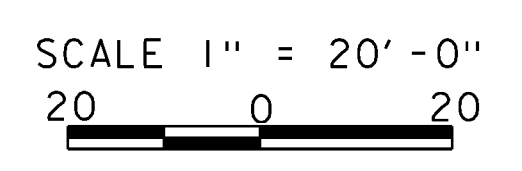

PROJECT NAME:	WATERBURY		
PROJECT NUMBER:	IM CULV(109)		
FILE NAME:	s22o107BDR-I-89 NB Crossover 39.dwg	DATE:	28-JUN-2023
PROJECT LEADER:	L.J.STONE	DRAWN BY:	D.D.BEARD
DESIGNED BY:	-----	CHECKED BY:	-----
I-89 NORTHBOUND CROSSOVER LAYOUT 3		SHEET	39 OF 48

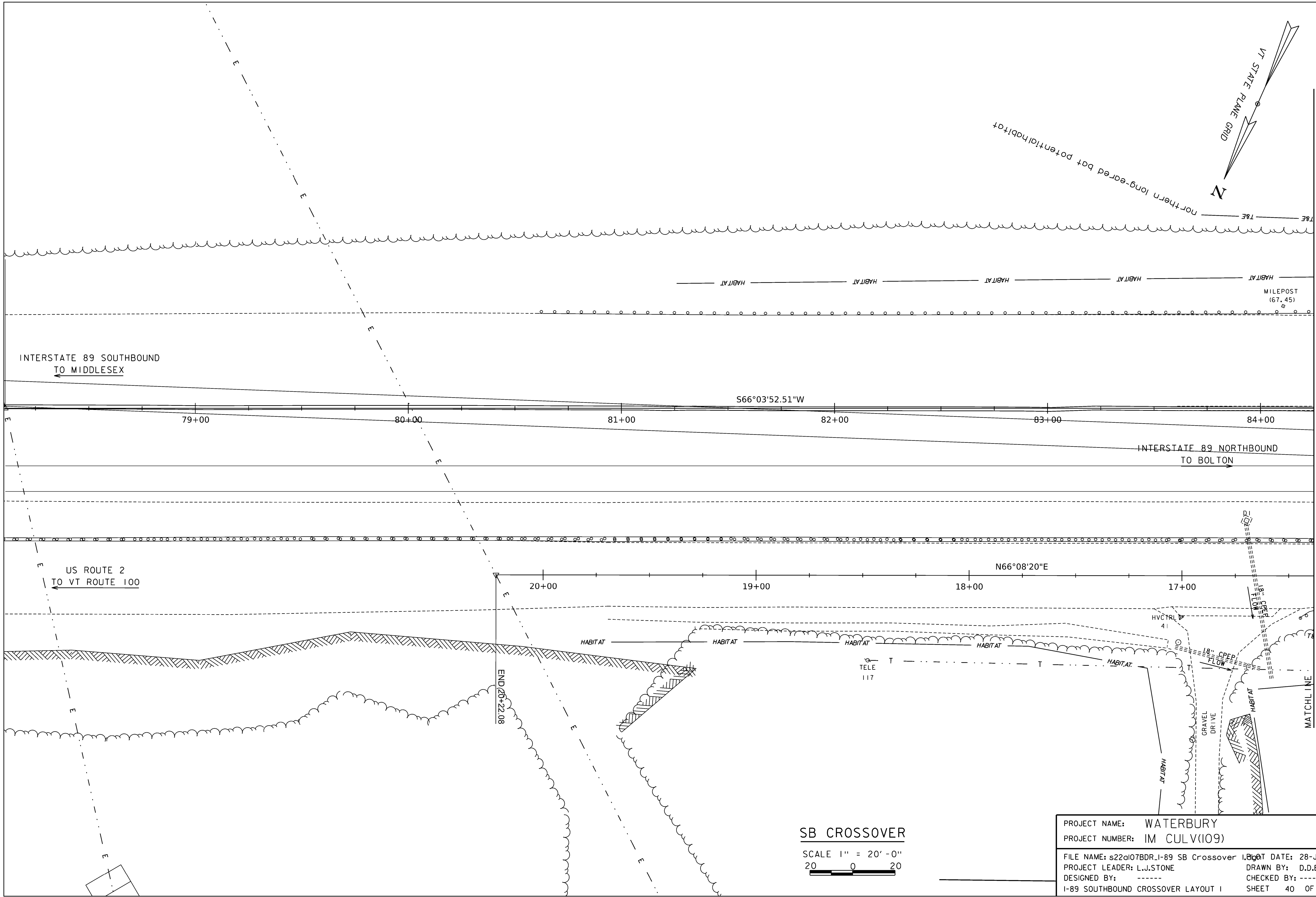

INTERSTATE 89 SOUTHBOUND  
TO MIDDLESEX

INTERSTATE 89 NORTHBOUND  
TO BOLTON

US ROUTE 2  
TO VT ROUTE 100

S66°03'52.51"W

N66°08'20"E

END 20+22.08

MATCHLINE  
STA 84+25

**SB CROSSOVER**

SCALE 1" = 20' - 0"  
20 0 20

PROJECT NAME:	WATERBURY		
PROJECT NUMBER:	IM CULV(109)		
FILE NAME:	s22a107BDR-I-89 SB Crossover I.010	DATE:	28-JUN-2023
PROJECT LEADER:	L.J.STONE	DRAWN BY:	D.D.BEARD
DESIGNED BY:	-----	CHECKED BY:	-----
I-89 SOUTHBOUND CROSSOVER LAYOUT I		SHEET	40 OF 48



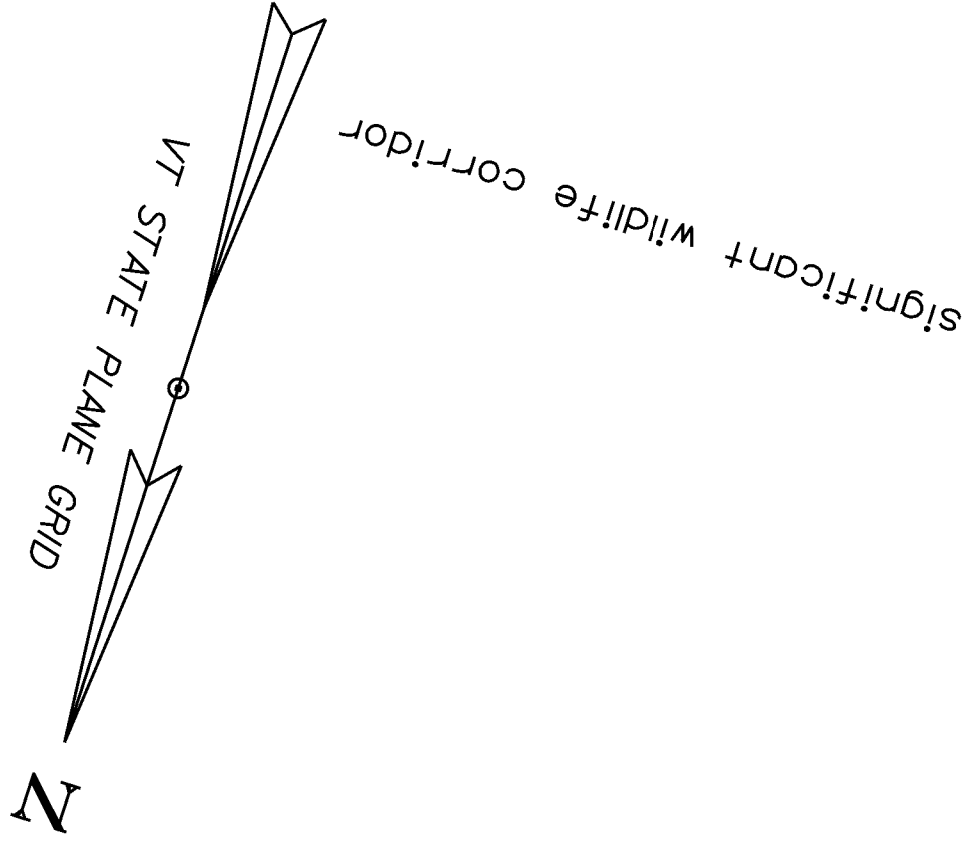

BENCHMARK  
 CHISELED SQUARE ON TOP  
 OF CONCRETE SIGN BASE  
 ELEV. = 438.62

1-89 86+87.85=  
 CHAN 53+07.58  
 $\Delta = 73^{\circ}01'35''\text{RT}$

US-2 14+11.75=  
 CHAN 52+23.60  
 $\Delta = 113^{\circ}05'10''\text{LT}$

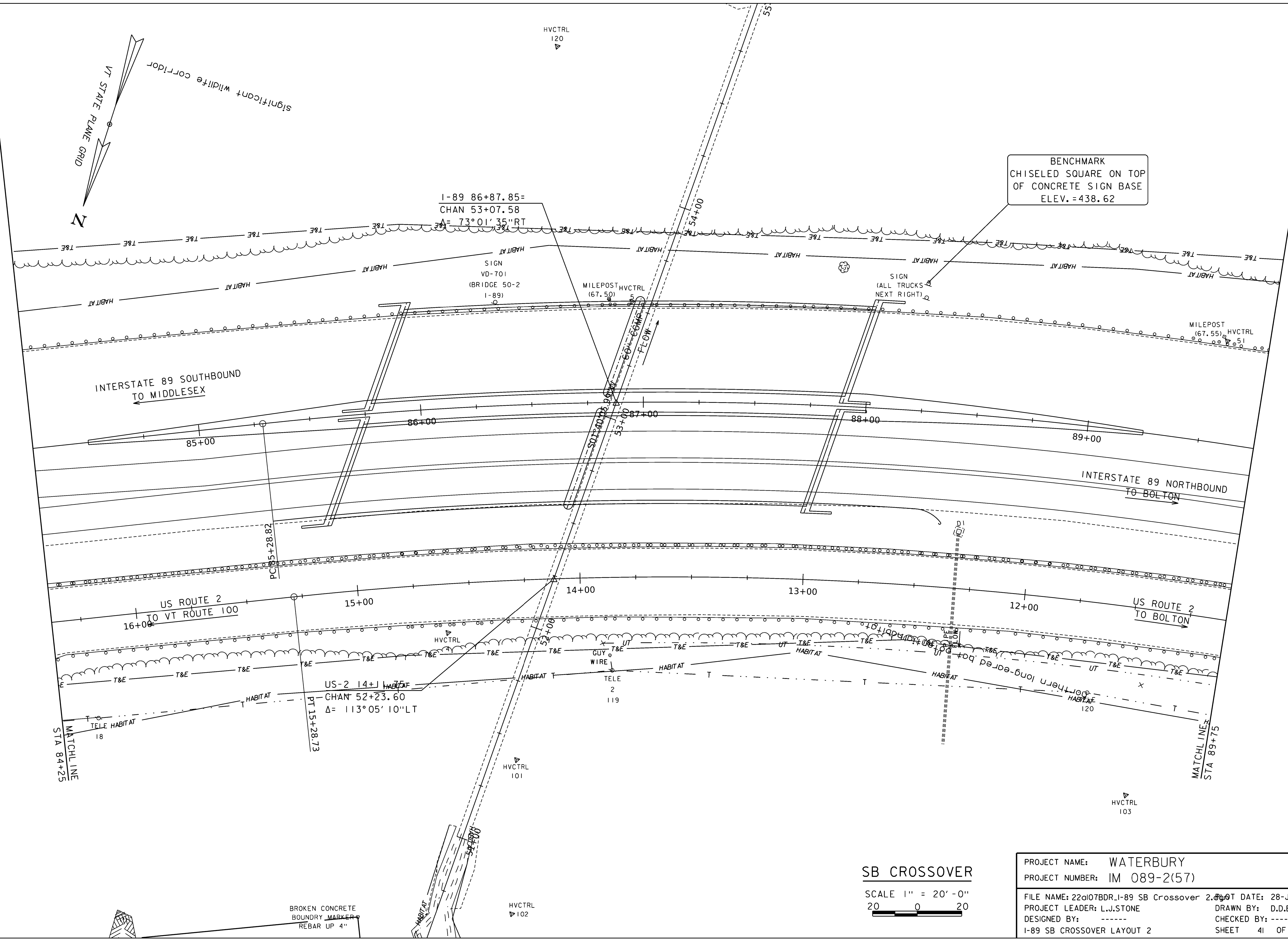

INTERSTATE 89 SOUTHBOUND  
 TO MIDDLESEX

INTERSTATE 89 NORTHBOUND  
 TO BOLTON

US ROUTE 2  
 TO VT ROUTE 100

US ROUTE 2  
 TO BOLTON

**SB CROSSOVER**

SCALE 1" = 20'-0"  
 20 0 20

PROJECT NAME:	WATERBURY	DATE:	28-JUN-2023
PROJECT NUMBER:	IM 089-2(57)	DRAWN BY:	D.D.BEARD
FILE NAME:	22a107BDR-I-89 SB Crossover 2.dwg	CHECKED BY:	-----
PROJECT LEADER:	L.J.STONE		
DESIGNED BY:	-----		
I-89 SB CROSSOVER LAYOUT 2		SHEET 41 OF 48	

BROKEN CONCRETE  
 BOUNDARY MARKER  
 REBAR UP 4"

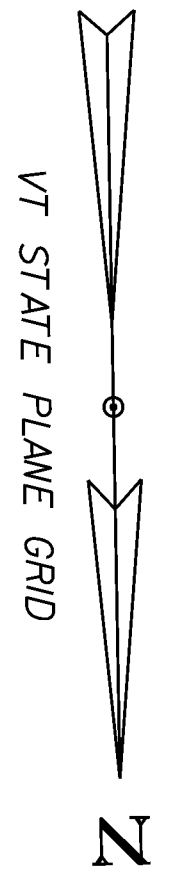

e = 201.98  
28.51

INTERSTATE 89 SOUTHBOUND  
TO MIDDLESEX

INTERSTATE 89 NORTHBOUND  
TO BOLTON

US ROUTE 2  
TO VT ROUTE 100

US ROUTE 2  
TO BOLTON

BENCHMARK  
RAILROAD SPIKE  
IN POLE  
ELEV. = 420.60

significant wildlife corridor

MATCHLINE  
STA 89+75

SB CROSSOVER

SCALE 1" = 20'-0"  
20 0 20

PROJECT NAME:	WATERBURY
PROJECT NUMBER:	IM CULV(109)
FILE NAME:	s220107BDR-I-89 SB Crossover 3R.dwg
DATE:	28-JUN-2023
PROJECT LEADER:	L.J.STONE
DRAWN BY:	D.D.BEARD
DESIGNED BY:	-----
CHECKED BY:	-----
I-89 SOUTHBOUND CROSSOVER LAYOUT 3	SHEET 42 OF 48

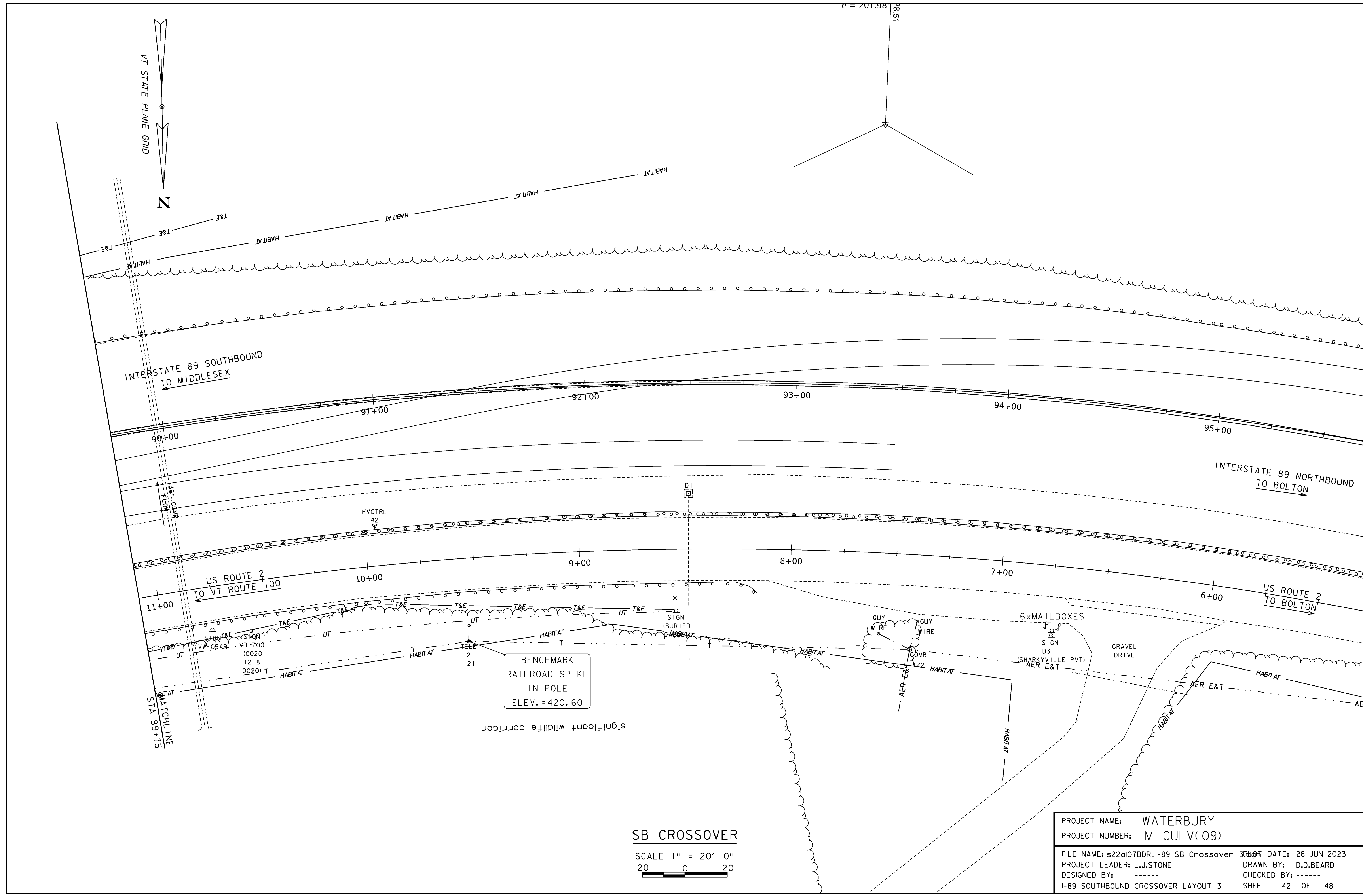

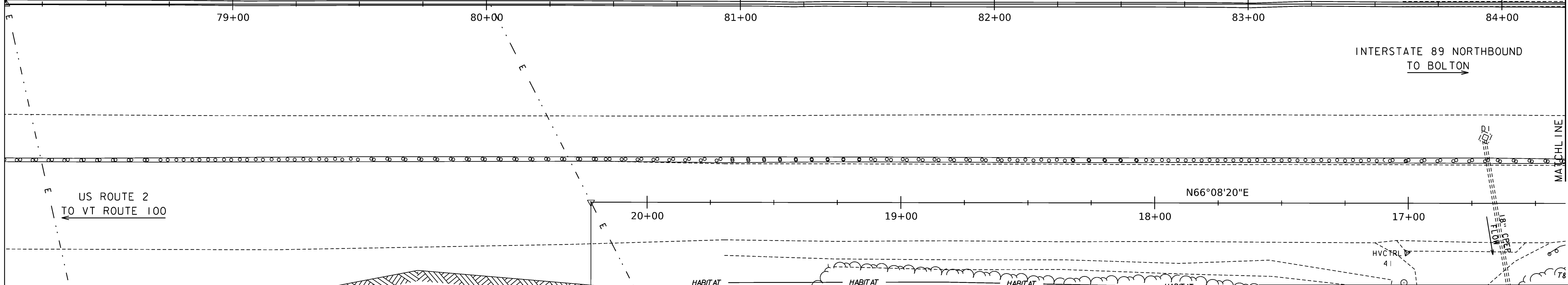
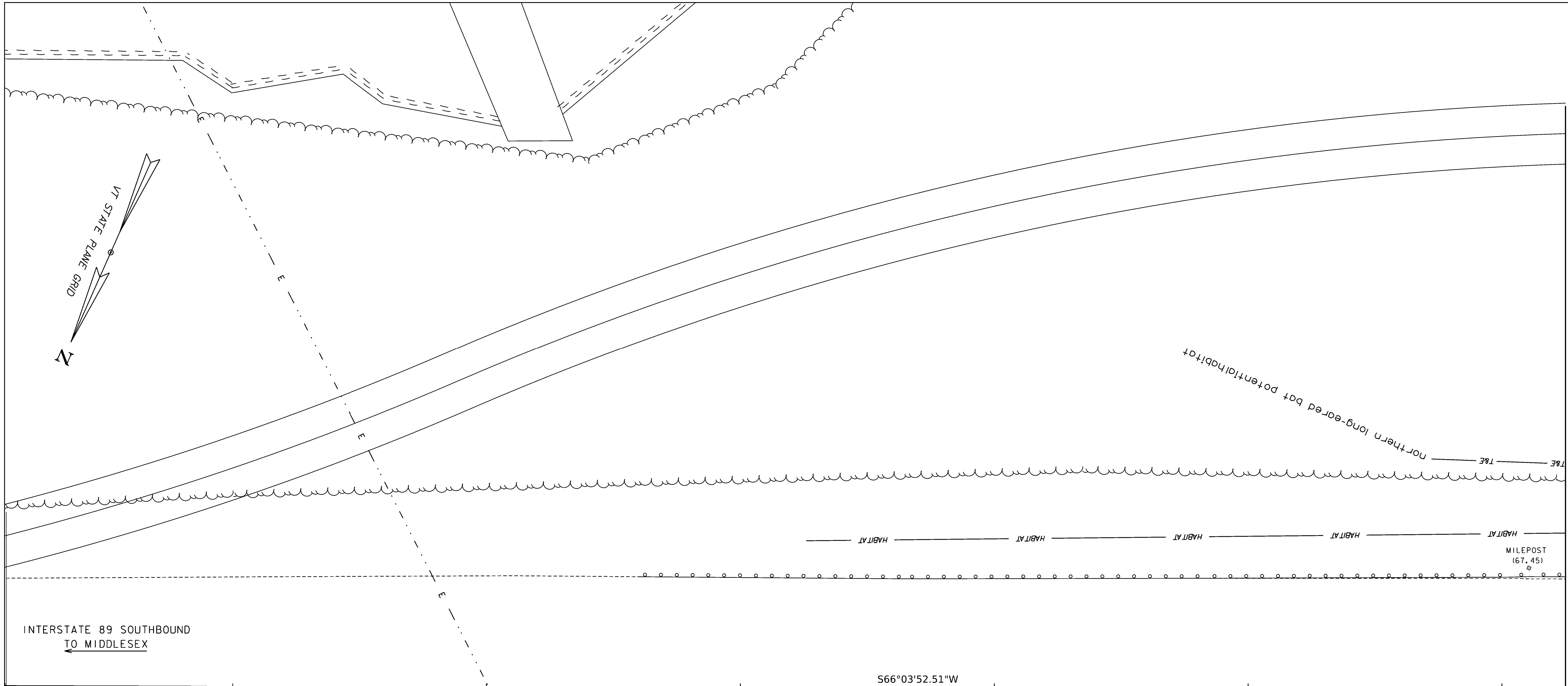

**I-89 TEMPORARY BRIDGE**

SCALE 1" = 20'-0"  
 20 0 20

PROJECT NAME:	WATERBURY
PROJECT NUMBER:	IM CULV(109)
FILE NAME:	s22a107BDR-I-89 Temp Bridge I.dwg
DESIGNED BY:	-----
DRAWN BY:	D.D.BEARD
CHECKED BY:	-----
SHEET	43 OF 48
DATE:	28-JUN-2023

northern long-eared bat potential habitat

INTERSTATE 89 SOUTHBOUND  
TO MIDDLESEX

INTERSTATE 89 NORTHBOUND  
TO BOLTON

US ROUTE 2  
TO VT ROUTE 100

MATCH LINE  
STA 84+25

END 20+22.08

MILEPOST  
(67.45)

S66°03'52.51"W

N66°08'20"E

HVCTRL  
41

# I-89 TEMPORARY BRIDGE

SCALE 1" = 20'-0"  
20 0 20

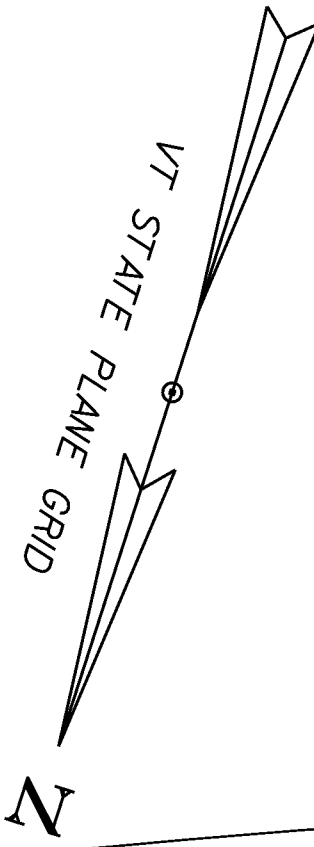

Significant wildlife corridor

UNNAMED BROOK  
FLOW

BENCHMARK  
CHISELED SQUARE ON TOP  
OF CONCRETE SIGN BASE  
ELEV. = 438.62

INTERSTATE 89 SOUTHBOUND  
TO MIDDLESEX

INTERSTATE 89 NORTH  
TO BOLTON

US ROUTE 2  
TO VT ROUTE 100

PROJECT NAME:	WATERBURY
PROJECT NUMBER:	IM 089-2(57)
FILE NAME:	22a107BDR-I-89 Temp Bridge 2.dgn
DATE:	28-JUN-2023
PROJECT LEADER:	L.J.STONE
DESIGNED BY:	-----
I-89 TEMPORARY BRIDGE LAYOUT 2	
DRAWN BY:	D.D.BEARD
CHECKED BY:	-----
SHEET	44 OF 48

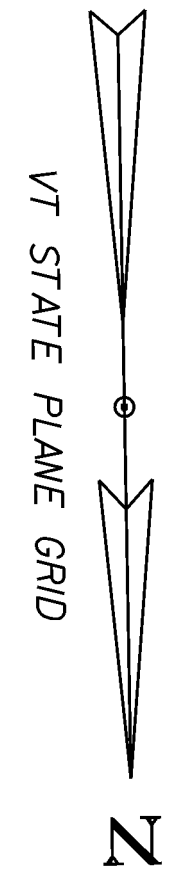

CURVE (x)  
DELTA = 54°48'07"  
D = 03°35'05"  
R = 1598.30'  
T = 828.51'  
L = 1528.73'  
e = 201.98'

HPI 8+28.51

INTERSTATE 89 SOUTHBOUND  
TO MIDDLESEX

INTERSTATE 89 NORTHBOUND  
TO BOLTON

US ROUTE 2  
TO VT ROUTE 100

US ROUTE 2  
TO BOLTON

STA 89+75

BENCHMARK  
RAILROAD SPIKE  
IN POLE  
ELEV. = 420.60

I-89 TEMPORARY BRIDGE

SCALE 1" = 20'-0"  
20 0 20

PROJECT NAME:	WATERBURY
PROJECT NUMBER:	IM CULV(109)
FILE NAME:	s22a107BDR-I-89 Temp Bridge 3.dwg
DATE:	28-JUN-2023
PROJECT LEADER:	L.J.STONE
DESIGNED BY:	-----
DRAWN BY:	D.D.BEARD
CHECKED BY:	-----
I-89 TEMPORARY BRIDGE LAYOUT 3	SHEET 45 OF 48

significant wildlife corridor

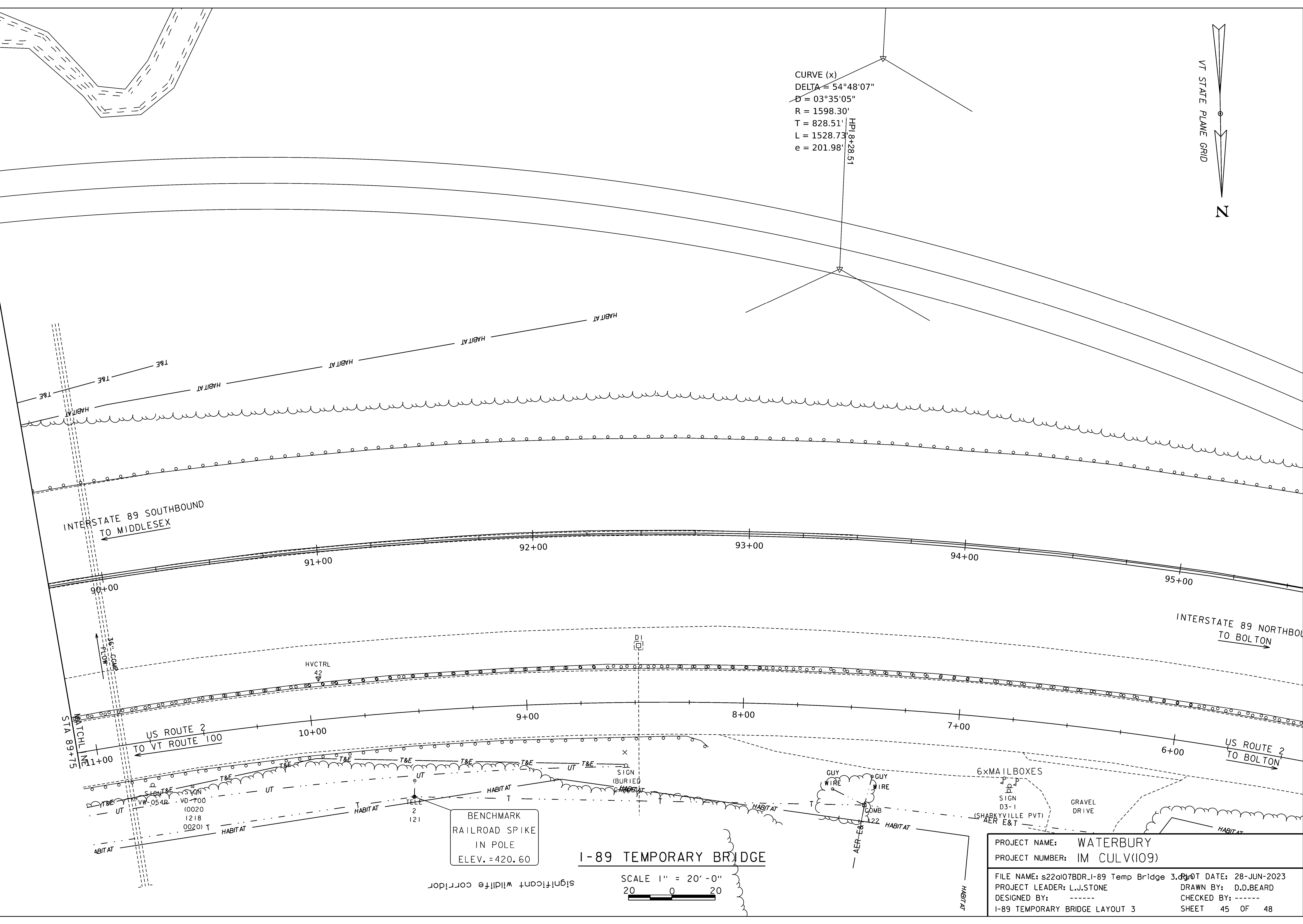

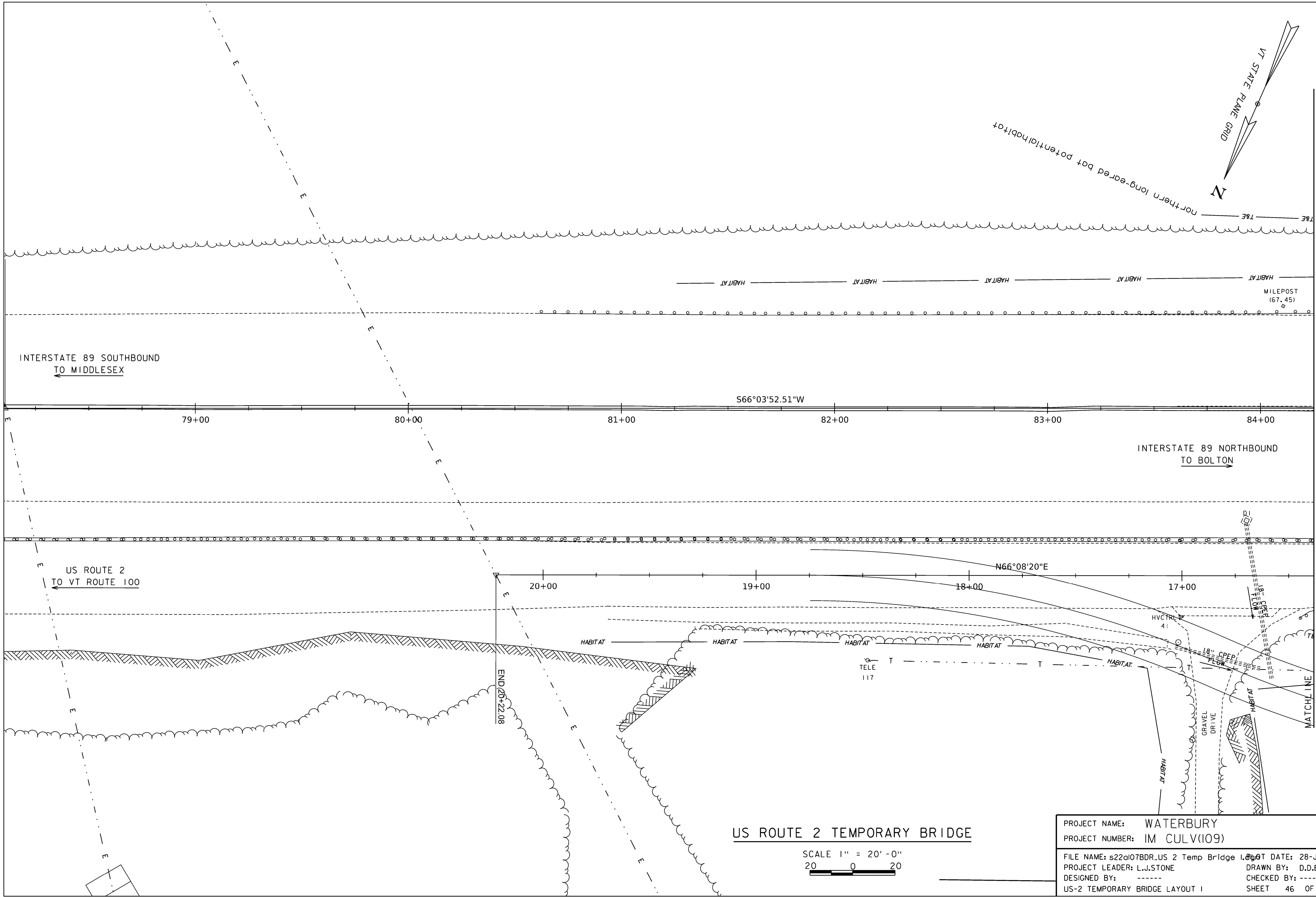

INTERSTATE 89 SOUTHBOUND  
TO MIDDLESEX

S66°03'52.51"W

INTERSTATE 89 NORTHBOUND  
TO BOLTON

US ROUTE 2  
TO VT ROUTE 100

N66°08'20"E

END 20+22.08

MATCHLINE  
STA 84+25

**US ROUTE 2 TEMPORARY BRIDGE**

SCALE 1" = 20' - 0"  
20 0 20

PROJECT NAME:	WATERBURY		
PROJECT NUMBER:	IM CULV(109)		
FILE NAME:	s22a107BDR.US 2 Temp Bridge	DATE:	28-JUN-2023
PROJECT LEADER:	L.J.STONE	DRAWN BY:	D.D.BEARD
DESIGNED BY:	-----	CHECKED BY:	-----
US-2 TEMPORARY BRIDGE LAYOUT 1		SHEET	46 OF 48

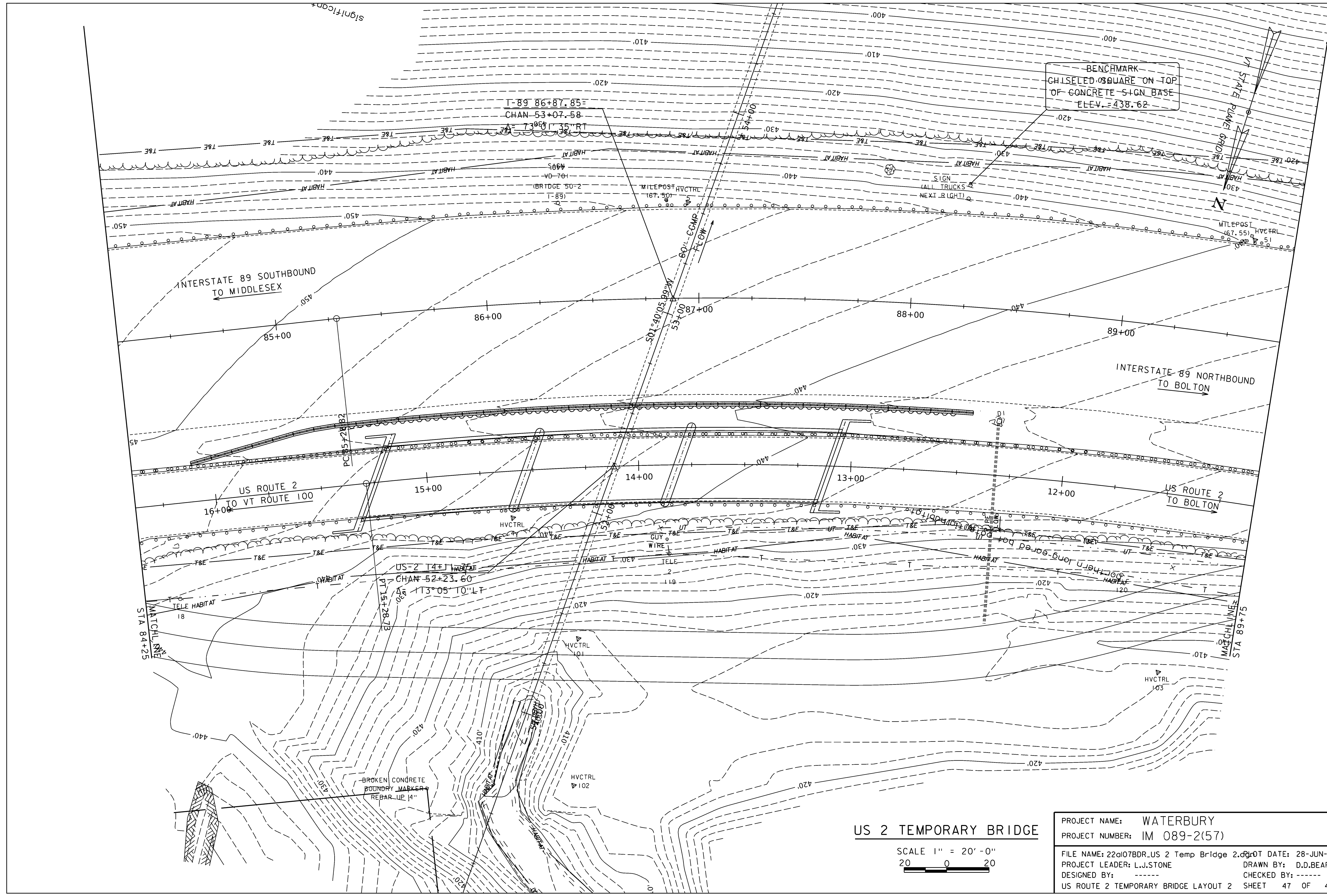

**US 2 TEMPORARY BRIDGE**

SCALE 1" = 20'-0"  
 20 0 20

PROJECT NAME:	WATERBURY
PROJECT NUMBER:	IM 089-2(57)
FILE NAME:	22a107BDR_US 2 Temp Bridge 2.dwg
DATE:	28-JUN-2023
PROJECT LEADER:	L.J.STONE
DRAWN BY:	D.D.BEARD
DESIGNED BY:	-----
CHECKED BY:	-----
US ROUTE 2 TEMPORARY BRIDGE LAYOUT 2	SHEET 47 OF 48

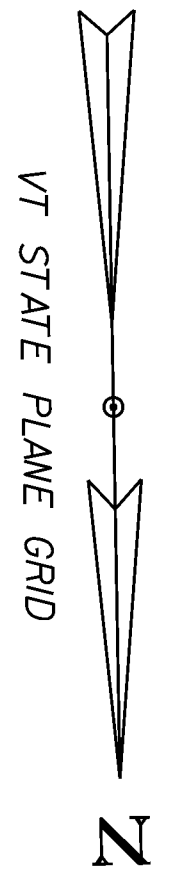

e = 201.98  
28.51

INTERSTATE 89 SOUTHBOUND  
TO MIDDLESEX

INTERSTATE 89 NORTHBOUND  
TO BOLTON

US ROUTE 2  
TO VT ROUTE 100

US ROUTE 2  
TO BOLTON

BENCHMARK  
RAILROAD SPIKE  
IN POLE  
ELEV. = 420.60

significant wildlife corridor

### US 2 TEMPORARY BRIDGE

SCALE 1" = 20'-0"  
20 0 20

PROJECT NAME:	WATERBURY		
PROJECT NUMBER:	IM CULV(109)		
FILE NAME:	s22o107BDR.US 2 Temp Bridge 3 Right	DATE:	28-JUN-2023
PROJECT LEADER:	L.J.STONE	DRAWN BY:	D.D.BEARD
DESIGNED BY:	-----	CHECKED BY:	-----
US 2 TEMPORARY BRIDGE LAYOUT 3		SHEET 48 OF 48	

